

IC34 SPRAYER JOB COMPUTER USER MANUAL

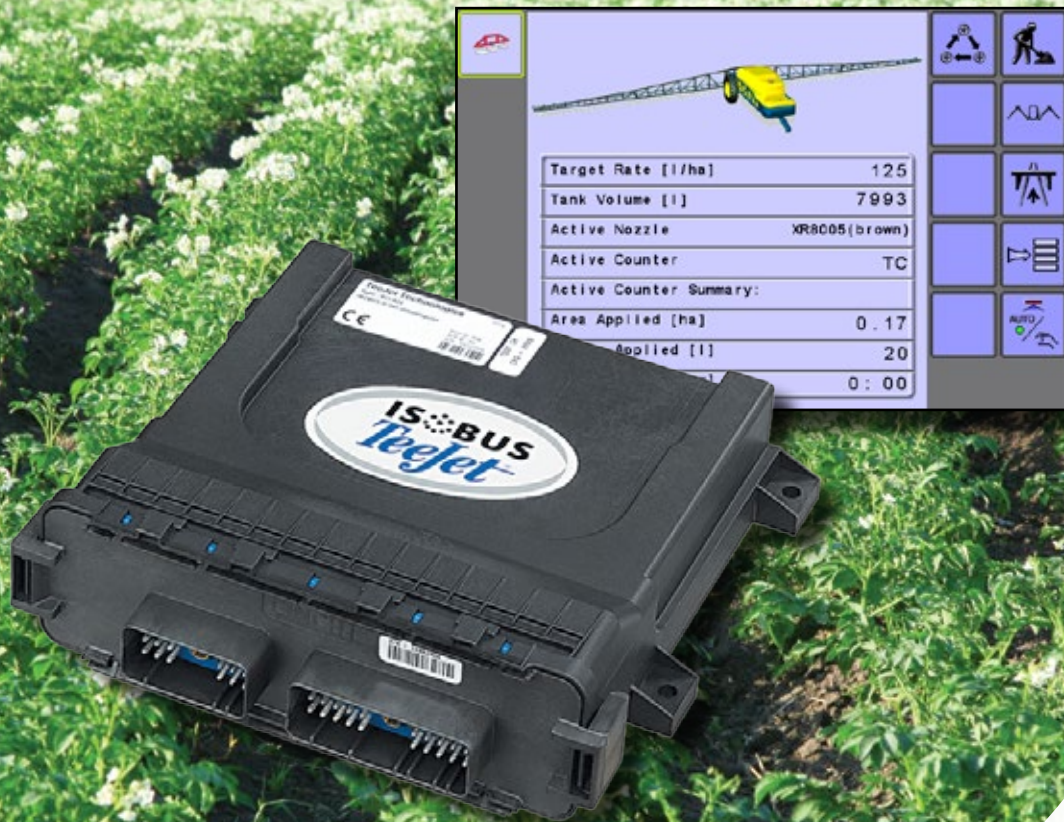

Software version 1.16-1.19



A Subsidiary of  Spraying Systems Co.®

COPYRIGHTS

© 2017 TeeJet Technologies. All rights reserved. No part of this document or the computer programmes described in it may be reproduced, copied, photocopied, translated, or reduced in any form or by any means, electronic or machine readable, recording or otherwise, without prior written consent from TeeJet Technologies.

TRADEMARKS

Unless otherwise noted, all other brand or product names are trademarks or registered trademarks of their respective companies or organisations.

LIMITATION OF LIABILITY

TEEJET TECHNOLOGIES PROVIDES THIS MATERIAL "AS IS" WITHOUT WARRANTY OF ANY KIND, EITHER EXPRESSED OR IMPLIED. NO COPYRIGHT LIABILITY OR PATENT IS ASSUMED. IN NO EVENT SHALL TEEJET TECHNOLOGIES BE LIABLE FOR ANY LOSS OF BUSINESS, LOSS OF PROFIT, LOSS OF USE OR DATA, INTERRUPTION OF BUSINESS, OR FOR INDIRECT, SPECIAL, INCIDENTAL, OR CONSEQUENTIAL DAMAGES OF ANY KIND, EVEN IF TEEJET TECHNOLOGIES HAS BEEN ADVISED OF SUCH DAMAGES ARISING FROM TEEJET TECHNOLOGIES SOFTWARE.

To ensure optimal use of the equipment, please read this manual thoroughly. Please contact TeeJet Technologies Customer Support or an authorized TeeJet Technologies dealer if additional support is required.

RESPONSIBILITY FOR USE OF THIS PRODUCT

Regarding responsibility for use of this product, we refer to our sales and delivery terms which states:

Product Usage

Any use of the product is at the sole risk of the buyer. The buyer is therefore not entitled to any form for compensation caused by, for example, any of the following:

- ▶ Disturbance to/from any electronic services or products that do not conform to the standards for CE marketing;
- ▶ Missing or poor signal coverage or a succession hereof from external transmitters/receivers used by the buyer; Functional faults which apply to or from a PC-programme or PC equipment not delivered by the seller;
- ▶ Faults that may arise from the buyers' negligence to react to warnings and fault messages from the product or that can be traced to negligence and/or absent constant control of the work carried out in comparison to the planned job.

When implementing any new equipment the buyer must take great care and pay attention. Any doubts as to the correct operation/use should result in contacting the seller's service department.

Table of contents

CHAPTER 1 – INTRODUCTION	1	INTRODUCTION
OPTIONAL SYSTEM COMPONENTS	1	
ISOBUS switchbox	1	
START UP	3	
HOME SCREEN	3	OPERATION
OPERATION MODE	4	
MAIN SETUP SCREEN	5	
SETTING OPTIONS NAVIGATION	6	
CHAPTER 2 – OPERATION MODE	7	TC/TRIP
AUTOMATIC OR MANUAL REGULATION MODE	7	
OPERATION MODE OVERVIEW	8	
APPLICATION RATE OPTIONS	12	FOLDING
Target rate	12	
Target Rate/Step Percentage Increase/Decrease	12	
Regulation Valve Manual Open/Close.....	12	
BOOM SECTIONS	13	
Start/stop application	13	
Boom sections on/off.....	14	
INFORMATION	15	TRANSPORT
CHAPTER 3 – TRIP TOGGLE / TASK CONTROLLER	16	
TRIP MODE	16	
TASK CONTROLLER MODE	16	
CHAPTER 4 – FOLDING	17	SETUP
CHAPTER 5 – TRANSPORT	19	
CHAPTER 6 – SETUP	20	APPENDIX
Main menu structure.....	20	
COUNTERS	21	
Campaign counters.....	23	
Total counters	23	
Export counters.....	23	
JOB PARAMETERS	24	

ISOBUS Job Computer: IC34 Sprayer

MACHINE 25

Filling.....	26
Operation	26
Implement parameters.....	27
Section width	27
Nozzle preset setup	27
Regulation parameters	28
Shortened sections	29
Calibrations.....	30
Flow sensor.....	30
Fill flow sensor	31
Liquid pressure sensor	31
Implement speed sensor	32
Tank level sensor	33
Wind speed sensor	35
Alarm configurations.....	35
OEM	36

USER INTERFACE 37

HELP 38

Test input	38
Test output	38
PowerLink+	39
UT.....	39
TECU.....	39
About	40

PC COMMUNICATION 40

APPENDIX A - FACTORY SETTINGS & RANGES 41

JOB PARAMETERS 41

MACHINE 41

Tank filling	41
Operation	42
Implement parameters.....	42
Calibrations	43
Alarm configurations.....	44

USER INTERFACE 44

APPENDIX B - UNIT SPECIFICATIONS 44

CHAPTER 1– INTRODUCTION

Congratulations on the purchase of your new IC34 ECU built on the ISOBUS architecture. When used within the guidelines of this manual, the IC34 controller will be a reliable application tool. This manual covers the sprayer functions of the IC34 ECU.

Use with your existing universal terminal (UT)

- Works seamlessly and displays on any ISOBUS UT
- Easy navigation menu and data rich display
- IC34 Sprayer ECU suitable for use with liquid fertiliser
- Automatic boom section control
- Variable rate control available providing your UT has GNSS and task control capability
- Add additional ISOBUS ECUs as your needs change
- Provides advanced rate control
- Standardised plugs, cables and software simplify installation and connectivity. IC34 ECU resides on the implement, reducing hardware in the cab

Figure 1-1: IC34 job computer



OPTIONAL SYSTEM COMPONENTS

ISOBUS switchbox

Manual and automatic 15 section control as well as hydraulic/electrical functions. Switchbox offers nine (9) section switches. In case of more sections they will automatically be distributed across the nine (9) switches. Automatic section control will always offer automatic control of the individual sections. Hydraulic functions can be defined by the OEM and distributed across nine (9) switches / 18 positions with dual levels to obtain as many as 36 functions.

Figure 1-2: Switchbox – nine (9) sections and master output

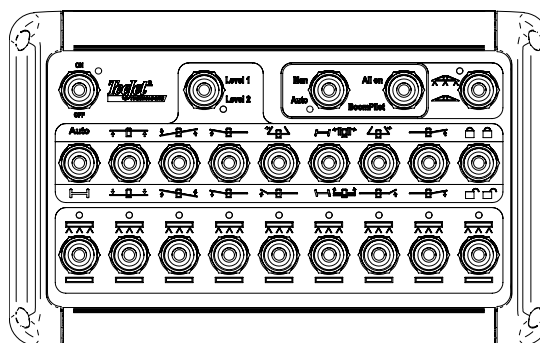
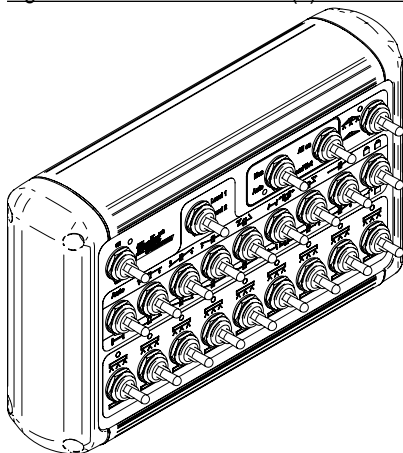

ISOBUS Job Computer: IC34 Sprayer

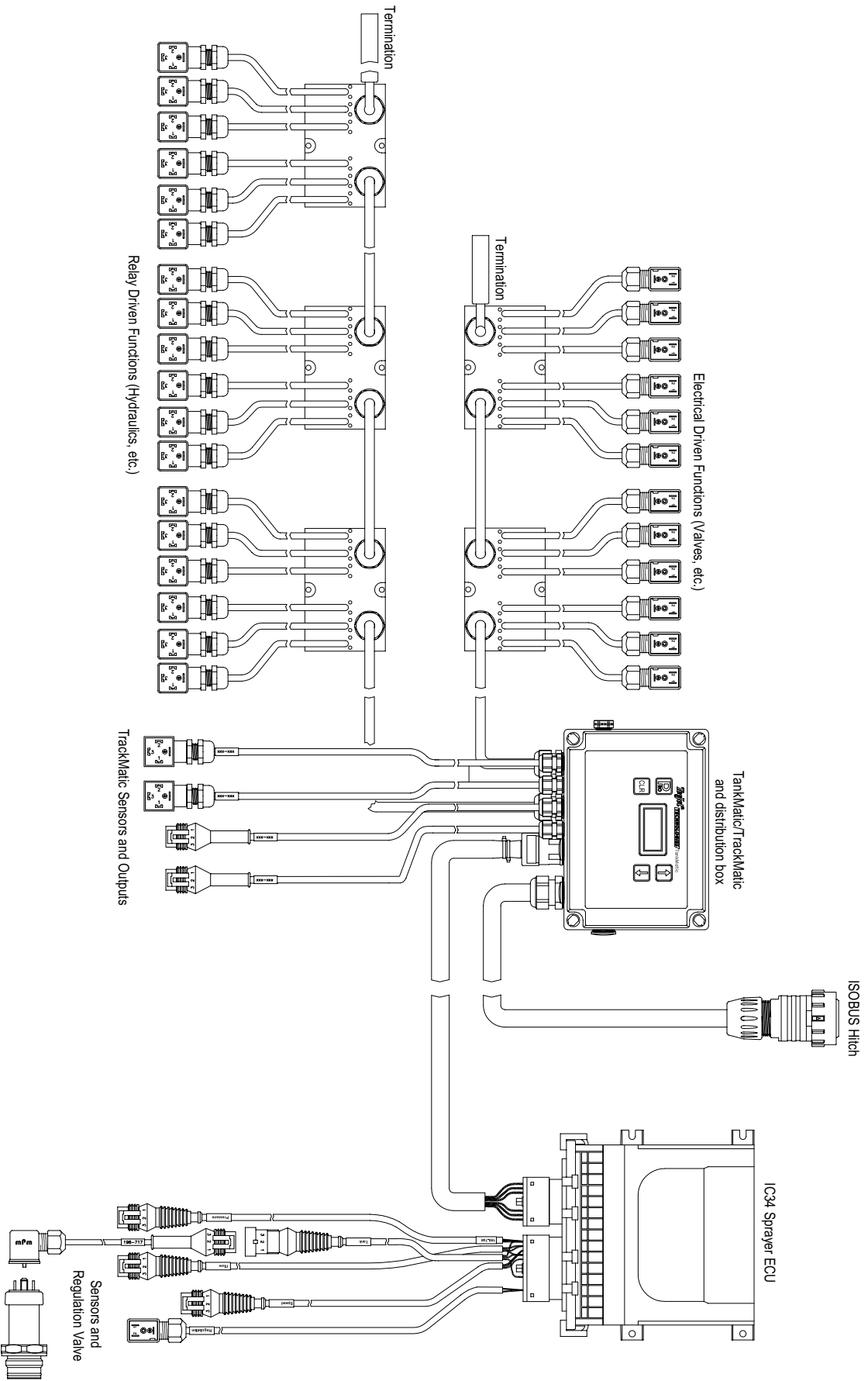

Figure 1-3: IC34 system diagram



NOTE: IC34 System setup may vary from example shown.

START UP

Power is continuously supplied to the job computer. The universal terminal (UT) will give access to the job computer options and operation.

- A firm touch is required when selecting a screen icon.
- Settings are NOT automatically saved when selected. The ACCEPT KEY  must be selected to save the setting. Select the ESCAPE KEY  to escape without saving settings and return to the previous menu.
- The console needs to be cycled off and back on when changing or attaching equipment to the system.
- The menu structure on your display might vary from the one displayed in this user manual depending on the universal terminal being used.







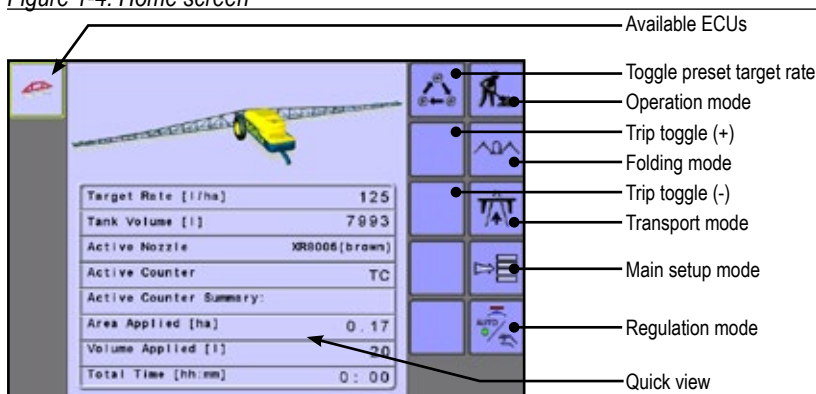

HOME SCREEN

 The Home screen gives access to the IC34's available functions. Power is continuously supplied to the job computer. The universal terminal will give access to the job computer options and operation.

NOTE: Information on the ECU will vary depending on the parameters set by the user and the OEM.

Figure 1-4: Home screen



Key/button	Description
Available ECUs (image varies depending on systems available)	Systems currently available on your UT are displayed in the left hand column of every page. To navigate between systems simply press the icon to open the desired system.
 Operation mode	Accesses the working aspects of the IC34 including boom section control, rate control and trip/count/application information.
 Folding mode	Controls boom folding options.
 Transport mode	Locks all spray and hydraulic functions to prevent accidents.
 Main setup mode	Menu to input various spray settings.
 Regulation mode	Switch between automatic or manual regulation modes. A green dot indicates the current selection.
 Toggle preset target rate	Toggle between established target application rates. <i>NOTE: Preset application rates can be entered in the Job parameters menu.</i> <i>SHORTCUT: While in Operation mode, press target rate on the touch screen to change preset target rates.</i>
 Trip toggle (+)	Use to select an increasing Active trip count number. <i>NOTE: Trip specific settings can be entered in the Job parameters menu.</i>
 Trip toggle (-)	Use to select a decreasing Active trip count number. <i>NOTE: Trip specific settings can be entered in the Job parameters menu.</i>
Quick View	Information displayed is based on the Current active trip

ISOBUS Job Computer: IC34 Sprayer

OPERATION MODE

Information on the Operation screen will vary depending on the parameters set by the user and the OEM.

Figure 1-5: Operation mode screen overview

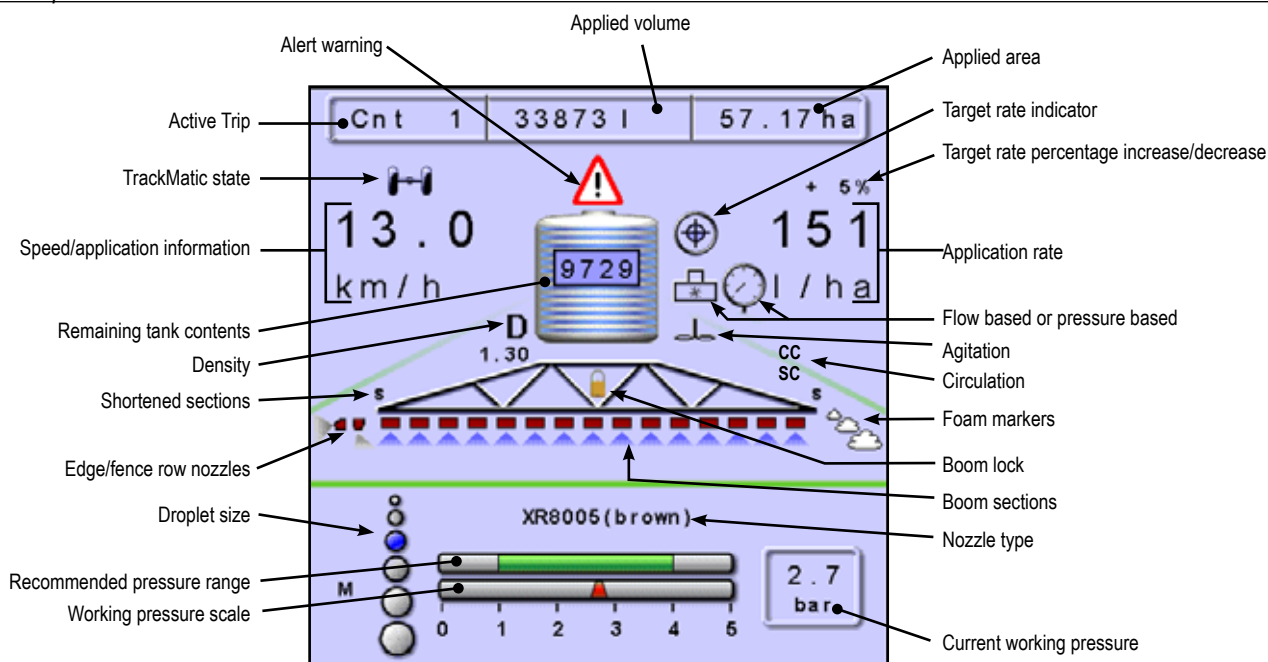

Figure 1-6: Automatic mode – soft key page one (1)

Figure 1-7: Automatic and manual mode – soft key page two (2)

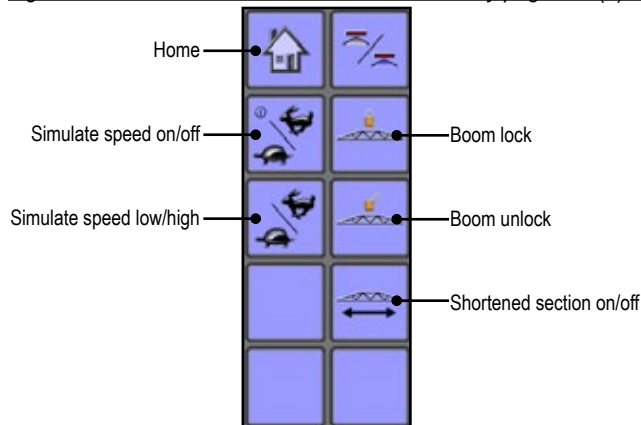
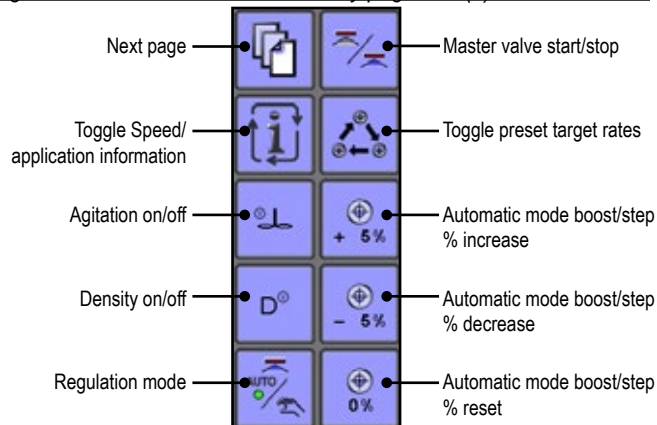
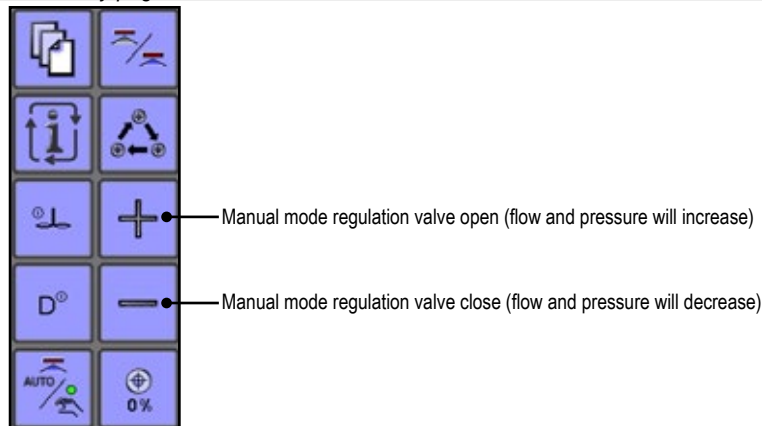

Figure 1-8: Manual mode – soft key page



MAIN SETUP SCREEN

The main setup menu contains six options. Each of these options either directly access settings or additional menus.

Figure 1-9: Main setup screen

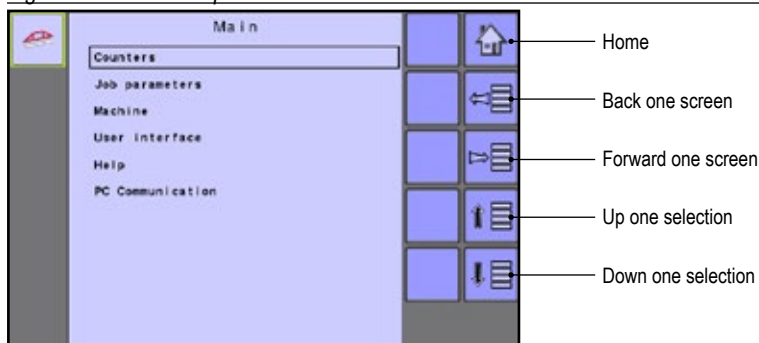

The table below outlines the additional menus and directs you to the setup pages for further information.

MENU STRUCTURE TABLE

Counters	Job parameters	Machine	User interface	Help	PC communication
▶ Trip		▶ Filling		▼ Diagnostic	
▶ Campaign		▶ Operation		▶ Test input	
▶ Total		▼ Implement parameters		▶ Test output	
▶ Export		▶ Section width		▶ PowerLink+	
		▶ Nozzle preset setup		▶ UT	
		▶ Regulation parameters		▶ TECU	
		▶ Shortened sections		▶ About	
		▼ Calibrations			
		▶ *Flow sensor			
		▶ *Liquid pressure sensor			
		▶ Implement speed sensor			
		▶ *Fill flow sensor			
		▶ *Tank level sensor			
		▶ *Wind speed sensor			
		▶ Alarm configuration			
		▼ OEM			
		▶ Sensor presence			
		▶ Implement parameters			
		▶ Implement geometry			
		▶ Valve setup			
		▶ Tank setup			
		▶ TrackMatic			
		▶ Regulation details			
		▶ Clear total counters			
		▶ Factory settings			
		▶ PowerLink+			
		▶ Use 3rd party UT			

The OEM setup menu is password protected and the settings in this menu are directly related to the fitted OEM equipment.

*Menu settings directly related to OEM equipment.

SETTING OPTIONS NAVIGATION

Figure 1-10: Enter selection screens

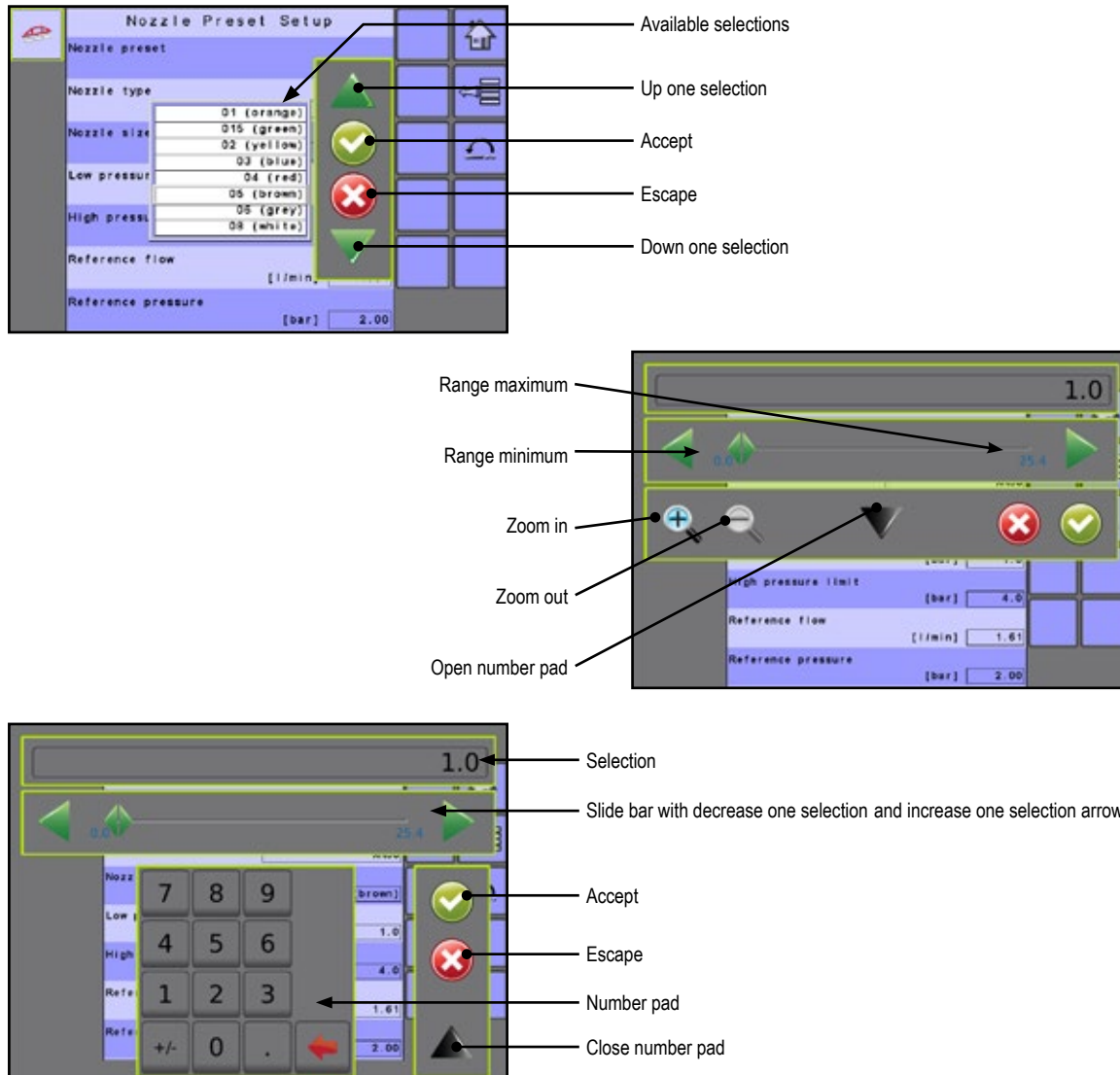

Section or icon	Description
Selection	Displays the current or new selection
Slide bar	Selects the setting by pressing and releasing on the slide bar or pressing and dragging the Slider to a designated value. Range for a specific setting is displayed on the slide bar.
Slider	Slide to the left to decrease or right to increase the selection
Increase one selection arrow	Increases the setting
Decrease one selection arrow	Decreases the setting
Number pad	Use the numbers to set the selection value
Open number pad	Maximizes the number pad

Section or icon	Description
Close number pad	Minimizes the number pad
Accept	Accepts the new selection
Escape	Escapes without saving changes
Up one selection arrow	Highlights the selection above
Down one selection arrow	Highlights the selection below
Zoom in	Narrows slide bar range. Grey = maximum zoom level.
Zoom out	Expands slide bar range. Grey = minimum zoom level.

CHAPTER 2 – OPERATION MODE



The Operation screen accesses the working aspects of the IC34 including boom section control, rate control and trip/count/application information.

NOTE: Settings are automatically saved when selected.

NOTE: The menu structure on your display might vary from the one displayed in this user manual depending on the virtual terminal being used.



AUTOMATIC OR MANUAL REGULATION MODE

There are two types of Regulation Mode - Automatic and Manual.

- On the Home Screen  or Operation Screen , establish Automatic Operation Mode or Manual Operation Mode by pressing the REGULATION MODE KEY  so that the green dot is on AUTO (automatic) or the hand (manual) accordingly.

Automatic Regulation Mode

The system will adjust the application rate based on the vehicle speed and active boom width in use for the current the target rate.

- The target rate can be adjusted using the BOOST/STEP % INCREASE/DECREASE KEYS   on the Operation Screen. Preset Application Rates define up to three (3) target rates for product being applied per hectare/acre. These can be toggled using the TOGGLE PRESET TARGET RATE KEY  on the Operation Screen or Home Screen.

Manual Regulation Mode



Retains an established regulation valve setting regardless of speed. The regulation valve setting can be adjusted using the REGULATION VALVE OPEN/CLOSE KEYS   on the Operation Screen.

Figure 2-1: Regulation mode on Home screen



Figure 2-2: Regulation mode on Operation screen

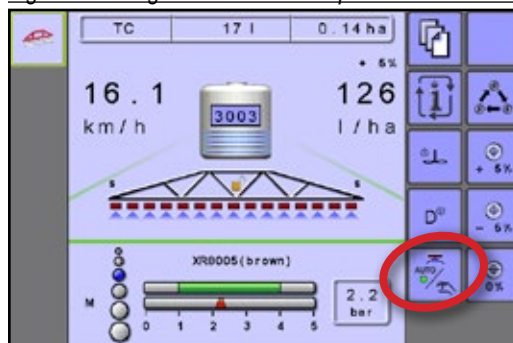

ISOBUS Job Computer: IC34 Sprayer

OPERATION MODE OVERVIEW

Information on the Operation screen will vary depending on the parameters set by the user and the OEM.

Figure 2-3: Operation mode screen overview

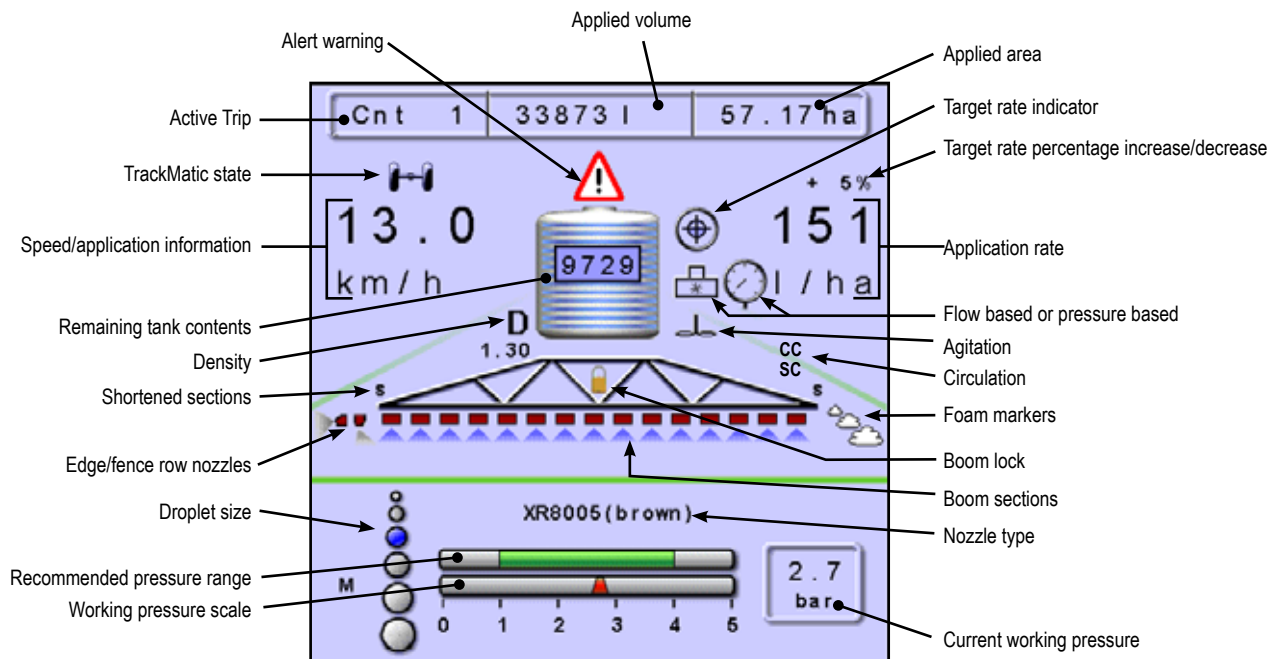

Figure 2-4: Automatic mode – soft key page one (1)

Figure 2-5: Automatic and manual mode – soft key page two (2)

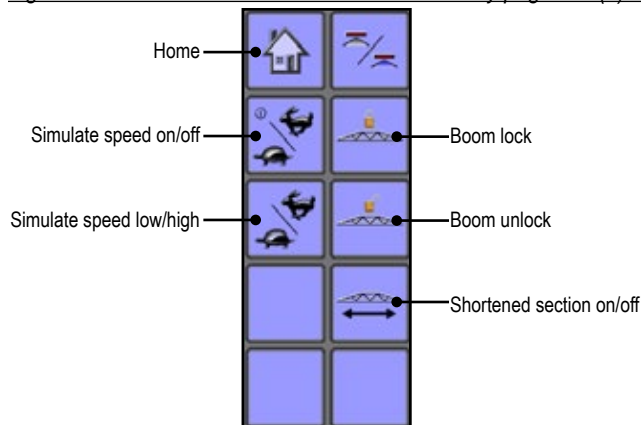
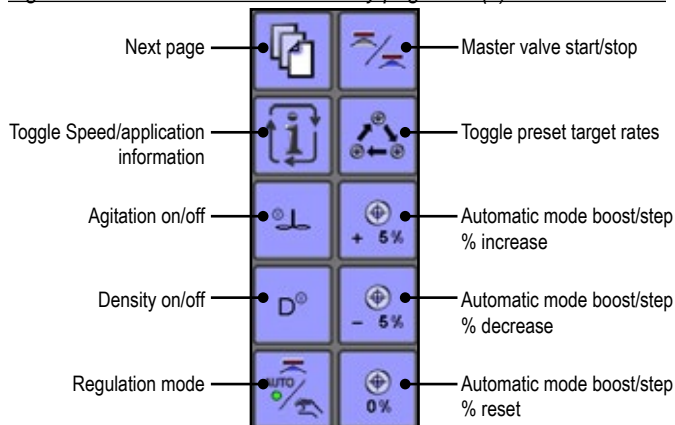

Figure 2-6: Manual mode – soft key page

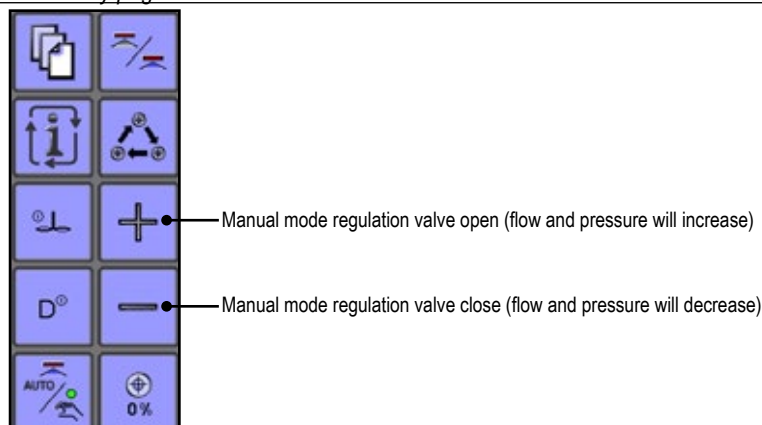









Table 2-1: Key/button Descriptions



Key/button	Description
	Next page Press to toggle between soft key options and pages. <i>NOTE: Some of the setting menus contain several pages.</i>
	Information Press to toggle between display modes.
	Agitation on/off Press to start or stop agitation.
	Density factor Press to initiate preset fertiliser density setting or return to water density. <i>SHORTCUT: Press the tank icon on the Operation screen to enter the density setting.</i>
	Regulation mode Press to toggle between automatic and manual regulation modes. A green dot indicates the current selection.











Automatic regulation mode automatically adjusts the application rate based on the current speed in reference to the target rate.

NOTE: Target rate boost/step percentage can be defined under Main -> Machine -> Operation -> Application Rate Step.

	Target rate boost/step percent increase	Establish the required boost percentage step, i.e. the step size, at which the application rate is to increase/decrease with the boost function.
	Target rate boost/step percent decrease	
	Target rate boost/step percent reset.	Reset the boost percentage step back to zero (0) percent.





























Manual Regulation Mode will retain an established regulation valve setting regardless of speed.





	Regulation valve manual open – opens the valve to increase pressure
	Regulation valve manual close – opens the valve to decrease pressure

	Master valve start/stop Press to start or stop application. Not available if a switch box is connected.
	Toggle preset target rates Press to toggle between established target application rates. <i>NOTE: Preset application rates can be entered in the Job parameters menu.</i> <i>SHORTCUT: Press the target rate on the Operation screen to change preset target rates.</i>
	Home Press to return to the Home screen
	Simulate speed on/off, low/high User can predefine two simulated speeds in operation menu
	Boom lock/unlock Soft keys to lock or unlock the boom
	Shortened section on/off Provides the operator the ability to turn off nozzles on the most left and most right section.
	Boom sections on/off Press to turn on sections to left  , turn off sections from left  , turn on sections to right  or turn off sections from right 

ISOBUS Job Computer: IC34 Sprayer

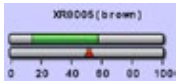
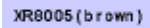
Table 2-2: Section/icon descriptions

Section/icon	Description	
Active trip information	This information bar displays the Active trip count number, Applied volume and Applied area.	
Active trip	Trip Mode – connected to an ISOBUS CAN with only a UT device found, the current active trip or job number will be displayed  . Task Controller (TC) Mode – connected on an ISOBUS CAN with a TC device found, then TC will be displayed  .	
Applied volume	Displays volume applied for the Active trip.	
Applied area	Displays applied area for the Active trip.	
Speed/application information	Displays vehicle speed, volume per minute, area left in tank, area per hour, time sprayed and actual working width. The INFORMATION KEY  toggles between display modes.	
Remaining tank contents	Displays the remaining tank content. <i>NOTE: If no tank sensor is fitted or the contents are not entered in the Tank filling menu prior to spraying, Tank contents may not display the correct amount.</i> <i>SHORTCUT: Press the Tank icon on the Operation Screen to enter the Tank filling menu.</i>	
Application rate	Displays the actual application rate per hectare/acre. <i>NOTE: When the Master is "on" the actual application rate per hectare/acre will be displayed. When the Master is "off" the target rate is displayed and the TARGET RATE ICON  appears.</i> <i>SHORTCUT: Press the actual rate on the Operation Screen to change the Application rate.</i>	
Target rate boost/step percentage increase/decrease	Displays Boost percentage step, i.e. the step size, at which the Application rate is to increase/decrease with the boost function.	
Alert warning	Displayed if an alarm condition is active.	
TrackMatic	Displays if a TrackMatic system is installed.	
Flow based/pressure based	These symbols will only appear if both a flow sensor and a pressure sensor are installed.	
	Flow Based – displayed if regulation is based on flow.	
	Pressure Based – displayed if regulation is based on pressure.	
Agitation	Displayed if an agitation valve is installed. Agitation ON  , Agitation OFF  .	
Circulation	If circulation is installed and selected in the OEM Menu, "SC" (Semi circulation) or "CC" (Full circulation) will be displayed.	
Density	Displays a "D" and the Density rate to the left of the Tank icon if the density is set to "Fertiliser" instead of water. <i>SHORTCUT: Press the Tank icon  for access to Density settings in the Tank filling menu.</i>	
Boom sections	Displays the active  and inactive  boom sections as well as if they are on  (spray is blue) or off  (spray is grey). <i>NOTE: The colour on the boom sections indicates the colour of the selected nozzle type.</i>	
Edge / fence row	Indicates an extra nozzle for Edge  or Fence  row spraying is installed on the machine.	
Shortened sections	Capability to turn off an amount of nozzles on the most left and most right sections. <i>NOTE: Applies to both left and right sections, it is not possible to work with a single shortened section.</i>	
Boom transport mode	An indication if the boom is locked or unlocked.	
Foam markers	Indicates foam markers are active.	

Section/icon	Description
Nozzle information	This information section displays the <i>nozzle</i> type, recommended pressure range, current working pressure and high pressure limit. 
Nozzle type	Displays the selected <i>nozzle</i> type. <i>SHORTCUT:</i> Press the current selected nozzle text on the Operation Screen to change nozzle type. 
Recommended pressure range	Displays the recommended pressure range for the selected nozzle (the green area indicates the pressure range). The pressure range will change depending upon the selected nozzle. IMPORTANT! ALWAYS REFER TO THE RECOMMENDED PRESSURE RANGE AS FAILURE TO DO SO MAY RESULT IN UNEVEN SPRAY PATTERNS. 
Working pressure scale	Displays the working pressure scale with current pressure indicator. <i>NOTE:</i> Working pressure should not exceed the recommended pressure range. IMPORTANT! ALWAYS REFER TO THE RECOMMENDED NOZZLE PRESSURE VALUES WHEN SETTING NOZZLE PRESSURE. 
Current working pressure	Displays the current working pressure. 
Droplet size	Indicates the actual droplet size based on the selected nozzle and the actual working pressure. 

APPLICATION RATE OPTIONS

Target rate

Preset application rates define up to three (3) target rates of product being applied per hectare/acre. These settings will set the same for all active trips. Target rates set to "0.0" will not be included in the toggle preset target rate options. These options can be toggled using the TOGGLE PRESET TARGET RATE KEY  on the Operation screen or Home screen.

SHORTCUT: Press the actual rate on the Operation Screen to change the application rate.

Figure 2-7: Target application rate in operation mode

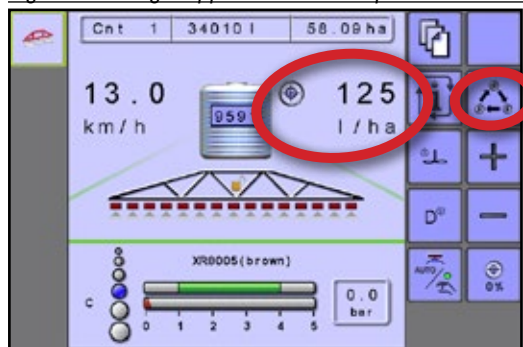
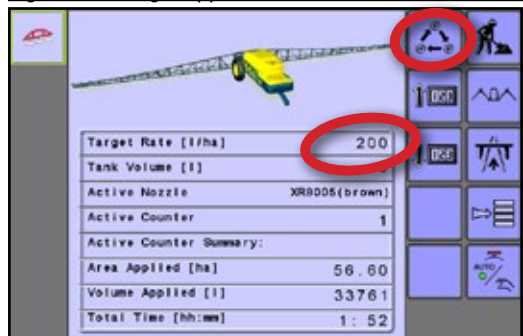

Figure 2-8: Target application rate on home screen



Target Rate/Step Percentage Increase/Decrease

The target rate percentage increase/decrease keys adjust the application target rate per the established percentage set in the Machine operation setup screen under Application rate step. Automatic regulation mode will automatically adjust the application rate based on the current speed in reference to the target rate.



- To adjust the Target Rate, press the BOOST/STEP % INCREASE/DECREASE KEYS   or RESET KEYS .

Figure 2-9: Target rate percentage increase/decrease



Regulation Valve Manual Open/Close

The regulation valve setting can be adjusted manually using the Regulation valve open/close keys on the Operation screen. Manual regulation mode will retain an established regulation valve setting regardless of speed.

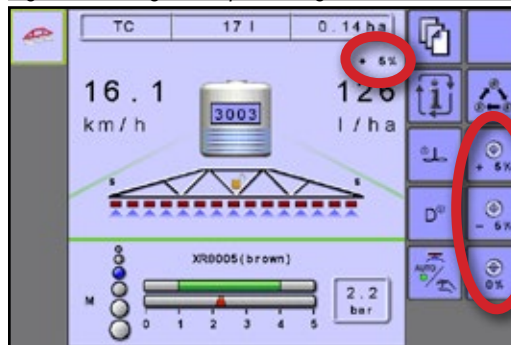

- To adjust the regulation valve setting, press the REGULATION VALVE OPEN/CLOSE KEYS  .

Figure 2-10: Manual regulation valve open/close



BOOM SECTIONS



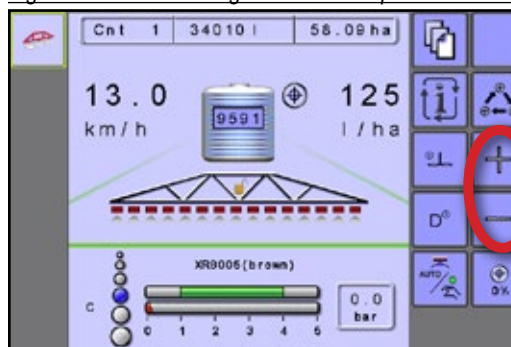

Boom sections represents the active  and inactive  boom sections as well as if they are on  (spray is blue) or off  (spray is grey).

Figure 2-11: Boom sections



The colour on the boom sections indicates the colour of the selected nozzle type.

Established Nozzle Capacities and Colours			
Size	Colour	Size	Colour
01	Orange	06	Grey
015	Green	08	White
02	Yellow	10	Light blue
025	Purple	12	Telemagenta
03	Blue	15	Light green
04	Red	20	Black
05	Brown	30	Beige

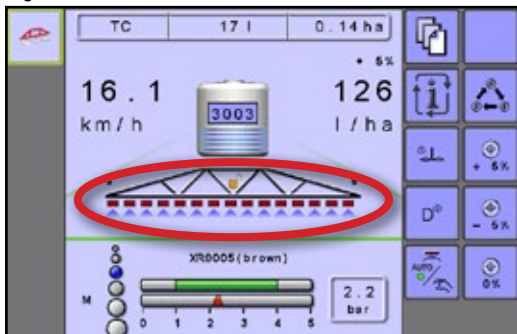
Start/stop application

Start/stop application is used to manage application by starting or stopping the application.

Without a switchbox

If a switchbox is not connected for boom section control, starting/stopping application is controlled by pressing the START/STOP KEY .

Figure 2-12: Application without a switchbox



With a switchbox

If a switchbox is connected for boom section control, starting/stopping application will be controlled by the switchbox.

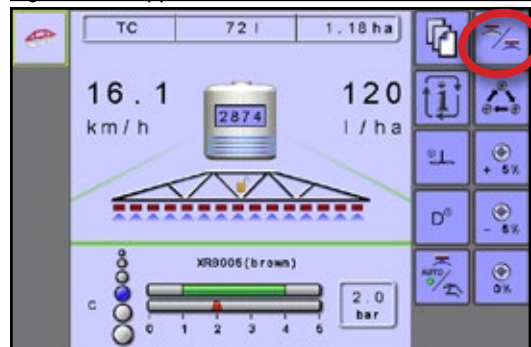
Figure 2-13: Application with a switchbox

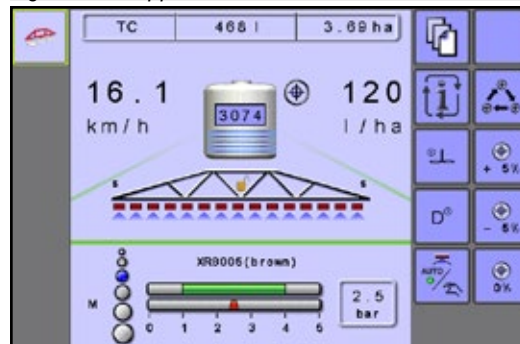

Boom sections on/off

Boom sections on/off is used to control boom sections from the left or right.

Without a switchbox

- To adjust the sections on the left, press the LEFT BOOM SECTIONS ON/OFF KEYS .
- To adjust the sections on the right, press the RIGHT BOOM SECTIONS ON/OFF KEYS .

Figure 2-14: Operations screen without switchbox

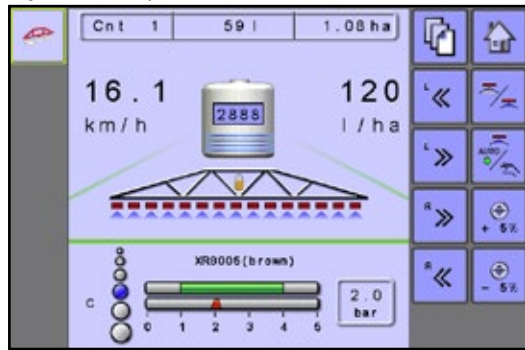
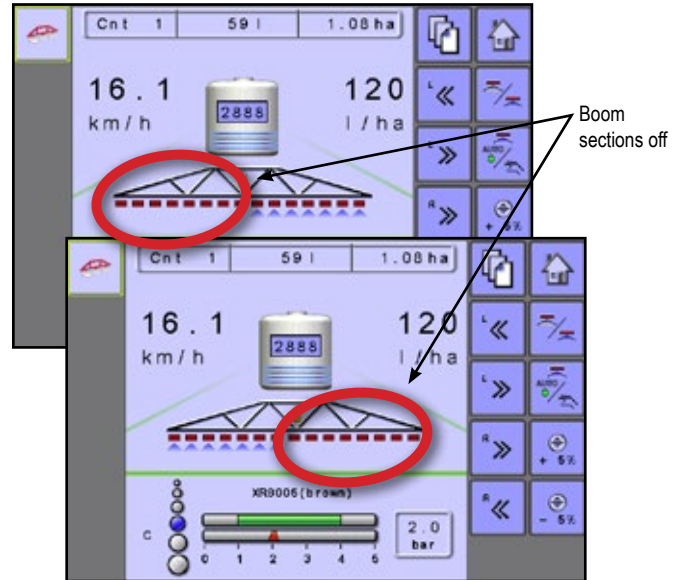

Figure 2-15: Boom sections



With a Switchbox

The console operates with nine (9), section switches. Each section switch is associated with one of up to the same number of sections on the boom and illustrated on the Operation screen. The console is capable of supporting up to 15 boom sections. The boom sections are paired across the nine (9) switches evenly but will work as individual sections in ASC mode.

NOTE: Although the Number of Sections range is up to 15, the max. number of physical switches are still nine (9).

Figure 2-16: Operations Screen with Switchbox

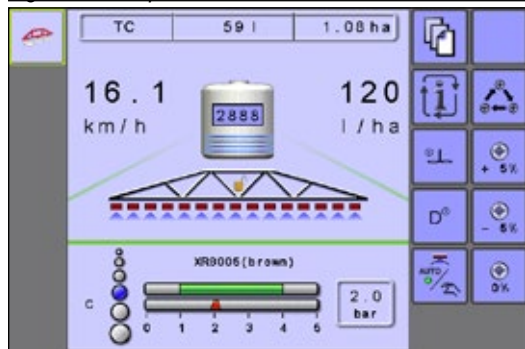

Table 2-1: Pairing Key for 9 physical section switches operating with 10, 11, 12, 13, 14 and 15 Boom Sections

Section Switches 1-9	Boom Section Pairing Greater Than 9 Boom Sections					
	10 Sections	11 Sections	12 Sections	13 Sections	14 Sections	15 Sections
1	1	1	1	1	1	1
2	2	2	2	2	2	2 and 3
3	3	3	3	3 and 4	3 and 4	4 and 5
4	4	4 and 5	4 and 5	5 and 6	5 and 6	6 and 7
5	5 and 6	6	6 and 7	7	7 and 8	8
6	7	7 and 8	8 and 9	8 and 9	9 and 10	9 and 10
7	8	9	10	10 and 11	11 and 12	11 and 12
8	9	10	11	12	13	13 and 14
9	10	11	12	13	14	15

INFORMATION

The INFORMATION KEY  toggles the Speed/application Information section on the Operation screen between the display modes.

Figure 2-17: Information



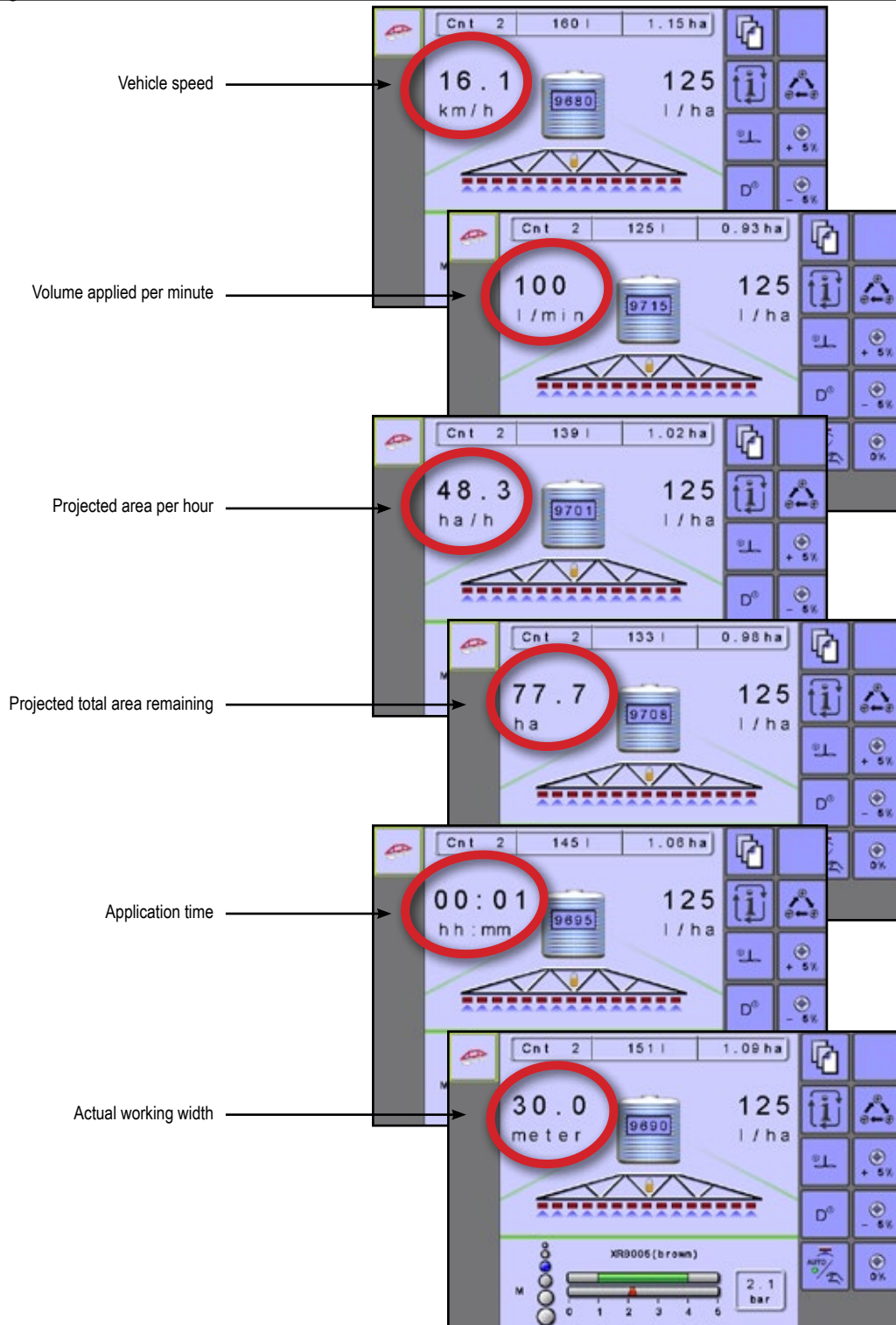

CHAPTER 3 – TRIP TOGGLE / TASK CONTROLLER

The sprayer ECU contains 16 internal Active trip count numbers or can be set to Task controller (TC) mode. Counters can be selected by pressing the Trip counter up/down keys.

TRIP MODE

One of up to 16 Active trip count numbers can be selected to view the desired trip information. The trip that is “active” is displayed/active on the Home screen and Operation screen.

Press the TRIP TOGGLE KEYS   to toggle through the up to 16 trip count settings.

Examples may differ as this is dependant on the sprayer configuration.

Figure 3-1: Home screen - trip toggle

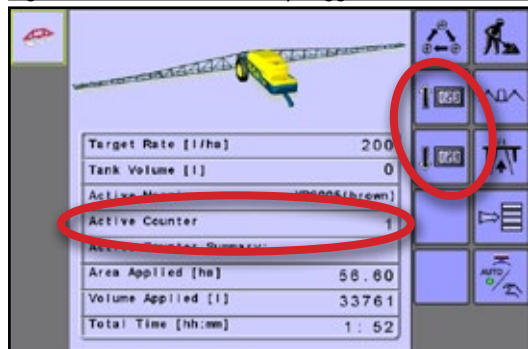
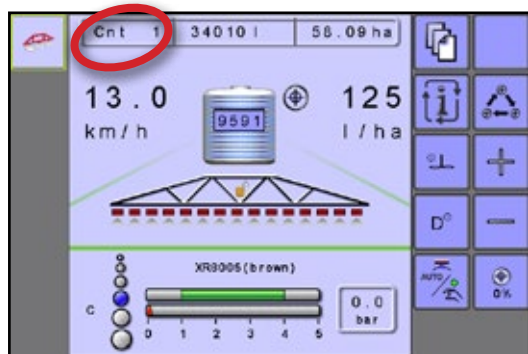

Figure 3-2: Active trip count number on Operation screen



TASK CONTROLLER MODE

When using information generated from a FMIS, the job parameters will be set to Task controller. Tasks will contain the types of information that should be logged as well as prescription maps and other information.

Figure 3-3: Home screen – in TC mode

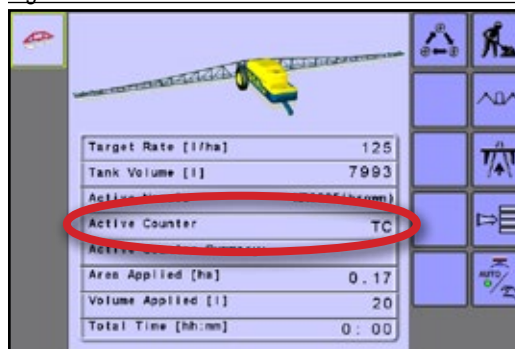

NOTE: While in Task controller (TC) mode, the internal counters will be disabled and the job toggle buttons will be hidden.

Figure 3-4: TC on Operation Screen

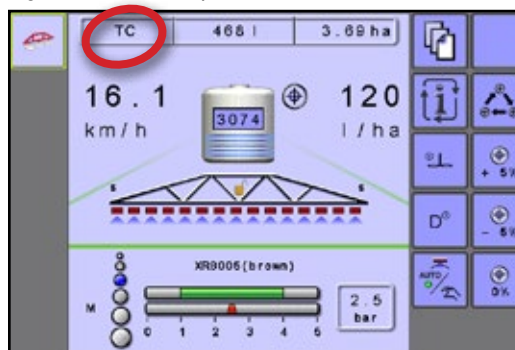

NOTE: If using a Task controller, the Active trip count number will display as “TC”.

Clear trip counter information

To clear information specific to an active trip count number, see Main setup-> Counter-> Trip counters.

NOTE: While in Task Controller (TC) mode, the internal counters will be disabled and the job toggle buttons will be hidden.

Clear task control counter information

To clear information specific to an active trip count number, see Main setup-> Counter-> Trip counters.

CHAPTER 4 – FOLDING

The folding menu will give access to hydraulic functions which isn't available on the ISOBUS switchbox.

Folding Mode can be accessed from the Home screen by pressing the FOLDING MODE KEY . The following examples may differ as this is dependent upon sprayer configuration. Due to the variety of possible configurations, this should be used for reference purposes only.

Figure 4-1: Folding mode on Home screen



With a switchbox

If a switchbox is being used to control the boom sections, folding will be controlled by the switchbox..

Figure 4-2: Folding mode with a switchbox



Without a switchbox

When folding without a switchbox, there are three (3) sets of options. The left and right sections are referred to as if facing in the machine's forward direction.

- Simultaneously - folding both the left and right sections at the same time; inner sections and 2nd sections can be folded separately
- Left sections - folding only the left sections; inner section and 2nd section can be folded separately
- Right sections - folding only the right sections; inner section and 2nd section can be folded separately

Press the TOGGLE FOLDING MODE KEY    to switch between folding mode options.

Figure 4-3: Folding mode without switchbox

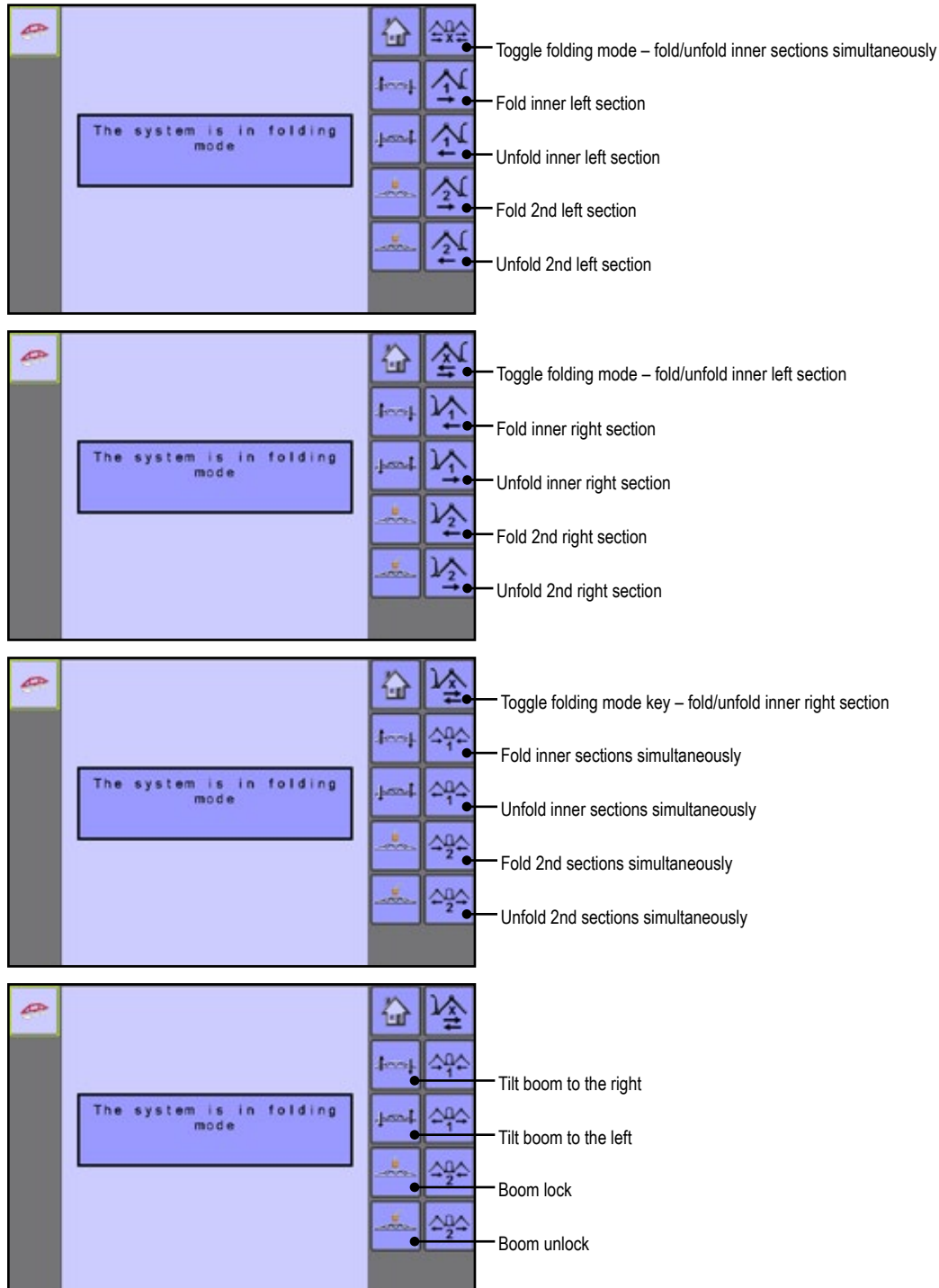

CHAPTER 5 – TRANSPORT

While in Transport mode, all operation functions are locked off and cannot be activated. Transport mode displays the speed in analogue mode.

Figure 5-1: Transport Mode from the Home Screen



Figure 5-2: Transport mode

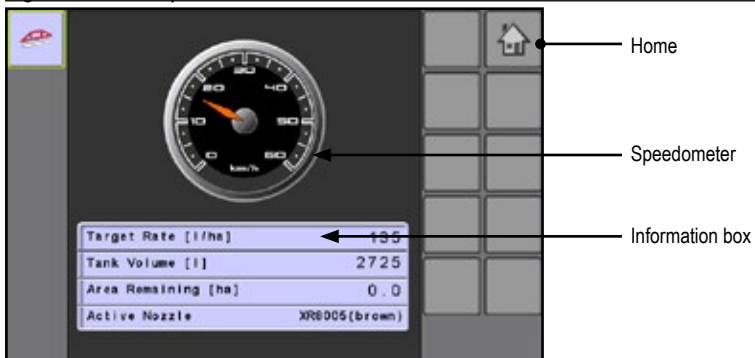

CHAPTER 6 – SETUP

The main setup menu is used to configure the console, manage the machine and its implements.

Main menu structure

MENU STRUCTURE TABLE

Counters	Job parameters	Machine	User interface	Help	PC communication
▶ Trip		▶ Filling		▼ Diagnostic	
▶ Campaign		▶ Operation		▶ Test input	
▶ Total		▼ Implement parameters		▶ Test output	
▶ Export		▶ Section width		▶ PowerLink+	
		▶ Nozzle preset setup		▶ UT	
		▶ Regulation parameters		▶ TECU	
		▶ Shortened sections		▶ About	
		▼ Calibrations			
		▶ *Flow sensor			
		▶ *Liquid pressure sensor			
		▶ Implement speed sensor			
		▶ *Fill flow sensor			
		▶ *Tank level sensor			
		▶ *Wind speed sensor			
		▶ Alarm configuration			
		▼ OEM			
		▶ Sensor presence			
		▶ Implement parameters			
		▶ Implement geometry			
		▶ Valve setup			
		▶ Tank setup			
		▶ TrackMatic			
		▶ Regulation details			
		▶ Clear total counters			
		▶ Factory settings			
		▶ PowerLink+			
		▶ Use 3rd party UT			

The OEM setup menu is password protected and the settings in this menu are directly related to the fitted OEM equipment.

**Menu settings directly related to OEM equipment.*

Main menu structure overview:

- ▶ Counters – access to various types of trip counters
- ▶ Job parameters – configure application settings
- ▼ Machine – configure vehicle parameters
 - ▶ Filling – establishes actual tank content, and material density.
 - ▶ Operation – establishes boost percentage step, speed source, and simulated speed low and high levels.
 - ▶ Implement parameters – establishes boom section width, nozzle preset setup, regulation parameters, and size of shortened sections.
 - ▶ Calibrations – establishes the flow sensor, liquid pressure sensor, implement speed sensor, tank level sensor, and tank fill flow sensor calibrations.
- ▶ Alarm configurations – configures system alarms for tank content minimum, agitation tank level alarm, flow/pressure cross check, and wind speed limit.
- ▶ OEM – Sprayer manufacturer’s basic settings.
- ▶ User interface – choose preferred UT and nozzle settings
- ▶ Help – perform diagnostics and view system information
- ▶ PC communication – establish a computer connection

Figure 6-1: Main Setup Screen



COUNTERS

The Counters Menu provides access to various system counters allowing the user to view, reset or export trip information.

MENU STRUCTURE TABLE						
Counters	Job parameters	Machine	User interface	Help	PC communication	
▶ Trip						
▶ Campaign						
▶ Total						
▶ Export						

Counters menu structure overview:

- ▶ Trip – used to display information regarding area, distance, time, and amount applied
- ▶ Campaign – used to display information regarding area, amount applied, time, and speed information for all trips made since last reset
- ▶ Total – used to display information regarding area, amount applied, time, and speed information for all activity
- ▶ Export counters – allows counter information to be exported in HTML or CSV format

Trip counters

Trip counters display information regarding area, distance, time, and amount applied. The active trip counter is displayed/active on the Home screen and Operation screen.

- To clear current trip counters, press the SINGLE RECYCLE BIN KEY to clear data from the active trip counter.
- To clear all trip counters, press the DOUBLE RECYCLE BIN KEY to clear data from all trip counters.

NOTE: Trip counters will not be active when using a task controller.

Figure 6-2: Counters menu



Figure 6-3: Trip counters menu in trip mode

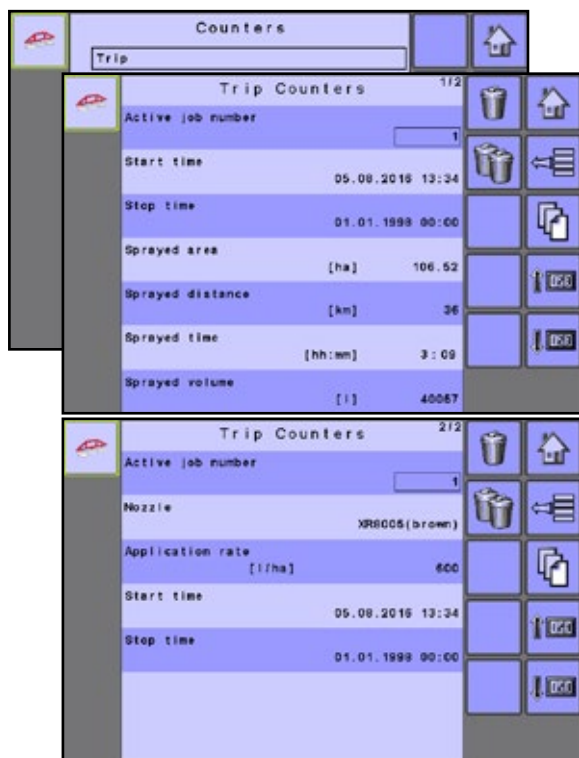

Figure 6-4: Trip counters menu in TC mode



Active job/trip number

One of up to 15 active Job/trip numbers can be selected to view the desired trip information. The trip that is "active" is displayed/active on the Home screen and Operation screen.

NOTE: If using a Task controller, the Active trip count will display as "0".

Start time

Displays a time stamp for when the Selected active trip count number began.

Stop time

Displays a time stamp for when the Selected active trip count number stopped.

Sprayed area

Displays the applied coverage area for the Selected active trip count number.

Sprayed distance

Displays distance travelled for the Selected active job.

Sprayed time

Displays time sprayed for the selected Active trip count number.

Sprayed volume

Displays volume of material applied during the Selected active trip count number.



Nozzle

Displays the nozzle selection for the Selected active trip count number.

Application rate

Displays the first Target application rate for the Selected active trip count number.

Trip toggle keys

Press the TRIP TOGGLE KEYS   to view up to 16 trip count number settings.

NOTE: Trip specific settings can be entered in the Job parameters menu.

NOTE: Trip toggle keys are only available in Trip mode.

Campaign counters

Campaign counters display information regarding area, amount applied, and time for all Active trip count numbers.

- To clear the current campaign counter, press the SINGLE RECYCLE BIN KEY  to clear data from all Active trip count numbers.

Figure 6-5: Campaign counters



Sprayed area

Displays total applied coverage area for all Active trip count numbers since last reset of Campaign counter.

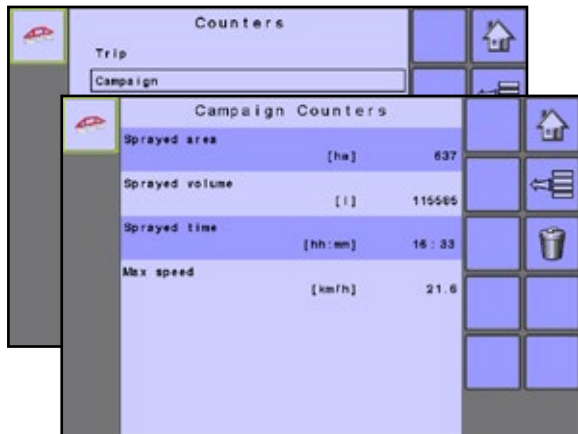
Sprayed volume

Displays total volume of material applied during all Active trip count numbers.

Sprayed time

Displays total time sprayed for all Active trip count numbers.

Maximum speed

Displays maximum speed recorded for all Active trip count numbers.

Total counters

Total counters displays information regarding area, amount applied, time, and maximum speed for all activity. Total counters can only be cleared in the OEM menu.

Figure 6-6: Total counters



Sprayed area

Displays total applied coverage area for all Active trip count numbers.

Sprayed volume

Displays total volume of material applied during all Active trip count numbers.

Sprayed time

Displays total time sprayed for all Active trip count numbers.

Maximum speed

Displays maximum speed recorded during work and transport for all Active trip count numbers.

Export counters

Export counters allows counter information to be exported in HTML or CSV format. HTML files can be viewed from an internet browser. CSV files can be viewed as Excel sheets. For data transfer, an optional cable is required. Contact your local dealer for additional information.



- To export a HTML file, select the HTML KEY . A confirmation screen will be displayed.
- To export a CSV file, select the CSV KEY . A confirmation screen will be displayed.

Figure 6-7: Export counters



JOB PARAMETERS

Job parameters configures application settings.

MENU STRUCTURE TABLE

Counters	Job parameters	Machine	User interface	Help	PC communication
----------	-----------------------	---------	----------------	------	------------------

Figure 6-8: Job parameters



Counter number

The current Active trip counter number is displayed at the top of the screen. While set as a task controller, the Active trip counter will display as a "0" in the Active trip counter number field. When acting as a stand alone, the Active trip counter will allow up to 16 active trip count numbers.

Preset application rates

Preset application rates define up to three (3) target rates of product being applied per hectare/acre. These settings will set the same for all active trips. Target rates set to "0.0" will not be included in the TOGGLE PRESET TARGET RATE  options on the Operation Screen or Home Screen.

Nozzle

Select one of five (5) preset nozzle types by pressing directly on the current nozzle information bar. Preset nozzle types are determined under the Machine menu then Implement parameters. This setting will set the same for all active trips.

Use shortened outer sections

Shortened sections are available for shortening the out-most left and right sections to a smaller working width than the physical size.

NOTE: Nozzles are required to be manually turned off.

Use circulation

If Circulation is installed and selected in the OEM menu, "SC" (Semi circulation) or "CC" (Full circulation) can be selected.

Figure 6-9: Job parameters - Use circulation

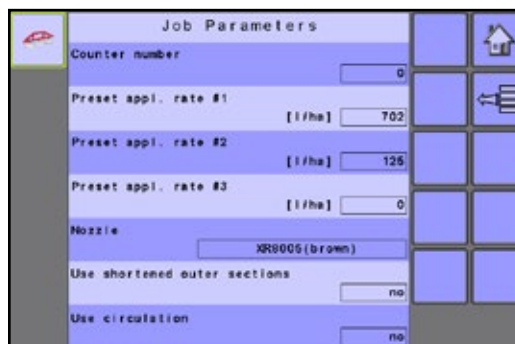

Idle pressure

When the Liquid pressure sensor is installed and selected in the OEM menu, Idle pressure establishes the pressure that will be retained when the vehicle is idle.

Figure 6-10: Job parameters - Idle pressure

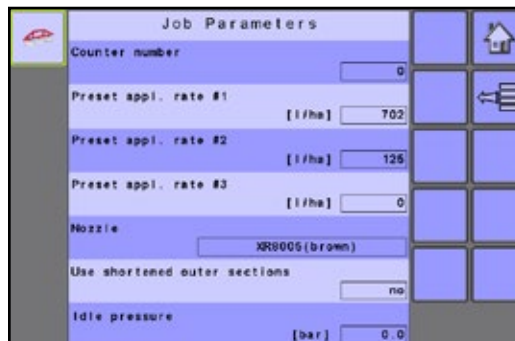

MACHINE

The Machine menu is used to configure vehicle parameters.

MENU STRUCTURE TABLE

Counters	Job parameters	Machine	User interface	Help	PC communication
		▶ Filling			
		▶ Operation			
		▼ Implement parameters			
		▶ Section width			
		▶ Nozzle preset setup			
		▶ Regulation parameters			
		▶ Shortened sections			
		▼ Calibrations			
		▶ *Flow sensor			
		▶ *Liquid pressure sensor			
		▶ Implement speed sensor			
		▶ *Fill flow sensor			
		▶ *Tank level sensor			
		▶ *Wind speed sensor			
		▶ Alarm configuration			
		▼ OEM			
		▶ Sensor presence			
		▶ Implement parameters			
		▶ Implement geometry			
		▶ Valve setup			
		▶ Tank setup			
		▶ TrackMatic			
		▶ Regulation details			
		▶ Clear total counters			
		▶ Factory settings			
		▶ PowerLink+			
		▶ Use 3rd party UT			

The OEM setup menu is password protected and the settings in this menu are directly related to the fitted OEM equipment.

*Menu settings directly related to OEM equipment.

Machine menu structure overview:

- ▶ Filling – establishes actual tank content and material density.
- ▶ Operation – establishes boost percentage step, speed source, simulated speed, and simulated speed low and high levels.
- ▶ Implement parameters – establishes boom section width, nozzle preset setup, regulation parameters, TrackMatic parameters and shortened sections.
- ▶ Calibrations – establishes the flow sensor, liquid pressure sensor, implement speed sensor, tank level sensor, fill flow sensor and wind speed sensor calibrations.
- ▶ Alarm configurations – configures system alarms for tank content minimum, agitation tank level alarm, flow/pressure cross check and wind speed limit.
- ▶ OEM – menu is password protected and the settings in this menu are directly related to the fitted OEM equipment.

Figure 6-11: Machine



Filling

Tank filling establishes the amount of material remaining in the tank and the density of that material. Different options will be available depending on if a tank sensor is installed.

NOTE: The size of the tank is established in the OEM menu. This is the number that will repopulate when the FULL TANK KEY  is pressed.

Figure 6-12: Filling



Desired content

Desired content establishes the desired maximum content volume. This option is available when tank sensor or fill flow sensor is active.

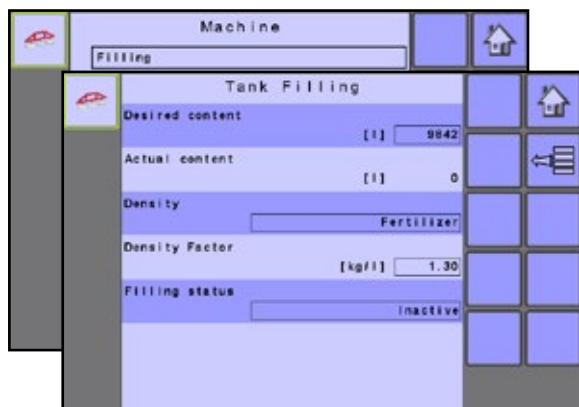
Actual content

Actual content displays the current volume of content in the tank. The volume can be manually adjusted.

NOTE: When a tank sensor is active, the actual content can not be changed manually.

Density

Density establishes the density of the material being applied. It can be set to either "Fertiliser" or "Water".

NOTE: If "Fertiliser" is selected, a density factor option appears.

Density factor

Density factor establishes the weight per volume setting based on the type of fertiliser being used. The fertiliser's ability to flow is affected by a number of factors. These factors may vary with each batch and it may change due to weather (humidity, etc.). In order to accommodate for this, the job computer uses a density factor to compensate for the nature of the applied fertiliser.

Full tank

Full tank returns the actual content volume value to the maximum volume of the tank.

Full tank - NOT AVAILABLE

The FULL TANK KEY  is not available when a tank sensor is activated.

Desired content

Desired content establishes the desired maximum content volume. This option is available when tank sensor or fill flow sensor is active.

Filling status

Filling status establishes if the tank is actively being filled. It can be set to either "inactive" or "active". This option is available when tank sensor or fill flow sensor is active.

Operation

Operation establishes boost percentage step, speed source, simulated speed and simulated speed low and high levels.

Figure 6-13: Operation

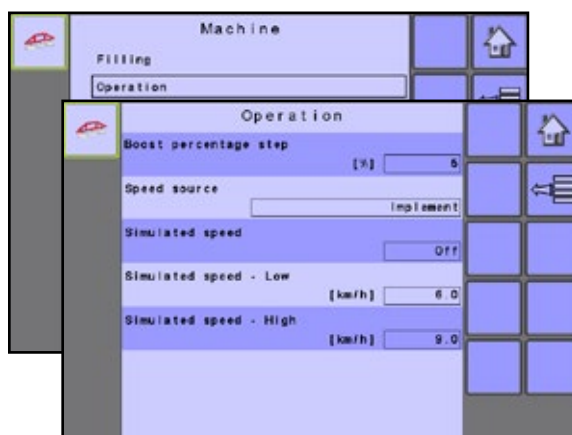

Boost percentage step

Application rate step is the percent of increase/decrease "boost" of the active application rate at which the product is being applied.

Speed source

Speed source selects whether to base the machine's speed on input from the CAN, an Implement or a Simulated source. Selecting "Implement" will allow for the configuration of impulses per 100 metres. Selecting "Simulated" will allow for simulated speed to be entered using the "Edit Value" option. Selecting "CAN" allows for speed being supplied by the ISOBUS CAN (usually from the TECU) to be used.

NOTE: If "Implement" is selected, refer to the Calibrations section for further instructions.

Simulated speed

Simulated speed establishes a low and high speed to be used when using the Simulated speed source.

Figure 6-14: Step % increase/decrease in Operation mode

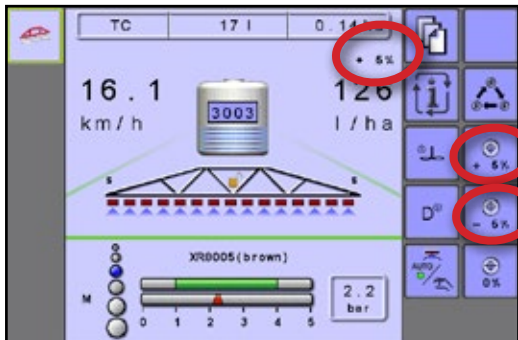

Implement parameters

Implement parameters establish the section width, nozzle preset setup, regulation parameters, and shortened sections.

Implement parameters Menu structure overview:

- ▶ Section width – sets the spraying width during application
- ▶ Nozzle preset setup – where up to five (5) sets of nozzle options can be established to set the nozzle type, size, low/high pressure limit, reference flow and reference pressure.
- ▶ Regulation parameters – where adjustments to the regulation valve action, nozzle spacing and regulations mode can be established.
- ▶ Shortened sections – provides the operator the ability to turn off nozzles on the most left and most right section

Figure 6-15: Implement parameters



Section width

The Section width menu is where the boom section widths are established. When the section widths change, power must be cycled in order to update the task controller on the UT.

NOTE: The number of boom sections available is set on the Implement parameters screen in the OEM section.

Figure 6-16: Section width

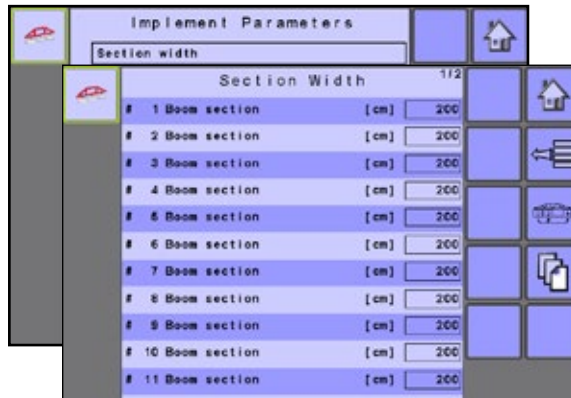

One-touch equal widths

The ONE-TOUCH EQUAL WIDTHS KEY  sets all boom section widths to the value set for the no.1 Boom Section.

Nozzle preset setup

Nozzle preset setup establishes up to five (5) presets of nozzle options including the nozzle type, size, low/high pressure limit, reference flow and reference pressure.

NOTE: When "General" nozzle type is selected and an established nozzle size is selected, the Low pressure limit, High pressure limit, Reference flow and Reference pressure fields will be automatically set with the standard settings for the specific nozzle chosen. These setting can be manually adjusted.

Figure 6-17: Nozzle preset setup



Nozzle preset

Each one of up to five (5) nozzle presets can be selected to establish different sets of nozzle options.

Nozzle type

A drop down menu where the user can choose a type of nozzle for the chosen preset.

Nozzle size

A drop down menu where the user can choose the size of nozzle for the chosen preset.

Established nozzle capacities and colours			
Size	Colour	Size	Colour
01	Orange	06	Grey
015	Green	08	White
02	Yellow	10	Light Blue
025	Purple	12	Telemagenta
03	Blue	15	Light Green
04	Red	20	Black
05	Brown	30	Beige

Figure 6-18: Nozzle size on the Operating screen

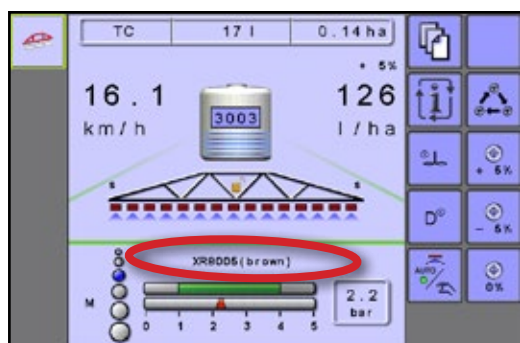

Low pressure limit

Establishes the limit for the lowest allowed operating pressure for the selected nozzle type.

High pressure limit

Establishes the limit for the highest allowed operating pressure for the selected nozzle type.

Reference flow

Establishes the value for the volume applied over a specific time (LPM).

Reference Pressure

Establishes the pressure value at which the application rate is true (ISO=2 bar).

IMPORTANT! Always refer to the nozzle pressure values recommended by the supplier when setting the nozzle pressure

Figure 6-19: Recommended pressure range bar and High pressure limit on the Operating screen

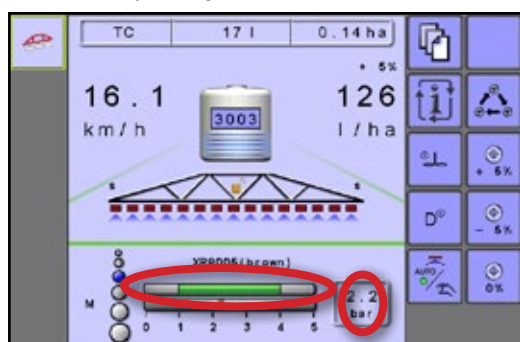

IMPORTANT! Always refer to the nozzle pressure values recommended by the supplier when setting the nozzle pressure.

Factory settings

Pressing the FACTORY RESET KEY  resets all nozzle settings to the default settings for the selected nozzle size and type.

Regulation parameters

Regulation parameters establishes adjustments to the regulation valve action, nozzle spacing and regulations mode.

Figure 6-20: Regulation parameters - Flow sensor only

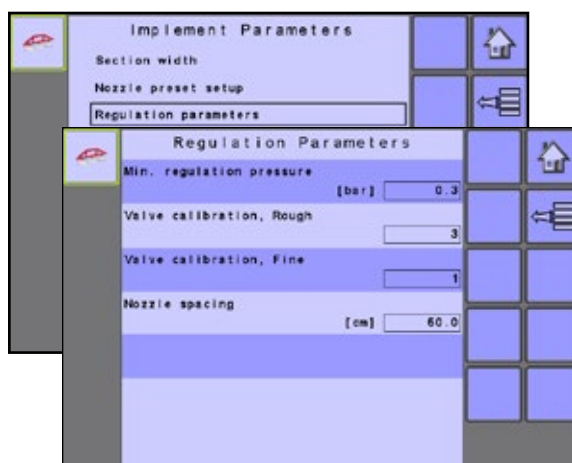

NOTE: Adjusting the Valve calibration settings involves significant changes and adjustments should therefore be made in small steps.

NOTE: The following setting values can be adjusted to optimize system performance. If you notice that the valve seems to “search” for the programmed application rate by cycling the pressure up and down continuously, reduce the number until the “searching” is minimized or eliminated. Conversely, a higher number will increase the valve response time and “speed up” the rate of adjustment.

Minimum regulation pressure

When running in auto rate mode, the rate controller will not regulate to a pressure lower than the inserted value.

Valve Calibration, Rough

Rough regulation value calibration allows you to regulate the setting of the regulating valve to accommodate different application needs. Operating conditions may necessitate a higher or lower response setting for the regulating valve. This value adjusts the setting for coarse adjustments in relation to a large percentage outside of the target application rate

- ▶ If the system is too slow in finding the correct rate, the values should be increased.
- ▶ If the system is too unstable, the values should be decreased.

If your system is plumbed in a bypass mode, the valve setting number of nine (9) works very well in most applications.

If your system is plumbed in a throttling mode, start with a valve setting number of three (3) and adjust the number according to your application requirements. Low flow situations will require a slower response time. Adjusting agitation volumes to accommodate the regulating valve to work in a more fully open position allows for a faster response time, with little to no searching.

Valve calibration, fine

Fine regulation value calibration allows you to regulate the setting of the regulating valve to accommodate different application needs. Operating conditions may necessitate a higher or lower response setting for the regulating valve. This digit adjusts the setting for the fine tune adjustment in relation to a small percentage close to the target application rate.

- ▶ If the system is too slow in finding the correct rate, the values should be increased.
- ▶ If the system is too unstable, the values should be decreased.

If your system is plumbed in a bypass mode, the valve setting number of five (5) works very well in most applications.

If your system is plumbed in a throttling mode, start with a valve setting number of three (3) and adjust the number according to your application requirements. Low flow situations will require a slower response time. Adjusting agitation volumes to accommodate the regulating valve to work in a more fully open position allows for a faster response time, with little to no searching.

Nozzle spacing

Nozzle spacing establishes the distance between the nozzles on the boom. The nozzle spacing must accommodate the sections size.

Regulation mode, stop reg at low flow limit

Depending on Sensor Presence settings (Flow Sensor / Liquid Pressure Sensor), this section may vary.

- ▶ Flow sensor is enabled: Stop reg at low flow limit - If "Yes" is selected, regulating will stop if the sprayed volume is less than the minimum flow stated in the flow metre calibration screen.

Figure 6-21: Regulation parameters - Flow sensor is enabled

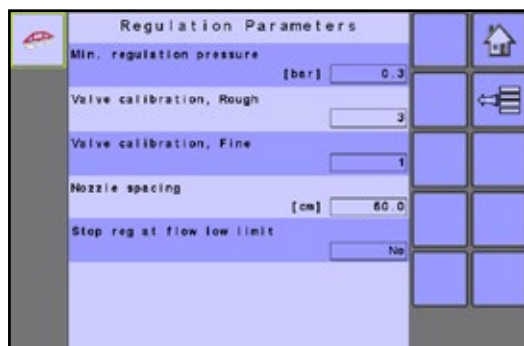

- ▶ Pressure sensor is enabled: Line will be empty, no setting available

Figure 6-22: Regulation parameters - Pressure sensor enabled

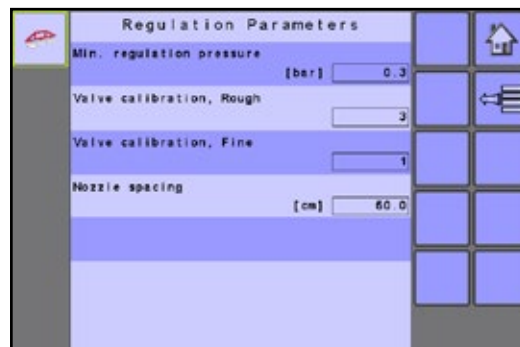

- ▶ Flow sensor and Pressure sensor are enabled: Regulation mode presents two options - Flow based and Pressure based. If set to Flow based it will use flow metre within the stated range of the flow metre. If exceeding the range of the flow metre it will automatically jump to pressure based regulation. If set to Pressure based it will only use pressure based regulation.

Figure 6-23: Regulation parameters - Flow sensor and Pressure sensor enabled

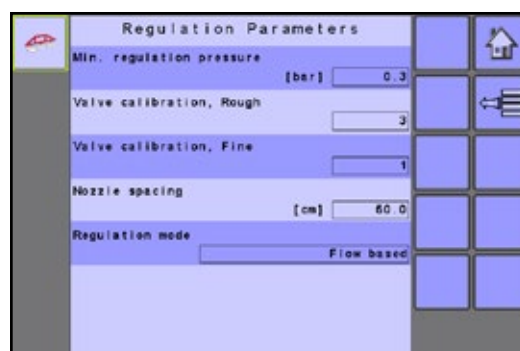

Shortened sections

Shortened sections provides the operator the ability to turn off nozzles on the most left and most right section.

NOTE: This setting applies to both sections. It is not possible to work with a single shortened section on left or right side.

Figure 6-24: Shortened sections

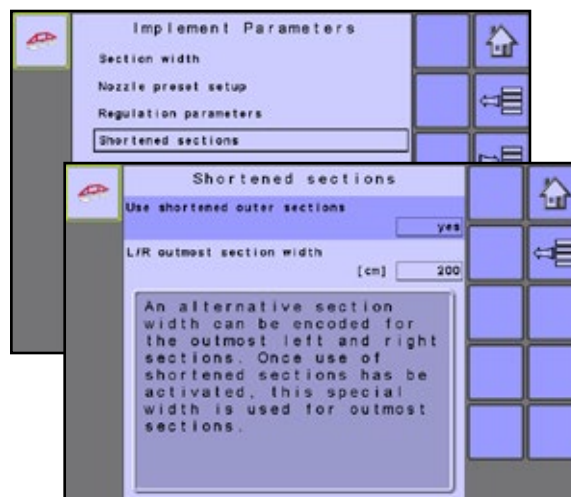

Use shortened outer sections

Choose “yes” or “no” to use shortened outer sections.

Left/right outmost section width

Determine the width of the left and right outmost sections, when shortened sections are set to “yes”.

Calibrations

Calibrations establishes either manual or automatic settings of the sensors.

Calibrations Menu Structure Overview:

- ▶ Flow Sensor – establishes the impulses per gallon/litre of fluid used when spraying
- ▶ Fill Flow Sensor – establishes the impulses per gallon/litre of fluid entering the tank while filling
- ▶ Liquid Pressure Sensor – establish the correct pressure reading
- ▶ Implement Speed Sensor – establishes wheel impulses over a specified distance
- ▶ Tank Level Sensor – establishes tank levels as well as calibrates the tank shape
- ▶ Wind Speed Sensor – establish the correct wind speed reading

Figure 6-25: Calibrations

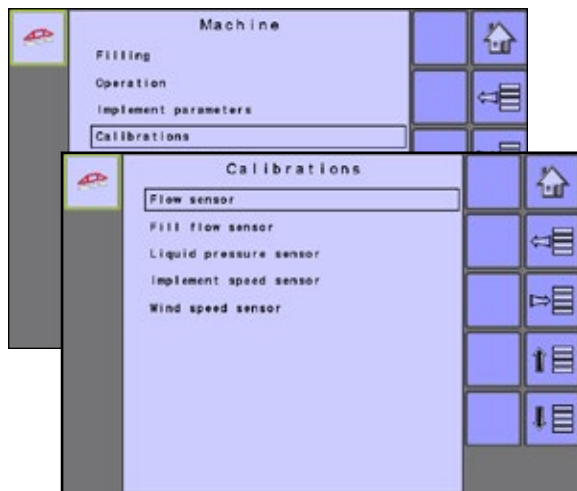

NOTE: For specific calibration options to appear, a specific sensor needs to be installed. Sensor availability is activated on the Sensor Presence screen in the OEM section.

Flow sensor

The Flow sensor establishes the impulses per litre, setting low and high limits. This value can be established manually or calibrated automatically.

Figure 6-26: Flow Sensor





Manual Calibration

Manual calibration establishes the calibration and limits based on user entered values.

- To calibrate the sensor, enter the following:
 - ▶ Flow meter calibration – sets the impulses per liter
 - ▶ Low limit – sets the low flow limit of the sensor
 - ▶ High limit – sets the high flow limit of the sensor

Automatic Calibration

If the number of pulses per gallon/liter for the flow meter is not known or to make sure the value is correct, automatic calibration establishes the calibration and limits.

- To calibrate the sensor, select CALIBRATION KEY .
- Follow the series of instructions displayed.
- The following will be updated automatically:
 - ▶ Flow meter calibration – sets the impulses per liter
 - ▶ Low limit – sets the low flow limit of the sensor
 - ▶ High limit – sets the high flow limit of the sensor
- Select the ACCEPT KEY  to complete the calibration or the ESCAPE KEY  to cancel.

An option to enter a collected volume is displayed if there is no calculated volume.

Fill flow sensor

The Fill flow sensor is used for measuring the volume of water and establishing impulses per gallon/litre going into the sprayers tank while filling.

Figure 6-27: Fill flow sensor manual calibration

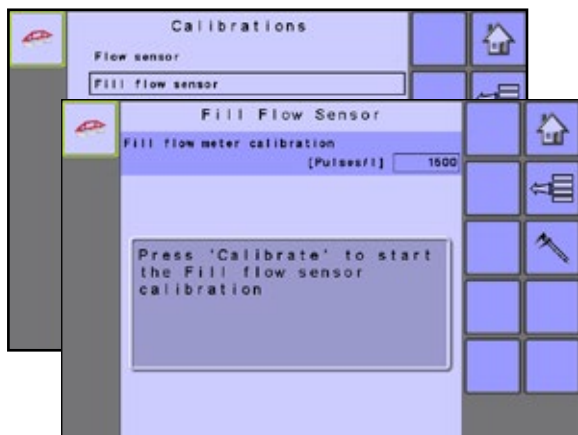



Manual Calibration

Manual calibration establishes the calibration and limits based on user entered values.

- To calibrate the sensor, enter the following:
 - Fill flow metre calibration – sets the impulses per liter

Automatic calibration

If the number of impulses per litre for the fill flow metre is not known or to make sure the value is correct, automatic calibration establishes the calibration and limits.

- To calibrate the fill flow sensor, select CALIBRATION KEY .
- Follow the series of instructions displayed.
- The following will be updated automatically:
 - Fill flow metre calibration – sets the impulses per liter
- Select the ACCEPT KEY  to complete the calibration or the ESCAPE KEY  to cancel.

The impulses counted will be displayed during the automatic calibration. An option to enter a collected volume is displayed if there is no calculated volume.

Liquid pressure sensor

The liquid pressure sensor will show the actual pressure of the liquid at the boom. The sensor should be calibrated at both the “No pressure” level and “Maximum pressure” level.

Calibrate each option in the following order:

- 1 Calibrate “No pressure”
- 2 Calibrate “Maximum pressure”

Figure 6-28: Liquid pressure sensor

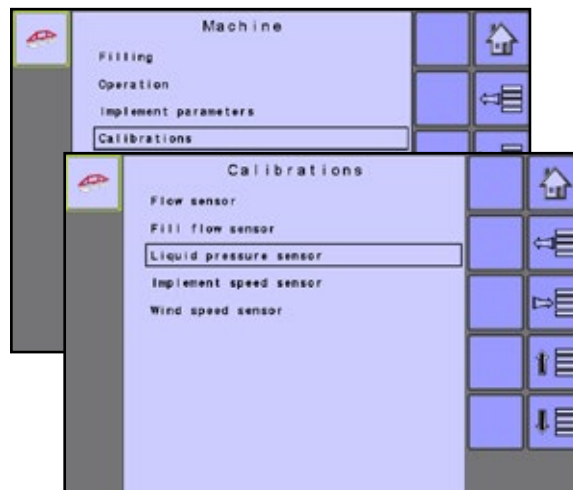

1 Calibrate “No pressure”

Calibrate “No pressure” establishes the calibration while no pressure is being applied to the liquid pressure sensor.

Figure 6-29: Calibrate “No pressure”

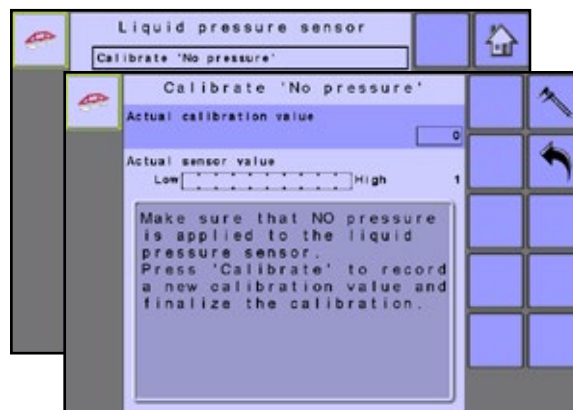

Manual calibration

Manual calibration establishes the value based on a user entered value.

- To calibrate the sensor, enter the following:
 - Actual calibration value – sets the value at which there is no pressure on the sensor

Automatic calibration

Automatic “No pressure” calibration establishes the value using the automatic calibration function.

- To calibrate the sensor, select CALIBRATION KEY .
- The following will be updated automatically:
 - ▶ Actual calibration value – automatically updates to the value at which there is no pressure on the sensor

Calibrate “Maximum pressure”

Calibrate “Maximum pressure” calculates the maximum pressure level of the attached pressure sensor. This calculation is based on the recommended maximum pressure level and a tested reference pressure level.







NOTE: Manual Calibration is not available.

Figure 6-30: Calibrate “Max pressure”



Automatic calibration

Automatic “Maximum pressure” calibration establishes the value at which the pressure level on the actual pressure sensor and the reference liquid pressure are equal.

- Establish maximum liquid pressure – determined by the type of pressure sensor used and should be set to the recommendations included with the pressure sensor.
- Establish reference liquid pressure – the pressure level you will want to reach on the actual pressure sensor when running the calibration process. The reference pressure cannot be changed while calibration is in progress.
- To calibrate the sensor, select CALIBRATION KEY .
- Start the application, press the START/STOP KEY .
- Adjust the regulation valve using the REGULATION VALVE OPEN/CLOSE KEYS   so that the pressure level on the actual pressure sensor and the reference liquid pressure are equal.
- The following will be updated automatically:
 - ▶ Actual calibration value – automatically updates to the value of the maximum pressure on the sensor
- Select the ACCEPT KEY  to complete the calibration or the ESCAPE KEY  to cancel.

Review the Help screen  for more information.

Figure 6-31: Liquid pressure sensor calibration

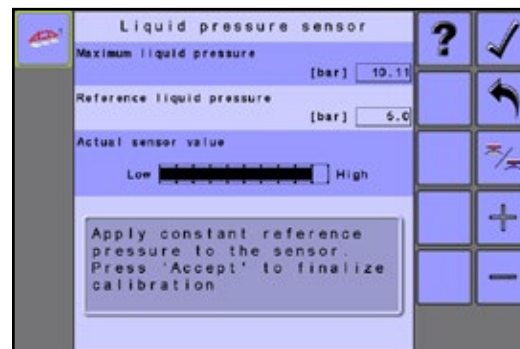

Implement speed sensor

The Implement speed sensor establishes the wheel impulses over a specified distance. This value can be established manually or calibrated automatically.

Figure 6-32: Implement speed sensor





Manual Calibration

Manual calibration establishes the pulses based on a user entered value.

- To calibrate the sensor, enter the following:
 - ▶ Impulses per distance – sets the pulses per 100 m.

Automatic calibration

Automatic calibration establishes the impulses using the automatic calibration function.

- To calibrate the sensor, select CALIBRATION KEY .
- Follow the series of instructions displayed.
- The following will be updated automatically:
 - ▶ Impulses per distance – sets the pulses per 100 m.
- Select the ACCEPT KEY  to complete the calibration or the ESCAPE KEY  to cancel.

The counted wheel impulses will be displayed during the automatic calibration.

Tank level sensor

Tank Level Sensor establishes the empty, minimum and maximum levels for the tank as well as calibrates the tank shape.

Calibrate each option in the following order:

- ❶ Calibrate "Empty"
- ❷ Calibrate "Minimum Level"
- ❸ Calibrate "Maximum Level"
- ❹ Calibrate "Tank Shape"

Figure 6-33: Tank level sensor

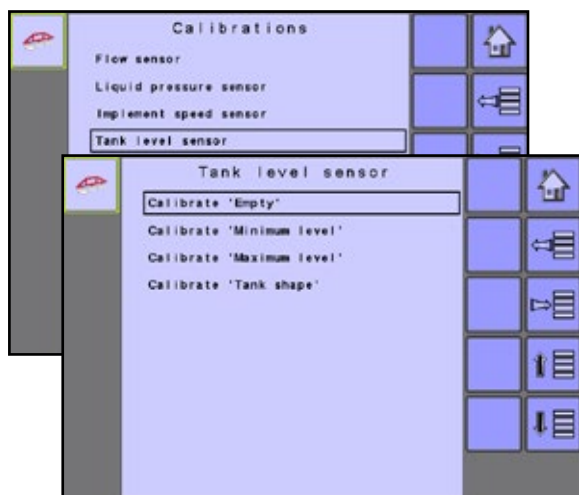

❶ Calibrate "Empty"

Calibrate "Empty" establishes the empty tank value.

IMPORTANT: The tank should be completely empty.

Figure 6-34: Empty tank

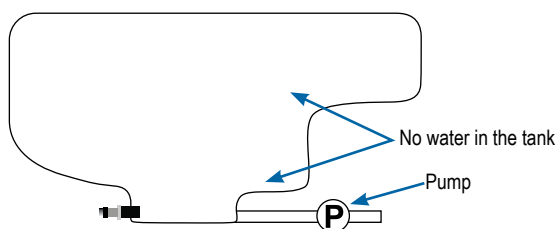



Figure 6-35: Calibrate empty



Automatic calibration

If the calibration value for the empty level is not known or to make sure the value is correct, automatic calibration establishes the calibration and limits.

- To calibrate the sensor, select CALIBRATION KEY .
- The following will be updated automatically:
 - ▶ Actual sensor value – sets the pressure on the sensor at which the tank is considered empty.

Manual calibration

Manual calibration establishes the calibration based on a user entered value.

NOTE: Manual establishment of an actual calibration value will override the automatically calibrated actual sensor value.

- To calibrate the sensor, enter the following:
 - ▶ Actual calibration value – sets the pressure on the sensor at which the tank is considered empty.

❷ Calibrate "Minimum level"

Calibrate "Minimum level" establishes the minimum level of water on the tank sensor.

- ▶ Tank minimum level – the level to which the tank should be filled and will be referenced to calibrate the sensor. Be sure the tank is filled with the contents displayed on the screen. The amount shown is established in Machine-> OEM-> Tank setup-> Minimum content.

Figure 6-36: Minimum tank level

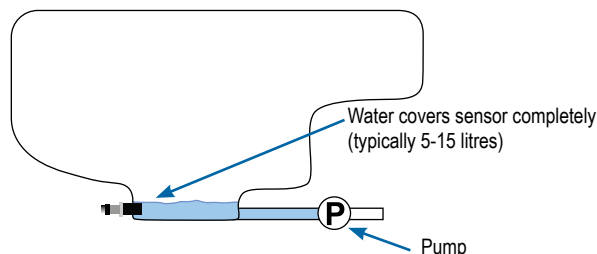



Figure 6-37: Calibrate minimum level



Automatic calibration

If the calibration value for the minimum level is not known or to make sure the value is correct, automatic calibration establishes the calibration and limits.

- To calibrate the sensor, select CALIBRATION KEY .
- The following will be updated automatically:
 - ▶ Actual sensor value – sets the pressure on the sensor at which the tank is considered at the referenced Tank minimum level.

Manual calibration

Manual calibration establishes the calibration based on a user entered value.

NOTE: Manual establishment of an actual calibration value will override the automatically calibrated actual sensor value.

- To calibrate the sensor, enter the following:
 - ▶ Actual calibration value – sets the pressure on the sensor at which the tank is considered at the referenced Tank minimum level.

Calibrate “Maximum level”

Calibrate “Maximum level” establishes the maximum level of water on the tank sensor.

- ▶ Tank maximum level – the level to which the tank should be filled and will be referenced to calibrate the sensor. Be sure the tank is filled with the contents displayed on the screen. The amount shown is established in Machine-> OEM-> Tank setup-> Maximum content.

Figure 6-38: Maximum tank level

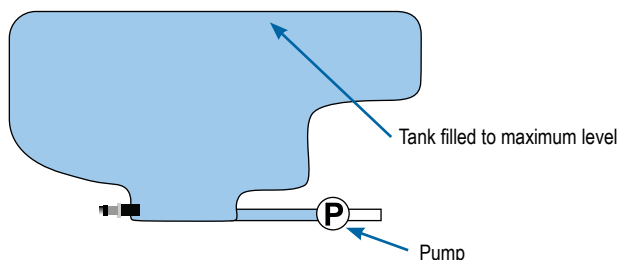

Figure 6-39: Calibrate maximum level



Calibrate “Tank shape”

NOTE: Manual Calibration is not available for Tank Shape calibration.

- ▶ Tank Maximum Level – the level to which the tank should be filled and will be referenced to calibrate the sensor. Be sure the tank is filled with the contents displayed on the screen. The amount shown is established in Machine-> OEM-> Tank Setup-> Maximum Content.

Figure 6-40: Tank shape calibration

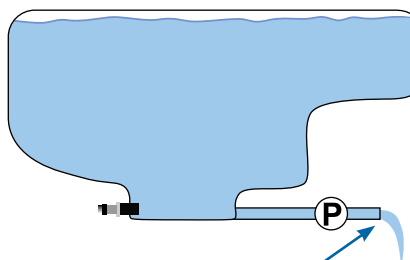



Pump water at same rate to empty tank in 30-60 minutes

Figure 6-41: Calibrate “Tank shape”



Automatic Calibration

- To calibrate the sensor, select CALIBRATION KEY .
- Follow the series of instructions displayed.
- The following will be updated automatically:
 - ▶ Actual tank sensor value – records the pressure on the sensor as the tank is emptied at a steady rate.
- Select the ACCEPT KEY  to complete the calibration



Accumulated volume output

Sprayed volume counted by the flow metre during tank shape calibration. The value can be used as “Tank maximum level” value.

NOTE: Value will not be transferred automatically to the tank settings. Value is just to serve as a cross check.

NOTE: The flow metre must be carefully calibrated before doing tank shape calibration.

Import/export “Tank shape”

Use the IMPORT KEY , or EXPORT KEY  to manage saved tank shape information.

Wind speed sensor

Wind speed sensor establishes the correct wind speed reading. This value can only be established manually.

Figure 6-42: Wind speed sensor

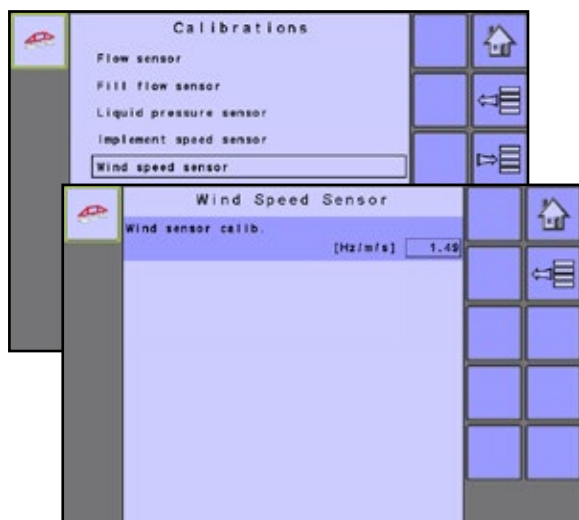

Manual calibration

Manual calibration establishes the pulses based on a user entered value.

- To calibrate the sensor, enter the following:
 - ▶ Wind sensor calibration – sets the Hertz per feet/meter per second.

Alarm configurations

Alarm configurations establishes alarms on or off as well as sets their trigger level.

Figure 6-43: Alarm configurations

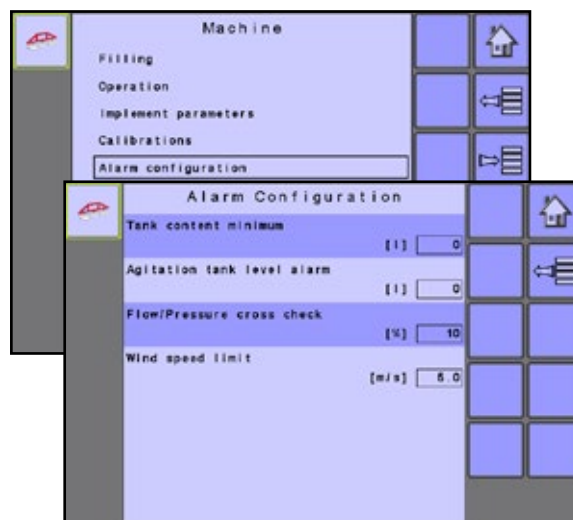

Tank content minimum

Tank content minimum establishes the minimum volume level at which an alarm will sound. Without a Tank sensor, the minimum is determined by calculating the difference between the established actual tank content volume and the calculated applied content volume. With a Tank sensor, the minimum is directly related to the sensor reading.

Agitation tank level alarm

Agitation tank level alarm establishes the minimum volume level at which an alarm will sound when agitation is active.

Flow/pressure cross check

Flow/pressure cross check establishes at what percentage the associated alarm will sound.

To deactivate this alarm, set the flow/pressure cross check percentage to zero (0).

Wind speed limit

Setting the Wind speed limit alarm will establish a threshold of operation in high wind situations.

OEM

The OEM setup menu is password protected and the settings in this menu are directly related to the fitted OEM equipment. Contact the manufacturer or local dealer for service.

The OEM setup menu is password protected and the settings in this menu are directly related to the fitted OEM equipment. Contact the manufacturer or local dealer for service.

NOTE: Some setup options are available or unavailable depending on the OEM settings. See the “Settings menu options table” for more information.

OEM menu structure overview:

- ▶ Sensor presence – used to establish sensors for flow, liquid pressure, fill flow and the tank
- ▶ Implement parameters – used to establish the sprayer mode, number of sections and circulation
- ▶ Implement geometry – used to establish if the implement is hitch mounted or trailed to predict the angle between the tractor and the boom when turning or driving in curves in the field.
- ▶ Valve setup – used to establish the regulation valve type, section valve behaviour and section valve type
- ▶ Tank Setup – used to establish maximum and minimum tank content, auto filling mode and auto filling offset value
- ▶ TrackMatic – used to configure and calibrate specific features when a TrackMatic system is installed
- ▶ Regulation Details – used to adjust the control of the regulation valve
- ▶ Clear Total Counters – used to reset all total counters including area, volume and time to the default settings
- ▶ Factory Settings – ability to import implement and user settings from a configuration file, or export to generate a configuration file based on the current implement and user settings.
- ▶ PowerLink+ – provides information on TankMatic and output modules, as well as the ability to turn them on or off and manage allocations
- ▶ Use 3rd Party UT – ability to connect to the use of a 3rd party UT's This feature is locked by the OEM. If locked, the ECU will only work with TeeJet ISOBUS UT's. If unlocked, the ECU will work with any ISOBUS UT.

Figure 6-44: Machine to OEM

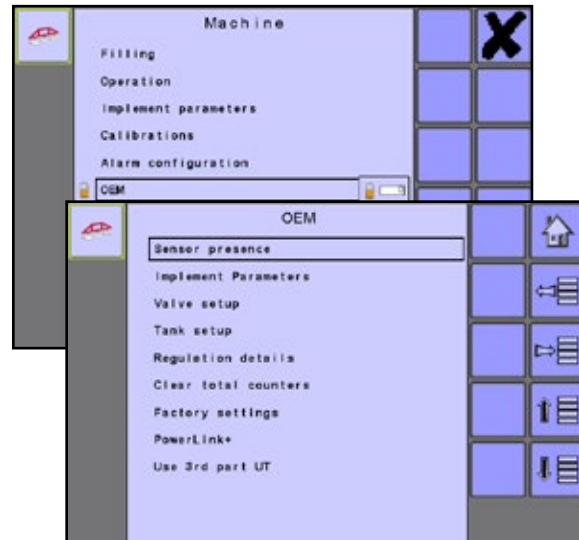

USER INTERFACE

User interface allows the operator to select the system nozzle settings and universal terminal (UT).

MENU STRUCTURE TABLE

Counters	Job parameters	Machine	User interface	Help	PC communication
----------	----------------	---------	----------------	------	------------------

Figure 6-45: User interface

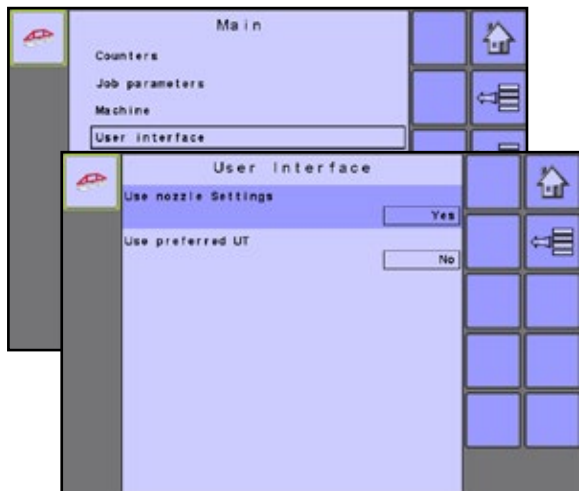

Use nozzle settings

Use nozzle settings sets the nozzle settings preference to either “Yes” or “No.”

- If set to “Yes” the nozzle ISO nozzles presets will be available as well as the droplet size monitor.
- If set to “No” the Operation Screen will show target rate and actual rate instead of droplet size, pressure range and actual pressure.

Use preferred UT

Use preferred UT sets the universal terminal (UT) preference.

If more than one UT is available on the ISOBUS CAN,

- Select “Yes” to use the current UT.
- Select “No” to use a different UT on the ISOBUS CAN. If all UTs are set to “No”, the system will arbitrarily select which UT to use.

If only one UT is available,

- Select “No”

NOTE: This should always be set to “No” unless another UT is on the CAN bus.

HELP

The Help menu allows the operator to perform diagnostic tests and view system information.

MENU STRUCTURE TABLE

Counters	Job parameters	Machine	User interface	Help	PC communication
				<ul style="list-style-type: none"> ▼ Diagnostic <ul style="list-style-type: none"> ▶ Test input ▶ Test output ▶ PowerLink+ ▶ UT ▶ TECU ▶ About 	

Diagnostic

Diagnostic is used to troubleshoot input/output of the controller

Diagnostic menu structure overview:

- ▶ Test input – displays the input high and low values on the installed sensors
- ▶ Test output – sets liquid valve values
- ▶ PowerLink+ – provides status on the connected output modules
- ▶ UT data – provides data information on the controller
- ▶ TECU – tractor control unit

Figure 6-46: Diagnostic

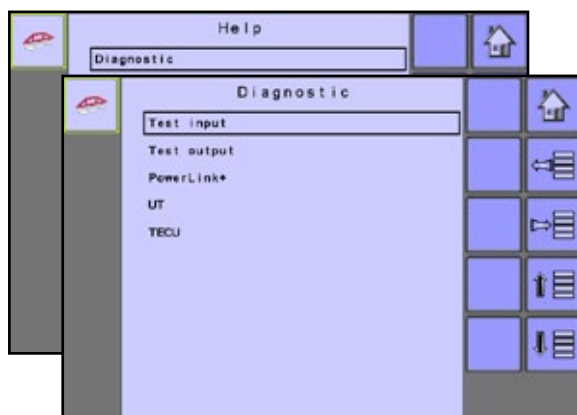

Test input

Test input displays the input high and low values on the installed sensors.

- To clear test input data, press the RECYCLE BIN KEY .

Figure 6-47: Test input



Test output

Test output sets the Liquid valve PWM dutycycle percentage as well as if Liquid master valve, and Liquid valve direction are on or off.

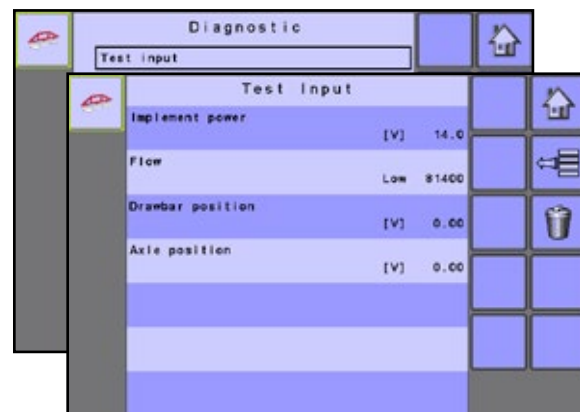
Liquid master valve

Master valve is used to test if the master valve is operating correctly. If you change the setting to “on”, the valve will open, change it to “off” and the valve will close.

Liquid valve PWM dutycycle

Liquid Valve PWM Dutycycle is used to test the regulating valve at different percentages of dutycycle.

Liquid valve direction

Liquid valve direction is used to verify if the operation of the Liquid valve direction is correct to a specific dutycycle.

Figure 6-48: Test output



PowerLink+

Test the connected output modules and show a status for the individual modules

Figure 6-49: PowerLink+



UT

The universal terminal (UT) menu provides UT data information regarding the virtual terminal controller (i.e., address version, etc.).

- GO TO NEXT UT KEY toggle between terminals/controllers.
- DELETE OBJECT POOL KEY to delete saved information on the UT. This forces the UT to upload all information from the IC34 on the next power cycle.

Figure 6-50: UT data

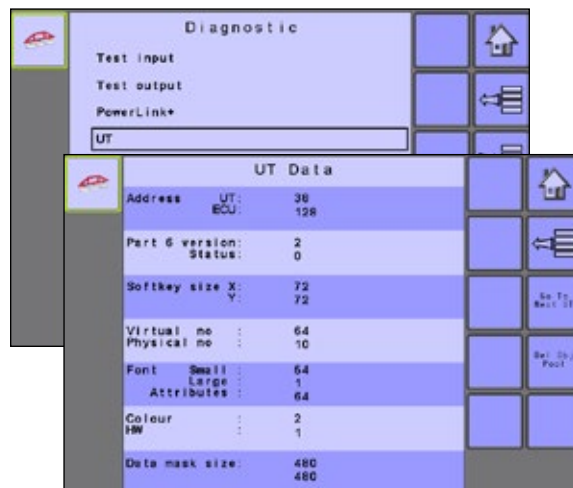

NOTE: Reconnect the IC34 job computer to implement and display changes.

TECU

The TECU is a control unit, residing on the tractor, that performs basic functions such as power handling, speed info, etc. TECU data is an informational screen showing the vehicle information.

Figure 6-51: TECU data

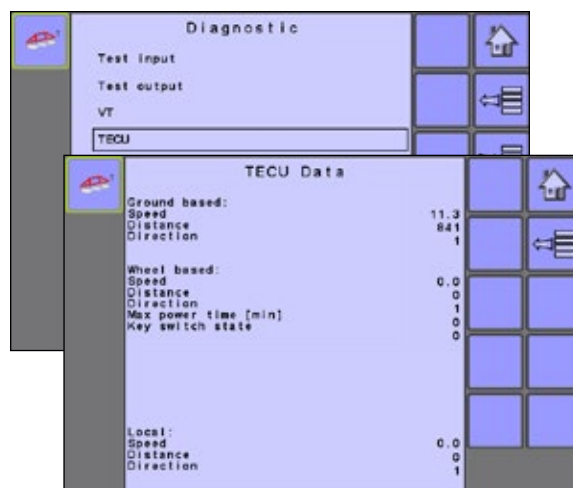

ISOBUS Job Computer: IC34 Sprayer

About

The About screen provides information on the IC34 such as software version, build number, etc. This information may become useful in case of technical support.

Figure 6-52: About

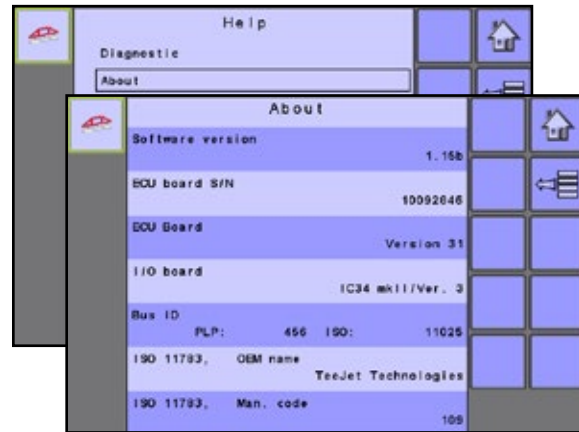

PC COMMUNICATION

Communication establishes the IC34's ability to communicate with an external computer.

MENU STRUCTURE TABLE

Counters	Job parameters	Machine	User interface	Help	PC communication
----------	----------------	---------	----------------	------	------------------

Figure 6-53: PC communication

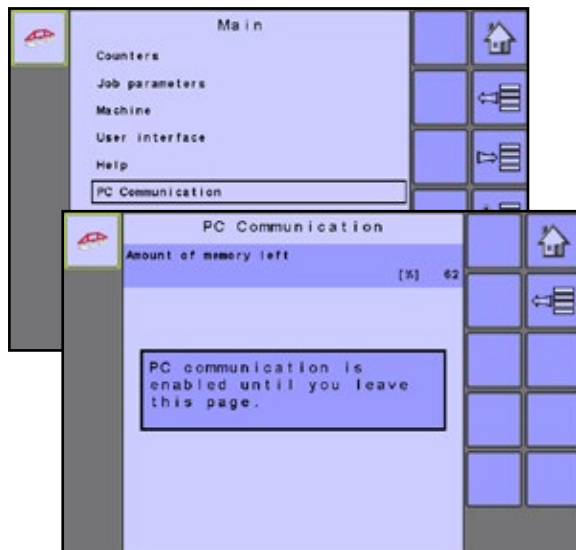

Amount of memory left

Displays the console's memory availability for storage and file transfer.

APPENDIX A - FACTORY SETTINGS & RANGES

JOB PARAMETERS

Description	Factory setting	Range	User setting
Active trip counter	1	1 - 15	1
			2
			3
			4
			5
			6
			7
			8
			9
			10
			11
			12
			13
			14
			15
Preset application rate no.1	0.0 l/ha	0.0 - 6553	no.1
Preset application rate no.2	0.0 GPA (UK)	0.0 - 583.4 (UK)	no.2
Preset application rate no.3			no.3
Nozzle	Established under Machine--> Implement parameters--> Nozzle preset setup		
Use shortened outer sections	No	Yes No	
Circulation	No	Yes No	
Idle pressure	0.0	0.0 - 9.9	

MACHINE

Tank filling

Description	Factory setting	Range/options	User setting
Desired content	0 l	0 - 9997	
Actual content	0 kgN	0 - 5443	
	0 lbN (UK)	0 - 12000	
Density	Water	Water Fertiliser	
Density factor	0.80 kg/l	0.80 - 2.00	
	8.02 lb/gal (UK)	8.02 - 20.04 (UK)	
Filling status	Inactive	Active	
		Inactive	

Operation

Description	Factory setting	Range/options	User setting
Boost percentage step	5%	1 - 20	
Speed source	Auto	Auto Ground based Wheel based Vehicle based Implement	
Simulated speed	Off	On Off	
Simulated speed - low	0.0 km/h	0.0 - 62.1	
Simulated speed - high	0.0 km/h	0.0 - 62.1	

Implement parameters

Section width

Description	Factory setting	Range	User setting
Section width	300 cm	0 - 9999	

Nozzle preset setup

Description	Factory setting	Range/options	User setting
Nozzle preset	1	1 - 5	1
			2
			3
			4
			5
Nozzle type	General	General User nozzle	
Nozzle size	025 (purple)	01 Orange 015 Green 02 Yellow 025 Purple 03 Blue 04 Red 05 Brown 06 Grey 08 White 10 Light blue 12 Telemagenta 15 Light green 20 Black	
Low pressure limit	1.0 bar	0.0 - 25.5	
High pressure limit	4.0 bar	0.0 - 25.5	
Reference flow	0.81 l/min 0.18 GPM (UK)	0.00 - 999.99 0.00 - 22.00 (UK)	
Reference pressure	2.00 bar 29 psi (UK)	0.10 - 99.99 1 - 1450 (UK)	

Regulation parameters

Description	Factory setting	Range	User setting
Minimum regulation pressure	0.7 bar	0-29	
Valve calibration, rough	19	1 - 19	
Valve calibration, fine	9	1 - 9	
Nozzle spacing	50 cm	1.0 - 1,999.9	
Regulation mode	Flow	Pressure Flow	
Stop regulation at flow low limit	No	Yes No	

Shortened sections

Description	Factory setting	Range/options	User setting
Use shortened outer sections	No	Yes No	
Left/right outmost section width	100 cm	20 - 9,999	

Calibrations

Flow sensor

Description	Factory setting	Range/options	User setting
Flow metre calibration	650 impulses/l	10 - 50,000	
Low limit	10 l/min	0.0 - 99.9	
High limit	200 l/min	0.0 - 999.9	

Liquid pressure sensor

Description	Factory setting	Range/options	User setting
Calibrate 'No pressure'	0	0 - 305	
Calibrate Maximum pressure'	25 bar	0 - 50	

Implement speed sensor

Description	Factory setting	Range/options	User setting
Pulses per distance	250 impulses/100 m	0 - 65,000	

Tank level sensor

Description	Factory setting	Range/options	User setting
Calibrate 'Empty'	0	0 - 500	
Calibrate 'Minimum level'	77	1 - 700	
Calibrate 'Maximum level'	671	1 - 1,024	
Calibrate 'Tank shape'	N/A	N/A	

Wind speed sensor

Description	Factory setting	Range/options	User setting
Wind sensor calibration	Hz/m/sec	0.01 - 99.98	

ISOBUS Job Computer: IC34 Sprayer

Alarm configurations

Description	Factory setting	Range/options	User setting
Tank content minimum	0 l	1 - 9,999	
Agitation tank level alarm	0 l	0 - 9,999	
Flow/pressure cross check	0 %	0 - 50	
Wind speed limit	5 m/sec	0 - 25	

USER INTERFACE

Description	Factory setting	Range/options	User setting
Use nozzle settings	Yes	Yes No	
Use preferred UT	No	Yes No	

APPENDIX B - UNIT SPECIFICATIONS

Dimensions	19.05 x 18.42 x 6.03 cm
Weight	0.644 kg
Connector	30 position Cinch pins. A1-K3 18 position Cinch pins. A1-F3
Environmental	Operating: -40 to +85°C Humidity: 90% non-condensing
Input/output	ISO 11783 (ISOBUS)
Power requirement	<9 watts @12 VDC

IC34 SPRAYER JOB COMPUTER USER MANUAL

Software Version 1.16-1.19



TeeJet Technologies

www.teejet.com

A Subsidiary of  **Spraying Systems Co.**[®]

020-027-EN-A4 R4 English-International
© TeeJet Technologies 2017