

AEROS 9040

USER GUIDE

Software version 4.33



TeeJet[®]
TECHNOLOGIES

A Subsidiary of  Spraying Systems Co.[®]

Copyrights

© 2018 TeeJet Technologies. All rights reserved. No part of this document or the computer programmes described in it may be reproduced, copied, photocopied, translated, or reduced in any form or by any means, electronic or machine readable, recording or otherwise, without prior written consent from TeeJet Technologies.

Trademarks

Unless otherwise noted, all other brand or product names are trademarks or registered trademarks of their respective companies or organizations.

Limitation of Liability

TEEJET TECHNOLOGIES PROVIDES THIS MATERIAL "AS IS" WITHOUT WARRANTY OF ANY KIND, EITHER EXPRESSED OR IMPLIED. NO COPYRIGHT LIABILITY OR PATENT IS ASSUMED. IN NO EVENT SHALL TEEJET TECHNOLOGIES BE LIABLE FOR ANY LOSS OF BUSINESS, LOSS OF PROFIT, LOSS OF USE OR DATA, INTERRUPTION OF BUSINESS, OR FOR INDIRECT, SPECIAL, INCIDENTAL, OR CONSEQUENTIAL DAMAGES OF ANY KIND, EVEN IF TEEJET TECHNOLOGIES HAS BEEN ADVISED OF SUCH DAMAGES ARISING FROM TEEJET TECHNOLOGIES SOFTWARE.

Table of contents

IMPORTANT SAFETY INFORMATION	V
GENERAL WARNINGS AND PRECAUTIONS	V
START SIMPLE GUIDANCE	1
NO.1 POWER ON	1
NO.2 HOME SCREEN	1
System Setup	1
RealView Camera Full Screen Video View	1
ISOBUS Universal Terminal View	1
Simple or Advanced Mode	1
NO.3 GO TO CONFIGURATION	2
1) Set Up the Local Cultural Settings	2
2) Set Up the GNSS	2
3) Set Up the Implement	3
Implement Settings per Equipment Present	3
Single Section Setup	3
Section(s) with ISOBUS Sprayer/Spreader Setup	4
Additional Settings per Implement Type	5
Section Numbers	5
Straight	5
Spreader – TeeJet	6
Lateral Implement Offset Distance Adjustment	8
GNSS Offset Adjustment Calculation	8
Lateral Implement Offset Adjustment	9
4) Set Up the Mapping Location	10
NO.4 START NEW JOB OR CONTINUE JOB	11
Simple Mode	11
Advanced Mode	11
NO.5 SET UP GUIDANCE	12
1) Choose a Guidance Mode	12
2) Establish an AB guideline	13
3) Create an Application Boundary	13
Arable Land Area on Status Bar	14
ADD RATE CONTROL	15
Guidance Screen Options	15
 MAPPING OPTIONS	16
Duplicating and Transferring Maps	16
Coverage Map	17
Polygons Map	17

Aeros 9040 field computer

Prescription Map.....	17
Application and Target Rate Maps	18
<i>Target Rates</i>	18
Colour Range Selection.....	18

INFORMATION ON GUIDANCE MODES **19**

Vehicle View.....	19
Field View.....	19
RealView Guidance	20

GUIDANCE MODES **20**

Straight AB Guidance.....	20
Curved AB Guidance	20
Adaptive Curve AB Guidance	20
Circle Pivot Guidance	21
Last Pass Guidance.....	21
NextRow Guidance	21
No Guidance.....	21

SCREENS OPTIONS **22**

GUIDANCE BAR **26**

STATUS BAR **27**

GUIDANCE FEATURES DETAILS **28**

A+ Nudge Feature	28
Azimuth Degree.....	28
Return to Point.....	29
Next Guideline Feature.....	30

REFRESH GNSS POSITION **30**

BOOMPILOT **31**

No Section Control Module	31
ISOBUS Sprayer.....	32
ISOBUS Spreader.....	33

ADDITIONAL IMPLEMENT OPTIONS **34**

NOZZLE SELECTION **34**

Preset	34
<i>Nozzle Sizes and Associated Colours</i>	34
Current Nozzle	35

DROPLET SIZE MONITOR **35**

Setup.....	35
Enable/Disable DSM	35
Nozzle Selection / Current Nozzle	35

Input/Output Module Pressure Sensor	35
Operation	36
Status Bar	36
<i>Droplet Size Chart</i>	36
Guidance Bar	36

REVERSE SENSE 37

BOOMPILOT SECTION CONTROL 38

NOZZLE FLOW MONITOR 40

ISOBUS SPRAYER OFFSETS 40

Self-propelled	41
Three Point Hitch	41
Trailed	42

DATA MANAGEMENT 43

Job Data	44
<i>Copy job data</i>	44
Machine Settings	45
<i>Copy machine profile</i>	45

SYSTEM CONFIGURATIONS 46



Safety information

TeeJet Technologies is not responsible for damage or physical harm caused by failure to adhere to the following safety requirements.

As the operator of the vehicle, you are responsible for its safe operation.

The Aeros 9040 in combination with any assisted/auto steering device is not designed to replace the vehicle's operator.

Do not leave a vehicle while the assisted/automatic steering is engaged.

Be sure that the area around the vehicle is clear of people and obstacles before and during engagement.

The Aeros 9040 is designed to support and improve efficiency while working in the field. The driver has full responsibility for the quality and work related results.

Disengage or remove any assisted/auto steering device before operating on public roads.

Aeros 9040 field computer

IMPORTANT SAFETY INFORMATION

All safety related and operating instructions should be read before the system is operated. Safe operation of machinery is the operators responsibility. Safety procedures must be posted close to the equipment and clearly visible to and legible by the operator. Safety procedures should meet all company and local regulations, as well as MSDS-requirements. For assistance, contact a local dealer.

Safety Alert Symbol Definitions:



DANGER! This symbol is reserved for the most extreme situations where serious personal injury or death is imminent.



WARNING! This symbol indicates a hazardous situation that could result in serious personal injury or death.



CAUTION! This symbol indicates a hazardous situation that could result in minor or moderate personal injury.



NOTE: This symbol addresses practices in which the operator should be aware.

GENERAL WARNINGS AND PRECAUTIONS



DANGER!

- Read and follow instructions. If instructions are unclear after reading the manual, please contact a local dealer.
- Keep children away from equipment.
- Do not operate machinery under the influence of alcohol or any illegal substance.
- Some systems include a fan heater. Never cover the heater otherwise there will be a serious danger of fire!



WARNING! ELECTRICAL / SHOCK HAZARDS

- Before working on any particular component, make sure that all power supplies have been switched off and cannot be accidentally switched on.
- Disconnect power leads before using an arc welder on equipment or anything connected to the equipment.
- Systems including frequency drives have a risk of electric shock due to residual voltage. It is not permissible to open the equipment neither to disconnect the system or any quick connection until 5 minutes after the power has been removed.
- Only operate the system from the power source indicated in the manual. If you are not sure of the power source, consult qualified service personnel.
- Do not use a high pressure cleaner to clean electrical components. This could damage electrical components and subject the operator to risk of electrical shock.
- The electrical supply to the equipment must be properly routed and connected to the equipment. All connections must meet the specified requirements.



WARNING! PRESSURIZED HYDRAULIC SYSTEMS

- Always wear personal protective equipment (PPE) when performing work on hydraulic systems.
- Adhere to the machine manufacture's approved maintenance instructions when working on the hydraulic system.
- Always turn equipment off when working on the hydraulic system. Take appropriate precautions when opening systems that have been previously pressurized.
- Be aware that hydraulic oil may be extremely hot and under high pressure.



WARNING! CHEMICAL HANDLING

- Always wear PPE when handling any chemical substance.
- Always follow safety labels and instructions provided by the chemical manufacturer or supplier.
- The operator should have full information on the nature and the quantity of the material to be distributed.
- **ADHERE TO FEDERAL, STATE AND LOCAL REGULATIONS REGARDING THE HANDLING, USE OR DISPOSAL OF AGRICULTURAL CHEMICALS.**



WARNING! PRESSURIZED SPRAY SYSTEM

- It is important to recognize proper safety precautions when using a pressurized spray system. Fluids under pressure can penetrate skin and cause serious personal injury.
- The system pressure should never exceed the lowest rated component. Always know your system and all component capabilities, maximum pressures and flow rates.
- Filters can only be opened when the manual valves in front of and behind the filter are in closed position. If any appliance has to be taken out of the piping, manual valves in front of and behind this appliance have to be in closed position. If they are reinstalled, make sure that this happens correctly, that this apparatus is well aligned, and that all connections are tight.
- The plumbing supply to the equipment should meet all company and local regulations and must be properly routed and connected to the equipment. All connections must meet the specified requirements
- It is advised to drain and purge the liquid train when the equipment shall not be used for a longer period of time.



WARNING! AUTO STEERING SAFETY

- To prevent serious personal injury or death from being run over by the vehicle or automated motion of the steering system, never leave the vehicles operator seat with the system engaged.
- To prevent serious personal injury or death from being run over by the vehicle or automated motion of the steering system, verify the area around the vehicle is clear of people or obstacles before startup, calibration, tuning or engaging the system.
- Make sure equipment is tightly secured to the proper components.
- Never drive on public roads with system engaged.



CAUTION! EQUIPMENT SAFETY, MAINTENANCE, AND SERVICE

- The equipment should be operated only by properly trained, qualified personnel. They must have proven their skills in the operation of the equipment.
- Before using the equipment, the operator has to check if the equipment is in good condition and can be used safely. If not, the equipment cannot be used.
- All necessary PPE must be readily available to the operator at all times.
- Routinely check the system and components for wear and damage. Replace or repair when necessary.
- Only qualified authorized experts are allowed to repair or maintain the installation. The maintenance and operating instructions shall be rigidly observed and followed.
- A complete manual for the equipment must be available to the operator or maintenance technician at all times.



CAUTION! HARNESS CABLE AND HOSE SAFETY

- Routinely check all harness cables and hoses for damage or wear. Replace or repair when necessary.
- Do not route harness cables and hoses with sharp bends.
- Do not strap harness cables and hoses to lines with high vibration or spikes in pressure.
- Do not strap harness cables and hoses to lines transporting hot fluids.
- Protect harness cables and hoses from sharp objects, equipment debris, and material buildup.
- Allow sufficient length for harness cables and hoses to have free movement on sections that move during operation, and be sure that harness cables or hoses do not hang below the equipment.
- Allow sufficient clearance for harness cables and hoses from implement and machine operational zones.
- When cleaning equipment, protect harness cables from high pressure wash.



NOTE: TOUCH SCREEN CARE



NOTE: TOUCH SCREEN CARE

- Keep sharp objects away from the touch screen device. Touching the screen with a sharp object could result in damage to the display.
- Do not use harsh chemicals to clean the console/display. The correct way to clean a console/display is to use a soft damp cloth or anti-static wipe, similar to cleaning a monitor on a computer.



NOTE: RECOMMENDED REPLACEMENT PARTS

- The system has been designed with components that work together to provide the best system performance. When the system requires replacement parts, only TeeJet recommended components should be used to maintain proper system operation and safety.

START SIMPLE GUIDANCE

NO.1 POWER ON



Recommended Antenna Installation

The GNSS antenna should be mounted as far forward as possible on top of the cab on a metal surface of at least 10 cm x 10 cm.

Home Button

The Home button  provides a shortcut to the Home screen.

Power On/Off Button

On – Press the POWER button  to power on the console. Upon power up, the Aeros will begin its start up sequence.

Off – Press and briefly hold the POWER button  until a confirmation screen acknowledges shut down mode.

WARNING! Wait 10 seconds before restarting the console.

NO.2 HOME SCREEN

Once the power up sequence has completed, the Home screen will appear with the options to start a new job or continue an existing job.

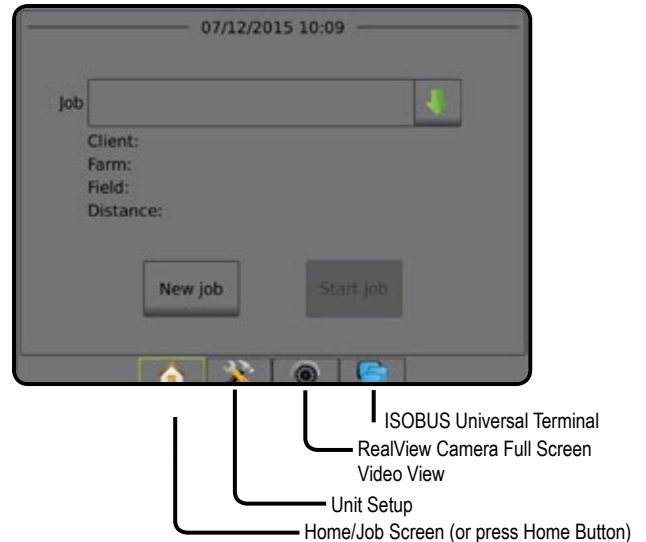

System Setup

System Setup is used to configure the console, the machine and its implements. Four side tabs access options for Machine/Implement Configuration, Data Management, Console Settings, and Tools.

RealView Camera Full Screen Video View

View video feed(s) and setup cameras without GNSS available. Options for RealView Guidance are not available on this screen.

ISOBUS Universal Terminal View

Access to an ISOBUS Electronic Control Unit (ECU) options and operation. This provides crop sprayer or spreader control when integrated into the implement of either capability.

Simple or Advanced Mode

To change between simple mode and advanced mode, see the configuration chapter under Data -> Options.

- ▶ Simple Mode – only one job will be available at a time. Only bounded area and coverage areas are displayed on the home screen. Only the current job is available for saving in Reports. Use with Fieldware Link is not available.
- ▶ Advanced Mode – more than one job will be available at any time. Client, farm, field and job names; bounded and coverage areas; application time; and distance from selected job are displayed on the home screen. All saved job profiles can be exported as a PDF, SHP or KML file to a USB drive using Data -> Reports.

NO.3 GO TO CONFIGURATION

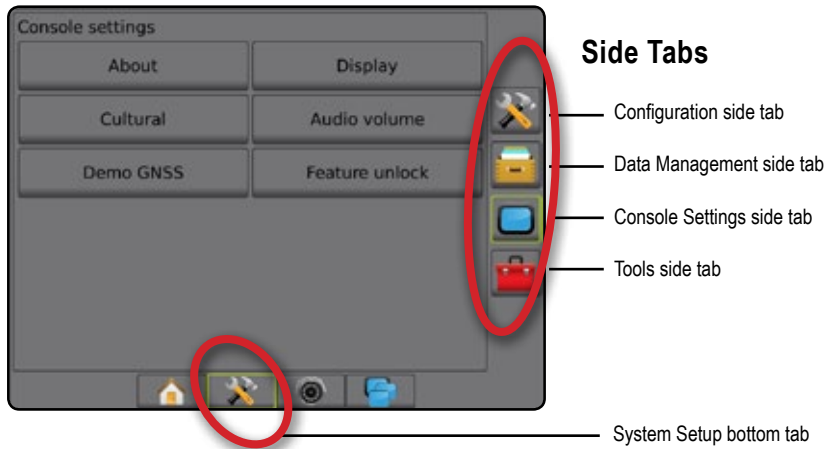

From the Home screen, select the System Setup bottom button to configure the console, the machine and its implements. Four side tabs access options for Machine/Implement Configuration, Data Management, Console Settings, and Tools.



1) Set Up the Local Cultural Settings

Cultural is used to configure units, language, and time zone settings for the Aeros console and any Electronic Control Units (ECUs) in the system.



NOTE: The languages available in a particular ECU may vary.

1. Press SYSTEM SETUP bottom tab .
2. Press CONSOLE side tab .
3. Press **Cultural**.
4. Select from:
 - ▶ Units – used to define the system units
 - ▶ Language – used to define the system language
 - ▶ Time Zone – used to establish the local time zone



2) Set Up the GNSS

GNSS Receiver Configuration is used to configure GNSS Type, GNSS Port, GNSS Data Rate, and PRN, and other GNSS parameters, and to view GNSS status information.

1. Press SYSTEM SETUP bottom tab .
2. Press CONFIGURATION side tab .
3. Press **GNSS Receiver Configuration**.
4. Select from:
 - ▶ GNSS Type – sets to accept GNSS source transmissions: GPS, GLONASS, SBAS (with or without DGPS Required)
 - ▶ GNSS Port – sets GNSS communication port to either Internal or External
 - ▶ GNSS Data Rate – when using the internal GNSS receiver, sets the GNSS Port baud rate and frequency of NMEA messages available on the console RS232 port
 - Fast (115,200 + 10 Hz) – 115,200 baud rate, GGA @ 10 Hz, VTG @ 10 Hz, ZDA @ 1 Hz
 - Slow (19,200 + 5 Hz) – 19,200 baud rate, GGA @ 5 Hz, VTG @ 5 Hz, ZDA @ 1 Hz
 - ▶ GNSS Status Information – displays current GNSS status information
 - ▶ Programme – only TeeJet support technicians should use this feature
 - ▶ PRN – selects the first of two possible SBAS PRN's to provide SBAS correction data. Set to **Automatic** for automatic PRN selection.
 - ▶ Alternate PRN – when PRN is not automatic, allows possible selection of a second SBAS PRN to provide correction data
 - ▶ Show refresh GNSS position button – establishes if the refresh GNSS position button is available on the guidance screens.

5. Press NEXT PAGE arrow  to set up the selected specific GNSS options.
6. Select:
 - ▶ GPS – single point uncorrected position data based on GPS only with a GGA QI of “1” is accepted.
NOTE: GPS is always selected.
 - ▶ GPS+GLONASS – single point uncorrected position data based on GPS and GLONASS with a GGA QI of “1” is accepted.
 - ▶ GPS+SBAS – either single point uncorrected or SBAS corrected position data are accepted - GGA QI of “1” or “2” (3, 4 or 5 are also accepted).
 - ▶ GPS+GLONASS+SBAS – either single point uncorrected or SBAS corrected position data are accepted - GGA QI of “1” or “2” (3, 4 or 5 are also accepted).
 - ▶ GPS+GLONASS+SBAS+DGPS – only GGA data with a QI value of “2” or higher is accepted (3, 4 or 5 are also accepted).
NOTE: All console based mapping, application and guidance functions are ceased if the GGA QI value drops below “2” with this setting checked.
7. Exit this screen to begin initializing the GNSS receiver. This takes about a minute, and the console will not respond until complete.

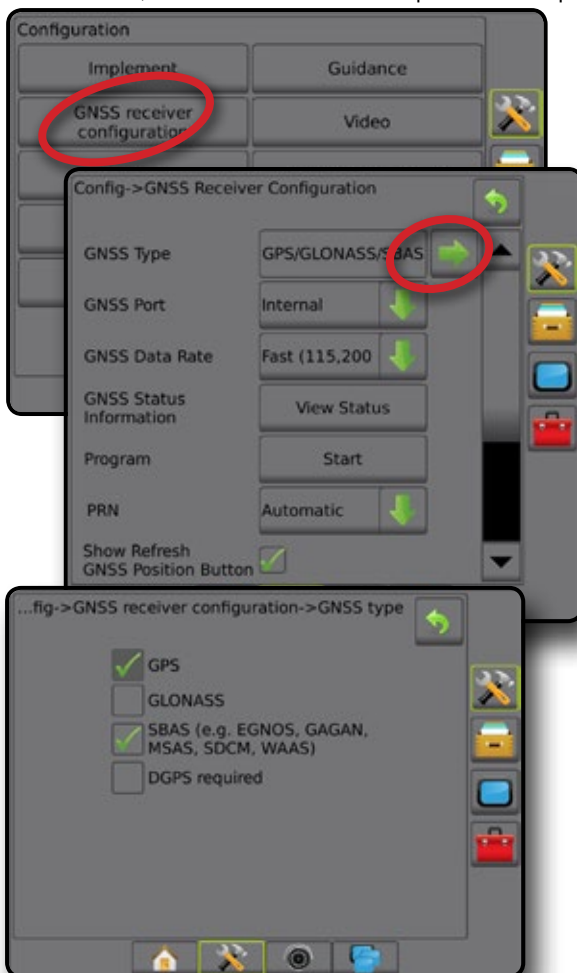

3) Set Up the Implement

Implement Setup is used to establish the various settings associated with straight mode, spreader mode, or staggered mode. Available settings will vary depending on the specific equipment present in the system.

Implement Settings per Equipment Present

This section includes setup options for these implement configurations:

- ▶ Single Section
- ▶ Section(s) with ISOBUS Sprayer/Spreader Setup

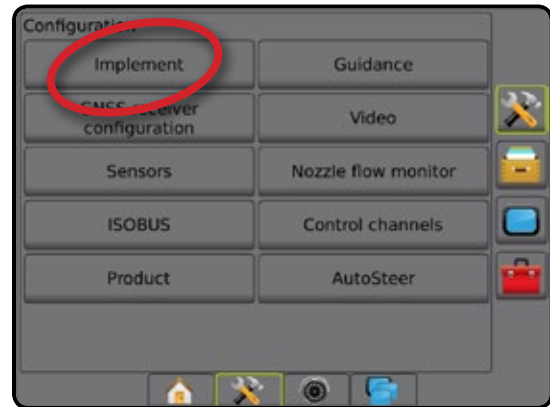

Single Section Setup

Single Section Setup is used when a SmartCable, Section Driver Module (SDM) or Switch Function Module (SFM) is not on the system (that is, no section control is present). The entire boom or delivery area is considered to be one section.

1. Press CONFIGURATION side tab .
2. Press **Implement**.
3. Select from:
 - ▶ Machine Type [when available] – used to select the type of machine that most closely represents your machine
 - ▶ GNSS Antenna Height [when available] – used to measure the height of the antenna from the ground
 - ▶ Implement Type – used to select the layout of the sections for the applied product location (*see Implement Type section for additional details*)
 - ▶ Working/ Application Width – used to enter the total width of the implement. Range is 1.0 to 75.0 metres.
 - ▶ Droplet Size Monitor [when available] – used to enable droplet size monitoring for up to five preselected sprayer nozzles
 - ▶ Nozzle Selection [when available] – used to select the type of sprayer nozzle (series and capacity) for determining droplet size information
 - ▶ Applied Alert – used to establish an alert to signal when exiting or entering an applied area

Aeros 9040 field computer

- ▶ BoomPilot Icon – used to activate the guidance screen icon for manually controlling on-screen application painting
4. Press NEXT PAGE arrow ➡ to set up specific implement options..

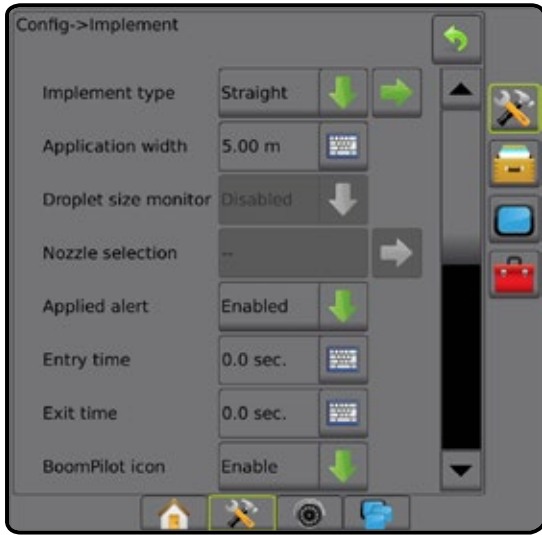

Section(s) with ISOBUS Sprayer/Spreader Setup

Some Implement options are completed on the ISOBUS ECU. When these options are also available in the Implement Setup section, they will be greyed out or unavailable.

1. Press CONFIGURATION side tab
2. Press **Implement**.
3. Select from:
 - ▶ Machine Type [when available] – used to select the type of machine that most closely represents your machine
 - ▶ GNSS Antenna Height [when available] – used to measure the height of the antenna from the ground
 - ▶ Implement Type – used to select the layout of the sections for the applied product location
 - ▶ Application Width [Straight Implement Type completed on ISOBUS ECU] – used to display the total width of the implement as entered on the ISOBUS sprayer
 - ▶ Working Width [Spreader Implement Type completed on the ISOBUS ECU] – used to display the total width of the implement as entered on the ISOBUS spreader
 - ▶ Droplet Size Monitor [available only with Pressure Sensor Interface Kit] – used to enable droplet size monitoring for up to five sprayer nozzles
 - ▶ Nozzle Selection [Straight Implement Type completed on the ISOBUS ECU] – used to display the type of sprayer nozzle as entered on the ISOBUS sprayer

- ▶ BoomPilot Start Mode – used to establish the mode in which a job is started.

- Automatic – automatic section control is enabled and section activation and/or on screen mapping will be controlled by GNSS and speed
- Off – automatic section control is disabled but section activation and/or on screen mapping can be manually enabled by using a switchbox or the BoomPilot icon in the Navigation and Guidance Options on the guidance screens

4. Press NEXT PAGE arrow ➡ to set up specific implement options.

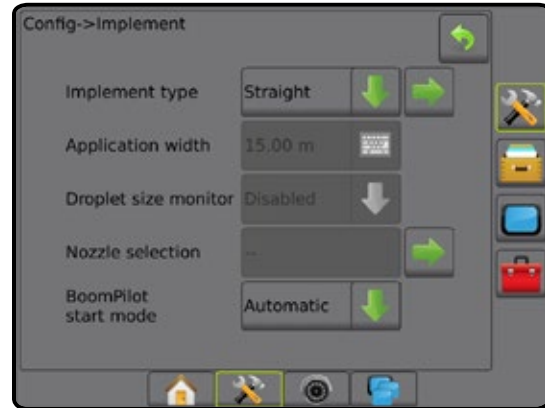

Additional Settings per Implement Type

Implement Type selects the type of application pattern that most closely represents your system.

- In Straight Mode – the boom sections have no length and are on a line a fixed distance from the antenna
- In Spreader Mode – a virtual line is created in line with the delivery disks from which the application section or sections can vary in length and can be at different distances from the line (availability depends on the specific equipment in the system)
- In Staggered Mode – a virtual line is created in line with Section 1 from which the application section or sections have no length and can be at different distances from the line (availability depends on the specific equipment in the system)

Figure 1: Implement Type – Straight

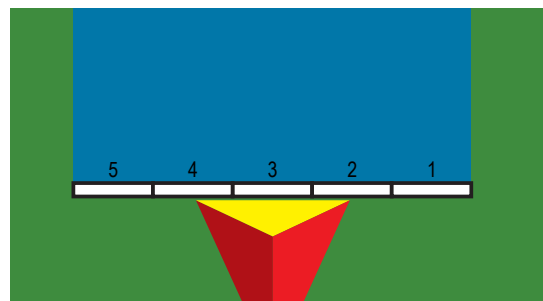

Figure 2: Implement Type – Spreader

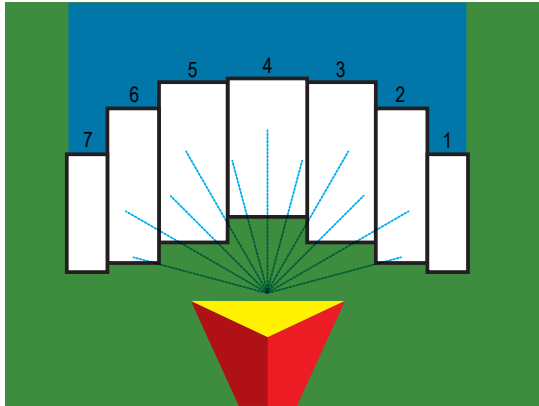
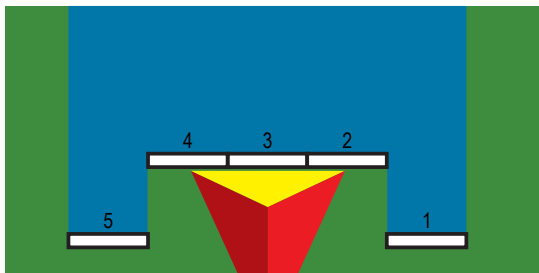

Figure 3: Implement Type – Staggered



Section Numbers

Sections are numbered from left to right while facing in the machine's forward direction.

Straight

The boom sections have no length and are on a line a fixed distance from the antenna.

1. Select **Straight** implement type on Implement screen.
2. Press Implement Type NEXT PAGE arrow .
3. Select from:
 - ▶ Connection Point In-line Offset Direction ③ [ISOBUS only] – establishes if reference point ② is located in front of (forward) or behind (backward) the GNSS antenna while facing in the machine's forward direction

- ▶ Connection Point In-line Offset Distance ③ [ISOBUS only]– measured in parallel to the centreline of the machine, defines the in-line distance from the GNSS antenna to reference point ②
- ▶ Connection Point Lateral Offset Direction ④ [ISOBUS only]– defines the lateral direction, either left or right, from the centreline of the machine to the centre of reference point ② while facing in the machine's forward direction
- ▶ Connection Point Lateral Offset Distance ④ [ISOBUS only]– defines the lateral distance from the centreline of the machine to the centre of reference point ②
- ▶ Implement In-line Offset Direction ① – displays if the implement is located in front of (forward) or behind (backward) the GNSS antenna while facing in the machine's forward direction
- ▶ Implement In-line Offset Distance ① – measured in parallel to the centreline of the machine, displays the in-line distance from the GNSS antenna to the implement
- ▶ Implement Lateral Offset Direction ② – displays the lateral direction, either left or right, from the centreline of the machine to the centre of the implement while facing in the machine's forward direction
- ▶ Implement Lateral Offset Distance ② – displays the lateral distance from the centreline of the machine to the centre of the implement
- ▶ Overlap – used to define the amount of overlap allowed when using automatic boom section control
- ▶ Delay On Time – used to set the time when the section will switch on when entering an area that has not been applied
NOTE: If the application turns on too soon when entering an unapplied area, decrease the Delay On Time. If the application turns on too late, increase the Delay On Time.
- ▶ Delay Off Time – used to set the time when the section will switch off when entering an area that has been applied
NOTE: If the application turns off too soon when entering an unapplied area, decrease the Delay Off Time. If the application turns off too late, increase the Delay Off Time.

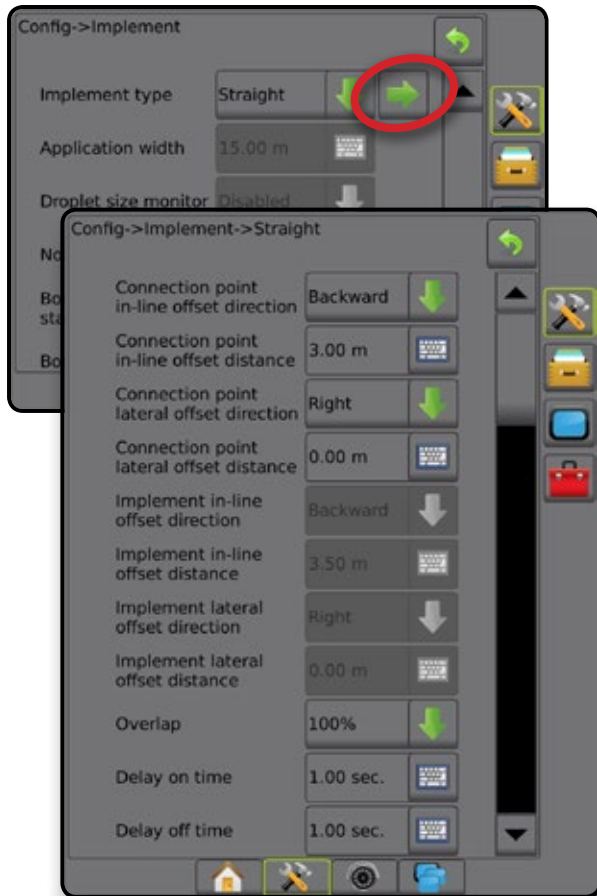

Figure 4: Implement Offset Directions and Distances

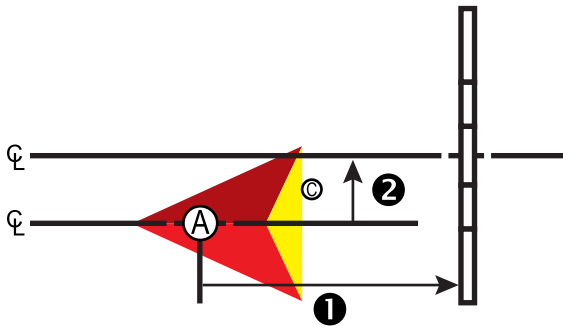
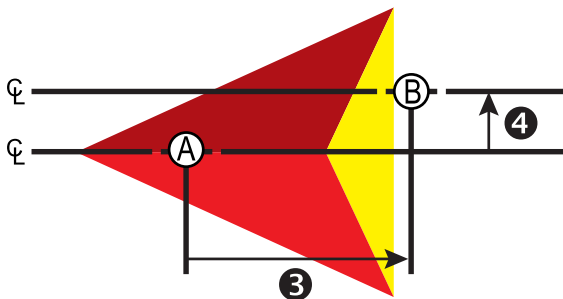

Figure 5: Connection Point Offset Directions and Distances



- Ⓐ – Centre of the GNSS antenna
- Ⓑ – Reference point
- ❶ – Implement In-line Offset Direction/Distance
- ❷ – Implement Lateral Offset Direction/Distance
- ❸ – Connection Point In-line Offset Direction/Distance
- ❹ – Connection Point Lateral Offset Direction/Distance

Spreader – TeeJet

A virtual line is created in line with the delivery disks from which the application section or sections can vary in length and can be at different distances from the line (availability depends on the specific equipment in the system).

1. Select **Spreader** implement type on Implement screen.
2. Press Implement Type NEXT PAGE arrow ➡.
3. Select from:
 - ▶ Setup type – used to select **TeeJet** spreader type
 - ▶ Antenna to Disks In-line Offset Distance ❶ – measured in parallel to the centreline of the machine, defines the in-line distance from the GNSS antenna to the disks, or dispersal mechanism
 - ▶ Implement Lateral Offset Direction ❷ – defines the lateral direction, either left or right, from the centreline of the machine to the centre of the implement while facing in the machine's forward direction
 - ▶ Implement Lateral Offset Distance ❷ – defines the lateral distance from the centreline of the machine to the centre of the implement
 - ▶ Overlap – used to define the amount of overlap allowed when using automatic boom section control
 - ▶ Delay On Time – used to set the time when the section will switch on when entering an area that has not been applied

NOTE: If the application turns on too soon when entering an unapplied area, decrease the Delay On Time. If the application turns on too late, increase the Delay On Time.

- ▶ Delay Off Time – used to set the time when the section will switch off when entering an area that has been applied

NOTE: If the application turns off too soon when entering an unapplied area, decrease the Delay Off Time. If the application turns off too late, increase the Delay Off Time.

- ▶ Spread Offset Distance ❸ – used to set the distance between the disks or dispersal mechanism and where product initially hits the ground on Section 1.
- ▶ Section Offsets ❹ – used to set the offset distance from section 1 (the Spread offset line) to the leading edge of each section. Section 1 is always 0. All other sections can be different distances.
- ▶ Section Lengths ❺ – used to set the length of application in each section. Each section can be a different length.

NOTE: Sections are numbered from left to right while facing in the machine's forward direction.

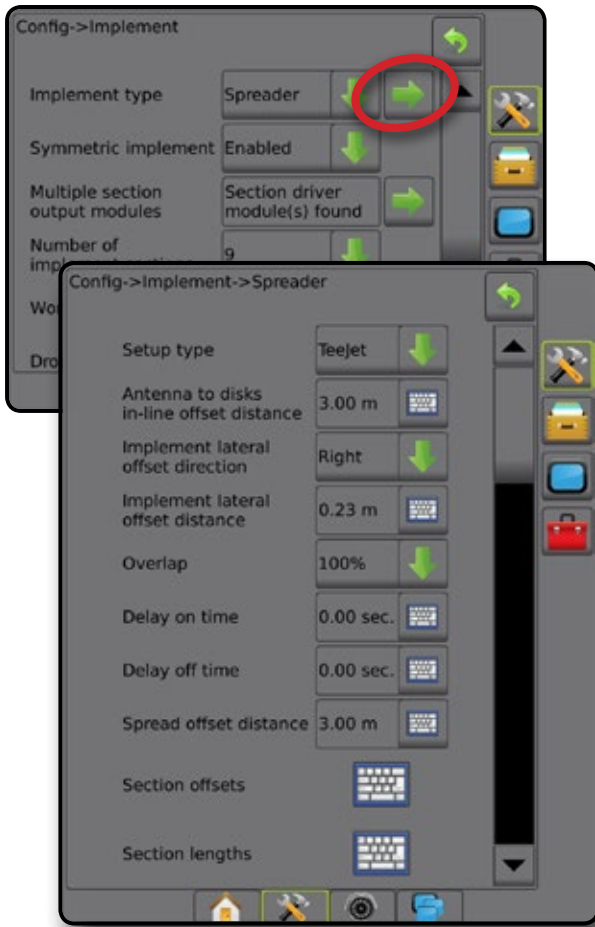

Figure 6: Distances and Length

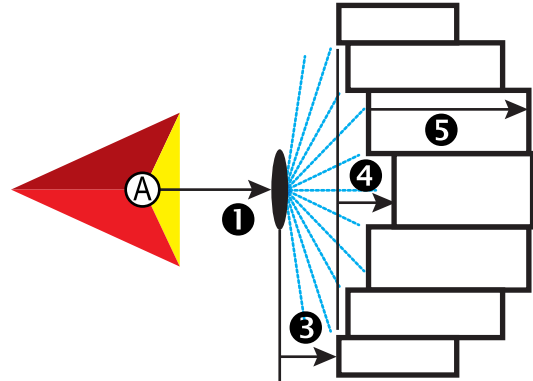
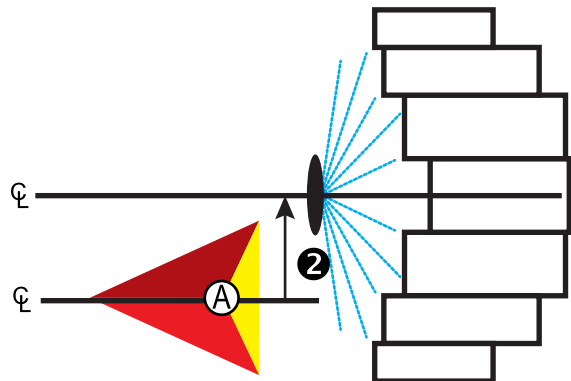

Figure 7: Lateral Offset Direction and Distance



- Ⓐ – Center of the GNSS antenna
- ❶ – Antenna to Disks In-line Offset Distance
- ❷ – Implement Lateral Offset Direction/Distance
- ❸ – Spread offset distance
- ❹ – Section offsets
- ❺ – Section lengths

Lateral Implement Offset Distance Adjustment

Lateral implement offset distance is used to enter the distance from the centre line of the machine to the centre of the implement. When on-screen mapping shows no overlap or gap, yet field application produces an overlap or gap consistently to only one side in the direction of travel, an adjustment to the lateral implement offset distance should be calculated and made to the implement offset distance value.

If using a self-propelled sprayer or spreader, use the GNSS Offset Adjustment Calculation to calculate the implement offset distance adjustment.

If using a pull behind or trailed implement, use the Implement Offset Adjustment Calculation to calculate the implement offset distance adjustment.

NOTE: While using assisted/auto steering, if on-screen mapping shows overlaps and gaps, adjustments may need to be made to the assisted/auto steering settings.

GNSS Offset Adjustment Calculation

To calculate a GNSS offset adjustment using the same guideline:

1. Create a straight AB line.
2. With assisted/auto steering engaged, drive pass **1** at least 30 metres, and place flags at the draw bar or next to the machine.
3. Turn around and engage assisted/auto steering on pass **2** on the same AB guideline. Place flags at the draw bar or next to the machine, or stop while on the AB guideline next to the flags you placed on pass **1**.
4. Measure the difference **3** between the flags of pass **1** and pass **2**.
5. Divide the measured distance **3** in half. This difference will be the offset adjustment.
6. Increase or decrease the offset distance by the offset adjustment value determined in Step 5, and repeat the test. The lateral antenna offset distance has been adjusted correctly when the vehicle's wheel tracks are in the same location driving in both directions. If this adjustment results in the lateral antenna offset distance being adjusted by more than 10 cm, the Automatic Calibration should be redone.

Field Application Overlap	Current Offset Settings		
	Offset Direction = Left	Offset Direction = Right	Offset Direction = Right Offset Distance = 0 m
To the right of pass 1	Decrease distance offset value	Increase distance offset value	Increase distance offset value
To the left of pass 1	Increase distance offset value	Decrease distance offset value	Change to implement offset direction to left and increase distance offset value

Figure 8: GNSS Offset Distance

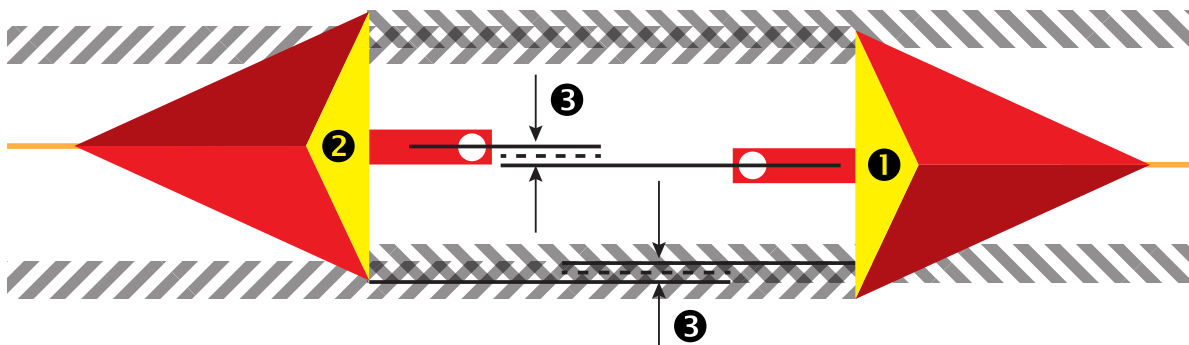

Lateral Implement Offset Adjustment

To calculate an implement offset adjustment using adjacent guidelines:

1. Create a straight AB line.
2. With assisted/auto steering engaged, drive pass ① as if you were operating the implement, and place flags at the outside edges of the implement.
3. Turn around and engage assisted/auto steering on pass ② on the adjacent AB guideline. Place additional flags at the outside edges of the implement or stop while on the AB guideline next to the flags you placed on pass ①.
4. Measure the difference ⑤ between the flags of pass ① and pass ②.
5. Divide the measured distance ⑤ in half. This difference will be the offset adjustment.
6. Increase or decrease the offset distance ④ as needed dependent on where the field application overlap occurs and the current implement offset direction setting.

Field Application	Current Offset Settings		
	Offset Direction = Left	Offset Direction = Right	Offset Direction = Right Offset Distance = 0 m
Overlap on the right of pass ① or Gap on the left of pass ①	Increase distance offset value	Decrease distance offset value	Increase distance offset value
Overlap on the left of pass ① or Gap on the right of pass ①	Decrease distance offset value	Increase distance offset value	Change to implement offset direction to left and increase distance offset value

Figure 9: Lateral Implement Offset Distance and Direction

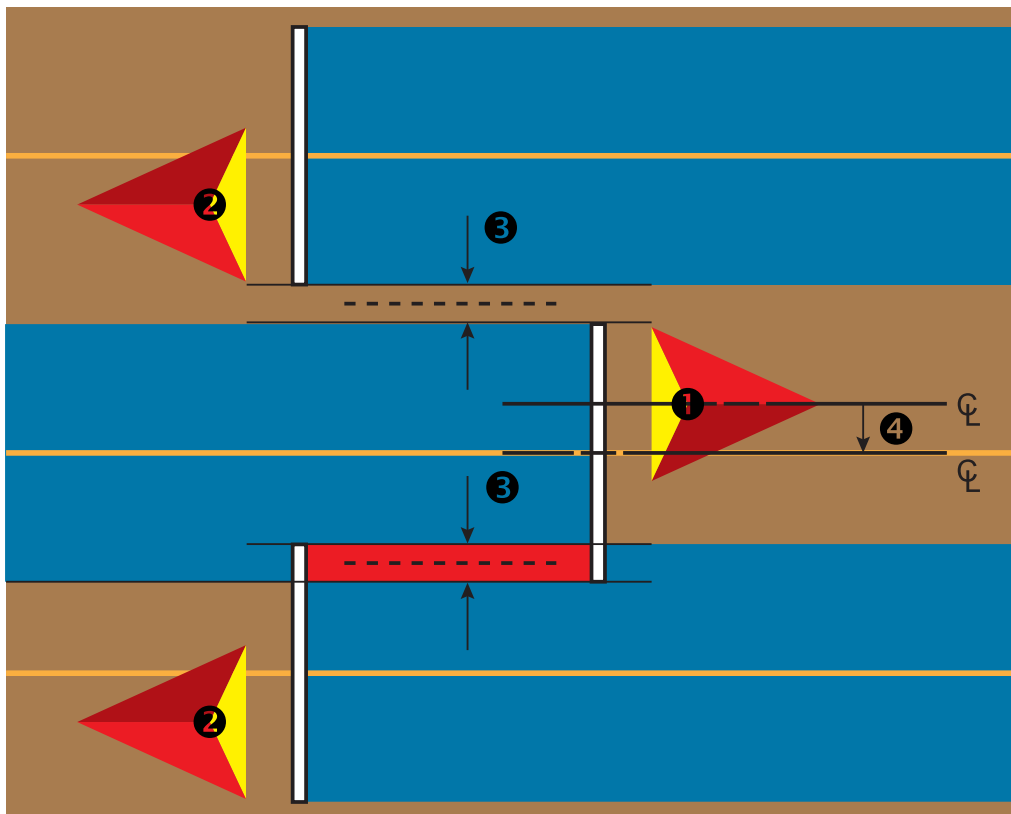

4) Set Up the Mapping Location

Mapping location establishes the location from which boundary and polygon mapping will take place.





1. Press CONFIGURATION side tab .
2. Press **Mapping and Guidance**.
3. Select from:
 - ▶ Mapping Location – establishes the layout of the location from which the boundary or polygon will be mapped.
 - Default Location – While creating an exterior boundary or polygon, the line will be to the exterior of the outermost active section. While creating an interior boundary, the line will be to the interior of the innermost active section. If no sections are active, the boundary will be marked to the end of the outermost section.
 - User Entry – in-line and lateral offset from the GNSS antenna directions and distances can be specified by the user. Up to five (5) user entries can be created. See “User Entered Mapping Location” for details.
 - ▶ Guidance Width – used to set the distance between guidelines
 - ▶ Guidance Sensitivity – sets the distance around the guideline that is perceived as zero error.
4. Select user entry location from the Mapping Locations drop-down options.
5. Press MAPPING LOCATION NEXT PAGE arrow  to set up the selected specific mapping location options.
6. Select:
 - ▶ Location Name – used to enter the name of the mapping location for the current user entry selected
 - ▶ Mapping Location In-line Offset Direction – used to select whether the mapping location is located in front of or behind the GNSS antenna as the vehicle moves in a forward direction
 - ▶ Mapping Location In-line Offset Distance – used to define the in-line distance from the GNSS antenna to the mapping location
 - ▶ Mapping Location Lateral Offset Direction – used to select the lateral direction from the centreline of the machine to the mapping location while facing in the machine’s forward direction
 - ▶ Mapping Location Lateral Offset Distance – used to define the lateral distance from the centreline of the machine to the mapping location
7. Press RETURN arrow  to return to the Mapping and Guidance screen or CONFIGURATION side tab  to return to the main Configuration screen.

Figure 10: User Entered Mapping Location



NO.4 START NEW JOB OR CONTINUE JOB

Once the power up sequence has completed, the Home screen will appear with the option to start a new job or continue an existing job. The console must have GNSS before starting or continuing a job. **Setup for the specific machine and its components must be completed before starting a job.** Once a job is active, some setup options can no longer be changed. To change between simple and advanced mode, go to Data-> Options-> Job Mode in the System Setup.

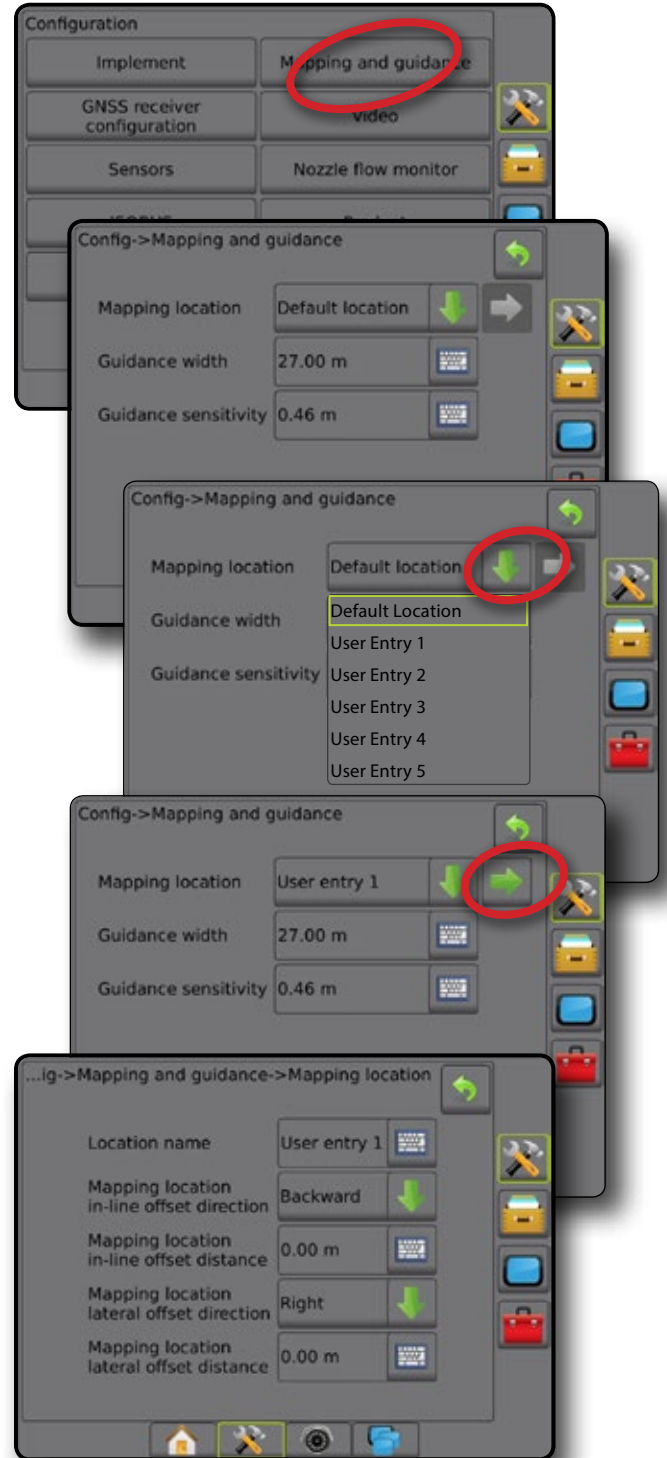
Simple Mode

In simple mode, only one job will be available at a time.

New Job

1. On the Home screen , press **New Job**.

Continue Job

1. On the Home screen , press **Continue**.

If the current job is in a UTM zone other than the current or adjacent UTM zone **Continue** will be disabled.

Close Job

1. On the Home screen , press **Close Job**.

To create a report of the job when closing a job, Insert a USB drive into the USB port of the console before pressing "Close Job".

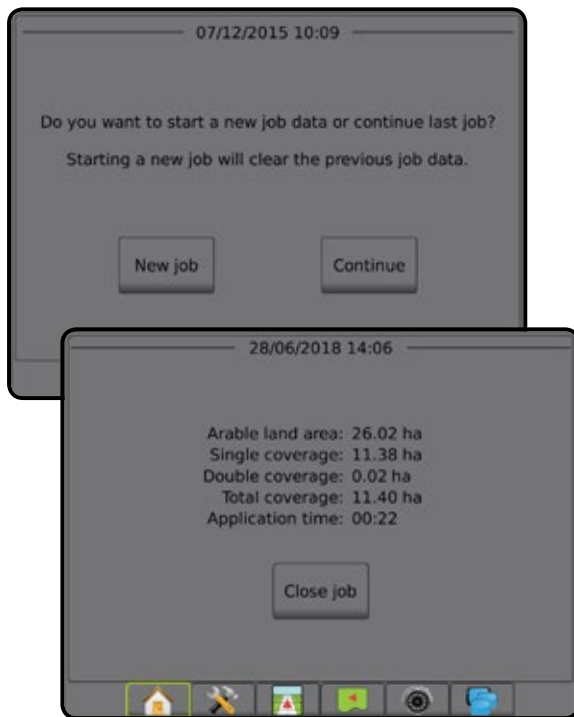

Advanced Mode

In advanced mode, more than one job will be available at any time.

Client information, farm information, field information, and prescription maps can only be inputted using Fieldware Link. A job name can only be edited using Fieldware Link.

A user can duplicate jobs for reuse of guidelines, boundaries, applied data, prescription map and/or polygons using Fieldware Link or Data -> Job Data -> Manage in the console.



New Job

1. On the Home screen , press **New Job**.
2. Press:
 - ▶ Yes – to automatically generate a name
 - ▶ No – to enter a name using the on screen keyboard

Client, farm, and field information are inputted using Fieldware Link.

Start Job

The Aeros 9040 is programmed with a field finder tool to assist the user in finding the job closest to the vehicle's location. With GNSS acquired, the job pick list will be updated every ten seconds. During this update, the list of jobs is sorted by distance and the closest two jobs are displayed on the top of the list. The remaining jobs are listed beneath these.

1. On the Home screen , press DOWN arrow  to access the list of jobs saved in the console.
2. Select the job name to be started/continued.
3. Press **Start Job**.

Close Job

1. On the Home screen , press **Close Job**.

To create a report of the job when closing a job, Insert a USB drive into the USB port of the console before pressing **Close Job**.

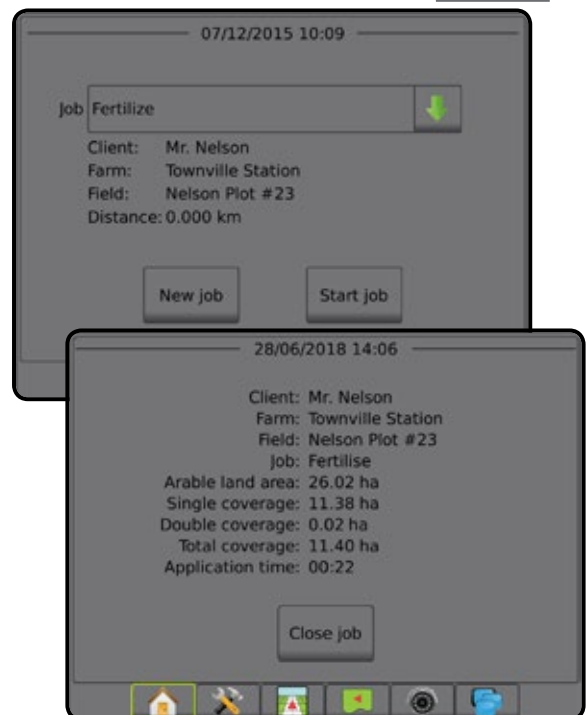

NO.5 SET UP GUIDANCE

1) Choose a Guidance Mode

Three guidance screens assist in keeping you informed.

Vehicle View guidance creates a computer-generated image of the vehicle position displayed in the application area.

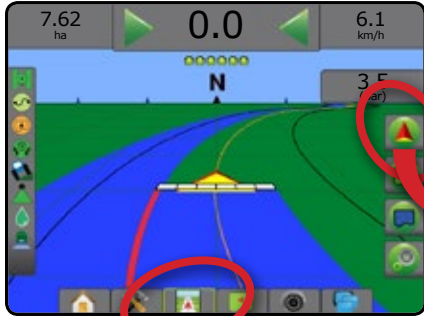









Field View guidance creates a computer-generated image of vehicle position and application area from an aerial perspective.



RealView guidance allows live video input to be displayed instead of a computer-generated image.



To choose a guidance mode:





2. Press NAVIGATION AND GUIDANCE OPTIONS tab  to display navigation options.
3. Press GUIDANCE MODE icon .
4. Select from:
 - ▶ No Guidance 
 - ▶ Straight AB Guidance 
 - ▶ Curved AB Guidance 
 - ▶ Circle Pivot Guidance 
 - ▶ Last Pass Guidance* 
 - ▶ NextRow Guidance* 
 - ▶ Adaptive Curve Guidance 

**Guidance options may not be available depending on assisted/automatic steering system installed.*

Figure 11: Choose a Guidance Mode



2) Establish an AB guideline

1. Drive to the desired location of Point A .
2. Press NAVIGATION AND GUIDANCE OPTIONS tab  to display navigation options.
3. Press MARK A icon .
4. Drive to the desired location of Point B .
5. Press MARK B icon  to establish the AB line.
6. "Would you like to name this guideline?"
Press:
 - ▶ Yes – to enter a name and save the guideline in the console
 - ▶ No – to automatically generate a name and save the guideline in the console

The console will begin providing navigation information.

NOTE: The MARK B Icon  is not available for selection (greyed out) until the minimum distance is travelled (3.0 metres in Straight or Curved guidance, 50.0 metres in Circle Pivot guidance).

NOTE: It is not necessary to drive the entire circumference of the centre pivot in order to initiate Circle Pivot Guidance.

Use CANCEL MARK icon  to cancel the Mark A command and revert to the previous guideline (when established).

Figure 12: Mark A Point





Figure 13: Mark B Point



3) Create an Application Boundary

Available on any guidance screen, the Boundaries and polygons tab displays exterior boundary, interior boundary and polygon options.

Application boundaries establish the work areas where product is or is not applied while using ASC or BoomPilot.



- Exterior Boundary  – establishes a work area where application will be applied while using ASC or BoomPilot.
- Interior Boundary  – establishes a work area where application will NOT be applied while using ASC or BoomPilot.

Boundaries can be established in all guidance modes. Up to 100 total exterior boundary and/or interior boundaries can be stored within a single job. Application is not required to map a boundary.

Using Data -> Job Data -> Manage or with Fieldware Link, a user can duplicate and edit jobs for reuse of boundaries for different applications over the same field.

Application is not required to map a boundary or polygon.



If mapping a boundary or polygon with one or more sections folded in and turned off, it is necessary to maintain this section configuration for the duration of the boundary or polygon pass. Any changes made to the number of sections turned on, and therefore the width of the machine after the boundary or polygon mapping process has started, will result in the application mapping the boundary or polygon at the outer edge of all the programmed sections – not necessarily those turned on at any given time during the boundary or polygon pass.

When mapping a boundary or polygon with some sections turned off, it is necessary to turn BoomPilot to Manual mode  and turn ON the master and section switches for all sections that will be used during the boundary or polygon pass. Once the boundary or polygon pass is complete the sections switches can be turned OFF, master switch remains ON, BoomPilot can be returned to Automatic mode  and automatic section control can then be used.

NOTE: If a boundary is mapped with some sections folded as described above, it may be necessary to use the A+ NUDGE icon  on the guideline over to the correct position for subsequent passes in the field.

Establishing an Exterior or Interior Boundary







To establish an exterior or interior boundary:

1. Drive to a desired location at the perimeter of the application area and orientate the vehicle in association to the established mapping location.
2. Press BOUNDARY AND POLYGON OPTIONS tab  to display boundary and polygon options.
3. Press MARK BOUNDARY icon  .
4. Verify that the Mapping location is correct.



◀ If the Mapping location is not correct, press **Cancel** then go to Configuration-> Mapping and guidance-> Mapping location.

5. Travel the perimeter of the application area.

While traveling, use as needed:

- ▶ Pause Boundary   – pauses the mark boundary process.
- ▶ Resume Boundary   – resumes the mark boundary process.
- ▶ Cancel Boundary   – cancels mark boundary process.

6. Finish the boundary:

- ▶ Automatic close – travel to within one swath width of the starting point. The boundary will close automatically (the white guideline will turn black).
- ▶ Manual close – press the FINISH BOUNDARY icon   to close the boundary with a straight line between the current location and the starting point.

NOTE: If the minimum distance is not travelled (five times the swath width), an error message will pop-up.

7. Press:

- ▶ Save – to save the boundary
- ▶ Delete – to delete the boundary

Figure 14: Exterior Boundary

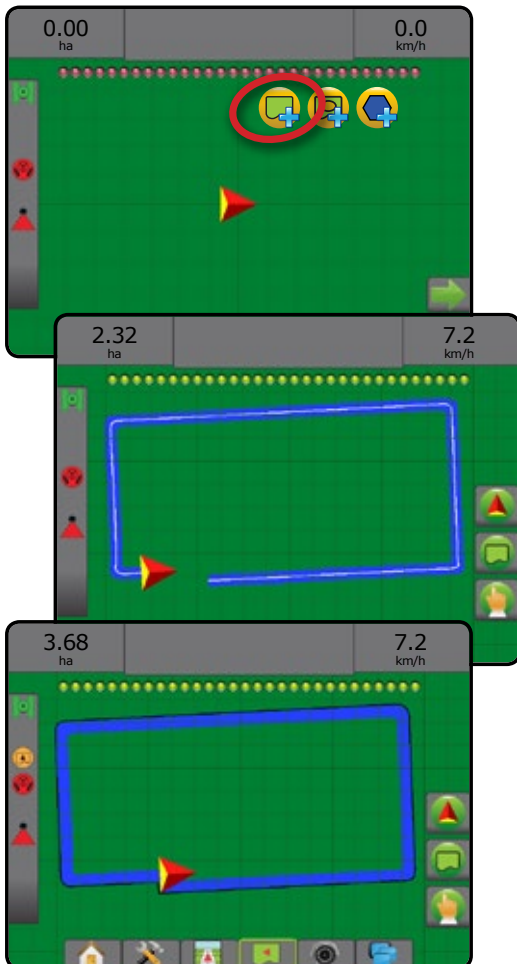
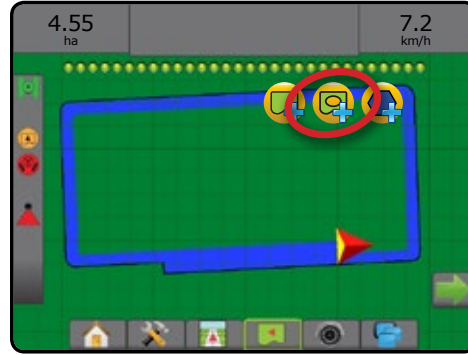

Figure 15: Add Interior Boundary



Delete Last Marked Boundary



Use DELETE BOUNDARY icon  to delete the last marked boundary (interior or exterior) from the current job. Press again to remove additional boundaries in order from last to first created.

Figure 16: Delete Last Marked Boundary

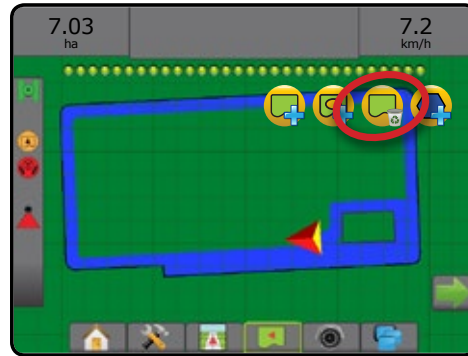

Arable Land Area on Status Bar

In reference to your current location, the IN ARABLE LAND AREA icon  or OUT OF ARABLE LAND AREA icon  is displayed on the Status Bar once a boundary is established.



1. Press ARABLE LAND AREA icon  .
 - ◀ Arable Land Area – total area of all exterior boundaries minus the area of all interior boundaries
 - ◀ Exterior Bounded Area – total area of all exterior boundaries
 - ◀ Interior Bounded Area – total area of all interior boundaries

Figure 17: Arable Land Area on Status Bar



ADD RATE CONTROL

NOTE: TeeJet Dual Control Module (DCM) is no longer supported and will not be referenced in this manual.

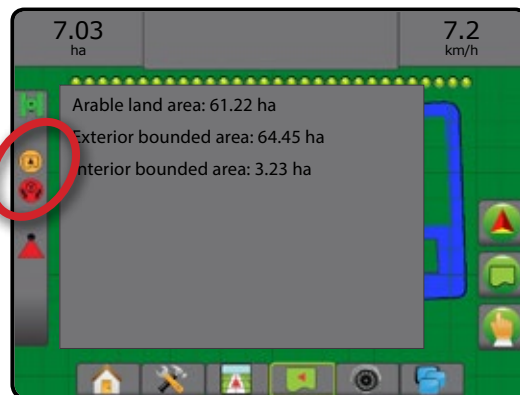
ISOBUS universal terminal (UT) gives access to an ISOBUS electronic control unit (ECU) options and operation. This provides crop sprayer or spreader control when integrated into the implement of either capability.

NOTE: For detailed setup instructions, refer to the specific ISOBUS user manual for the connected ECU.

1. Press UNIVERSAL TERMINAL bottom tab .

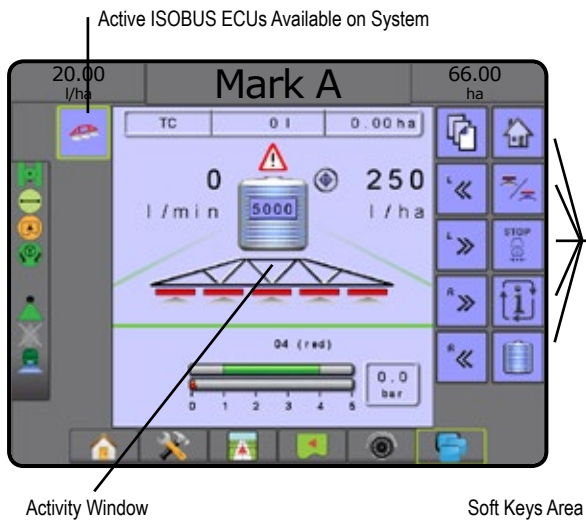

Guidance Screen Options

When a ISOBUS Electronic Control Unit (ECU) sprayer or spreader control is integrated into the implement, rate control options and mapping options are available on the Vehicle View and Field View guidance screens.

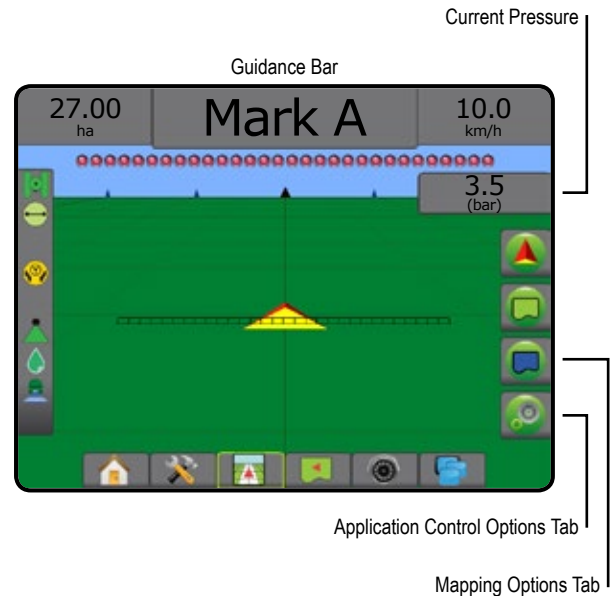

Ready for Operation

Upon starting up the system, an ISOBUS product may take a few minutes to load all required information or object pools.

Before starting a job, check to be sure the ISOBUS ECU is ready.

- Home Screen is available
- Tack Control (TC) is active – Active Trip Count Number should show “TC”



Current Pressure

Displays the current pressure to the nozzle.

Guidance Bar

In addition to the standard Guidance bar options, the following selectable information will become available with an ISOBUS ECU:

- ▶ Actual Application Rate – displays the current application rate
- ▶ Target Application Rate – displays the target application rate
- ▶ Volume/Product Applied – displays the volume or weight of product applied
- ▶ Tank/Bin Amount Remaining – displays the volume or weight of product remaining in the tank/bin

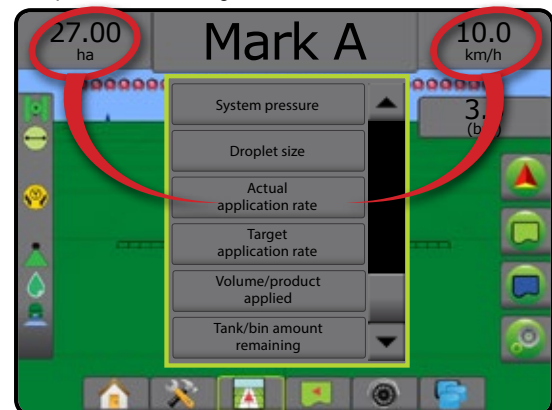









Aeros 9040 field computer

Mapping

GNSS-based product application mapping is available in Vehicle View or Field View. Mapping can record areas covered by the implement (Coverage) or how much product has been applied and where (Application) and can direct single- and variable-rate product application (Preset Target Rate and Prescription, respectively).

NOTE: For more information, see “Application Mapping”.

1. Press VEHICLE VIEW GUIDANCE bottom tab  or FIELD VIEW GUIDANCE bottom tab .
2. Press MAPPING OPTIONS tab .
3. Select one or more:
 - ▶ Coverage Map 
 - ▶ Polygons 
 - ▶ Prescription Map 
 - ▶ Application Map 
 - ▶ Target Rate Map 



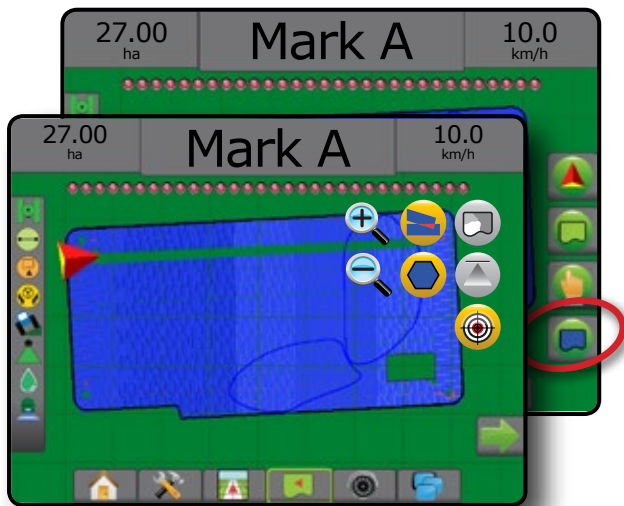

NOTE: Application Map and Target Rate Map cannot be selected simultaneously.



Application Control

Target Rate Percentage Increase/Decrease icons increase/decrease the application target rate per the established percentage set in the Machine Operation setup screen under Application Rate Step. Automatic regulation mode will automatically adjust the application rate based on the current speed in reference to the target rate.

NOTE: The Target Rate Percentage Increase/Decrease icons do the same adjustment as the Boost/Step Percentage Increase/Decrease Keys from the ISOBUS UT.

1. Press VEHICLE VIEW GUIDANCE bottom tab .
2. Press APPLICATION OPTIONS tab .
3. Select from:
 - ▶ Target Rate Percentage Increase  – establishes the required boost percentage step increase
 - ▶ Target Rate Percentage Decrease  – establishes the required boost percentage step decrease
 - ▶ Percentage Boost and Reset  – shows current boost percentage step and when pressed, zeros the boost percentage step

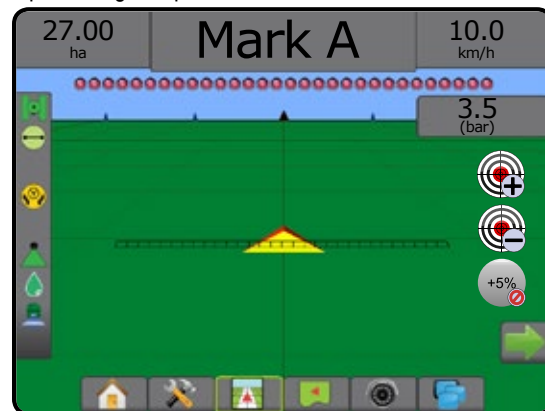

MAPPING OPTIONS

On vehicle view or field view guidance screens, in any guidance mode, the mapping options tab displays options to display polygon maps, coverage maps and application maps.

Polygon and coverage mapping are available when a polygon has been established.

GNSS-based product application mapping is available when a rate controller is on the system. Rate control mapping can record areas covered by the implement (Coverage) or how much product has been applied and where (Application), and can direct single- and variable-rate product application (Preset Target rate and Prescription, respectively).









NOTE: Before using mapping, set or verify product mapping options under Configuration->Product.

Duplicating and Transferring Maps

Maps are stored in the job data. Using Data-> Job Data, job data containing maps can be duplicated or transferred to Fieldware Link so the maps can be opened, viewed, edited, and printed, and transferred back to the console. See “Data management->Job data-> Transfer” and “Data Management-> Job Data-> Manage” in the System Setup chapter for details.

Using Data-> Reports, reports in multiple formats can be generated that contain data and any maps from the job.

To access application mapping:

1. Press VEHICLE VIEW GUIDANCE bottom tab  or FIELD VIEW GUIDANCE bottom tab .
2. Press MAPPING OPTIONS tab  to display mapping options.
3. Select one or more:
 - ▶ Coverage map  – shows areas covered by the implement, regardless of whether product was applied
 - ▶ Polygons  – shows all mapped polygons
 - ▶ Prescription map  – pre-loaded map that provides information to the rate controller for use in applying product
 - ▶ Application map  – shows how much product has been applied and where, using colour to indicate level in proportion to preset or automatically set maximum and minimum levels
 - ▶ Target Rate map  – shows the application rate that the rate controller attempted to achieve at each location

NOTE: Application Map and Target Rate map cannot be selected simultaneously.

Figure 18: Coverage, Polygon and Target Rate Maps



Coverage Map

 Coverage map showing areas covered by the implement. ISOBUS requires product to be applied.

- Coverage area – illustrates applied area and overlap:
 - ◀ Blue – one application
 - ◀ Red – two or more applications

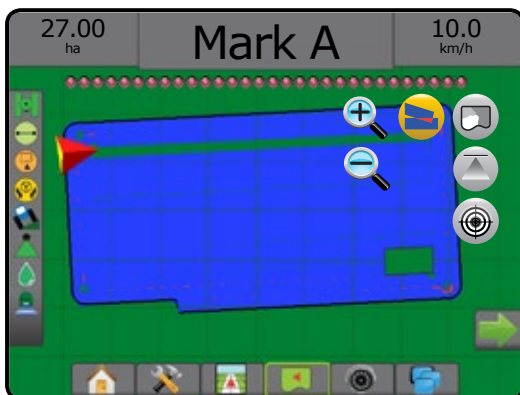

Polygons Map

 Polygon map shows all mapped polygons.

- Guidelines
 - ◀ Blue – polygon boundary line

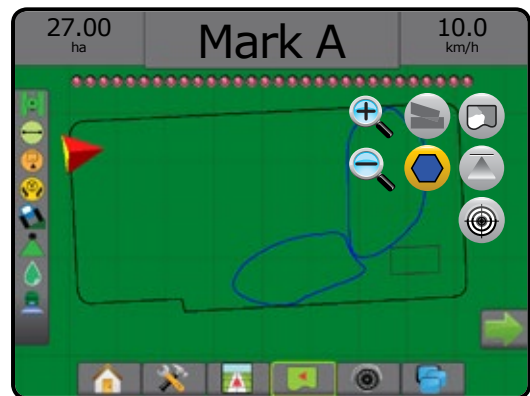

Prescription Map

 Prescription map is a pre-loaded map that provides information to the rate controller for use in applying product. Prescription maps contain geo-referenced product rate information. The Aeros 9040 can import job data containing Prescription maps for use with variable-rate application (VRA) using compatible rate controllers.

- Zone Lines:
 - ◀ Black when approaching the application zone.
 - ◀ White when within the application zone.
 - ◀ Other zones having the same rate will also be shown in white.
- Coverage Area – illustrates different prescription rate zones:
 - ◀ User selected – zone colours are selected when establishing the prescription map.

With Fieldware Link (v5.01 or later), users can import VRA jobs created in Fieldware Link, as well as export job data from the console, edit the included maps to create Target rate or Prescription maps, and transfer back to the console for job use.

NOTE: Advanced Job Mode is required for variable rate applications.

See Options (Job mode) in the System Setup chapter.

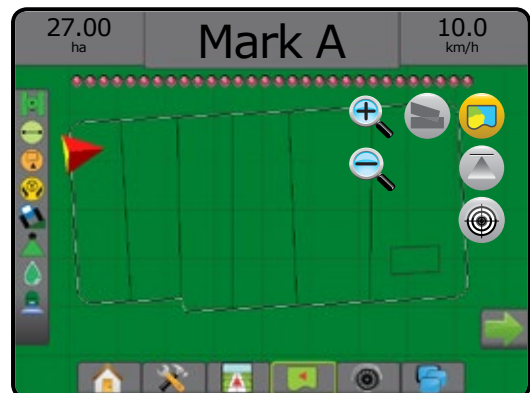

Aeros 9040 field computer

Application and Target Rate Maps

Application Map  shows how much product has been applied and where, using colour to indicate level in proportion to preset or automatically set maximum and minimum levels

Target Rate Map  shows the application rate that the rate controller attempted to achieve at each location

NOTE: Application map and Target Rate map cannot be selected simultaneously.

Application Map

- Coverage area – illustrates applied area:
 - ◀ User selected – applied areas show coloured bars relative to selected colour range and map selection.

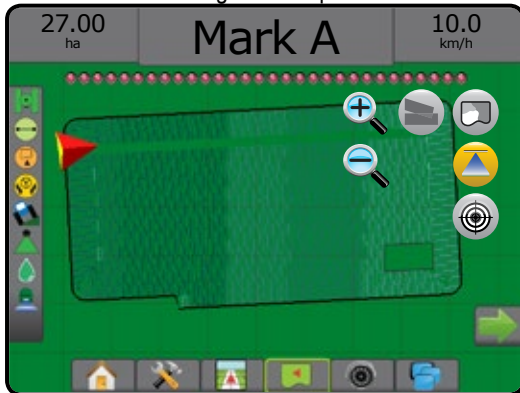

Target Rate Map

- Coverage area – illustrates applied area:
 - ◀ User selected – applied areas show coloured bars relative to selected colour range and map selection.

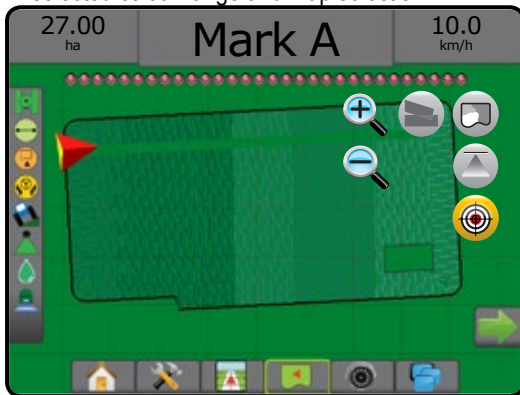

Target Rates

Preset target application rates define target rates of product being applied per hectare/acre. These settings will set the same for all active jobs.

Target rates are established on the ISOBUS ECU using the ISOBUS UT. The current Target rate is selected and boosted using the ISOBUS Operation screen on the UT. Boosting can also be controlled using the Vehicle view screen

- Up to five (5) target rates can be established

Colour Range Selection

Product options configure maximum/minimum rate limits and corresponding display colours for mapping.



- Press SYSTEM SETUP bottom tab .
- Press CONFIGURATION side tab .
- Press **Product**.
- Select:
 - ▶ Colour Range – mode used to set the rate for Maximum rate colour and Minimum rate colour.
 - ◀ Automatic – maximum and minimum will be determined by actual applied rate values or target rate values
 - ◀ Manual – maximum and minimum limits will be set to those set in Applied rate mapping upper limit and Applied rate mapping lower limit options
 - ▶ Maximum Rate Colour – used to set the colour for the maximum rate. When in Manual Colour Range mode, this colour will be used for all rates above the Applied Rate Mapping Upper Limit
 - ▶ Minimum Rate Colour – used to set the colour for the minimum rate. When in Manual Colour Range mode, this colour will be used for all rates below the Applied Rate Mapping Lower Limit

Figure 19: Product Options



INFORMATION ON GUIDANCE MODES

On screen guidance

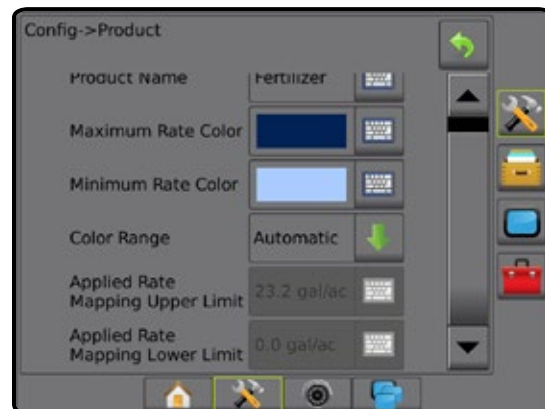
- Guidelines
 - ◀ Orange – active guidance line
 - ◀ Black (multiple) – adjacent guidance lines
 - ◀ Black – exterior boundary line
 - ◀ Grey – interior boundary line
 - ◀ Blue – polygon boundary line
 - ◀ Black/white – prescription map zone boundary line
- Points – markers for established points
 - ◀ Red point – Return to Point
 - ◀ Blue point – Mark A
 - ◀ Green point – Mark B
- Horizon compass – general heading can be displayed on horizon (when zoomed in)
- Coverage area – illustrates applied area and overlap:
 - ◀ Blue – one application
 - ◀ Red – two or more applications
 - ◀ User selected – Application map and Target rate map applied areas show coloured bars relative to selected colour range and map selection.
- Sections
 - ◀ Empty boxes – inactive sections
 - ◀ White boxes – active sections

Vehicle View



Vehicle View creates a computer-generated image of the vehicle position displayed in the application area. From this screen all setup, boundary, polygon, mapping, application and navigation options can be accessed via the options tabs on the right side of the screen.

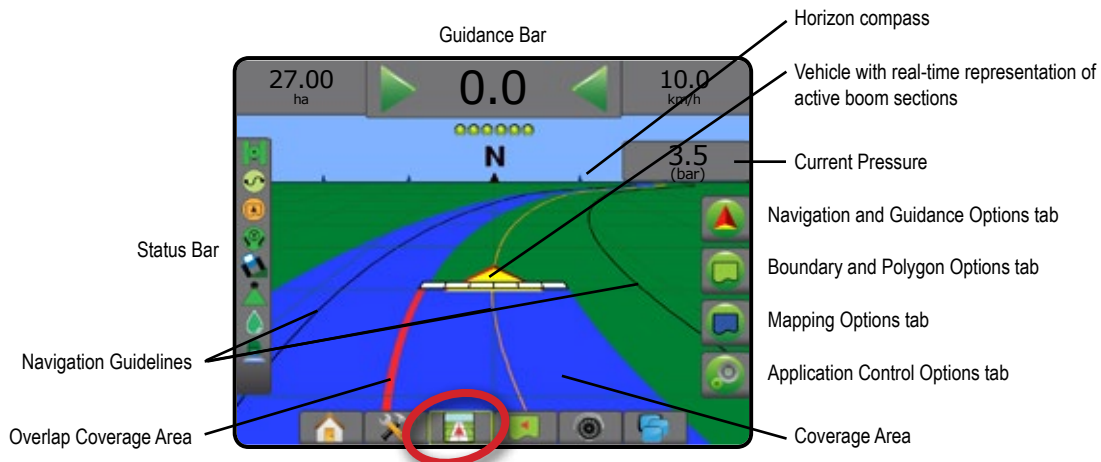

Field View



Field View creates a computer-generated image of the vehicle position and application area from an aerial perspective. From this screen, all setup, boundary, polygon and navigation options, as well as Pan mode and mapping options, can be accessed via the option tabs on the right side of the screen.

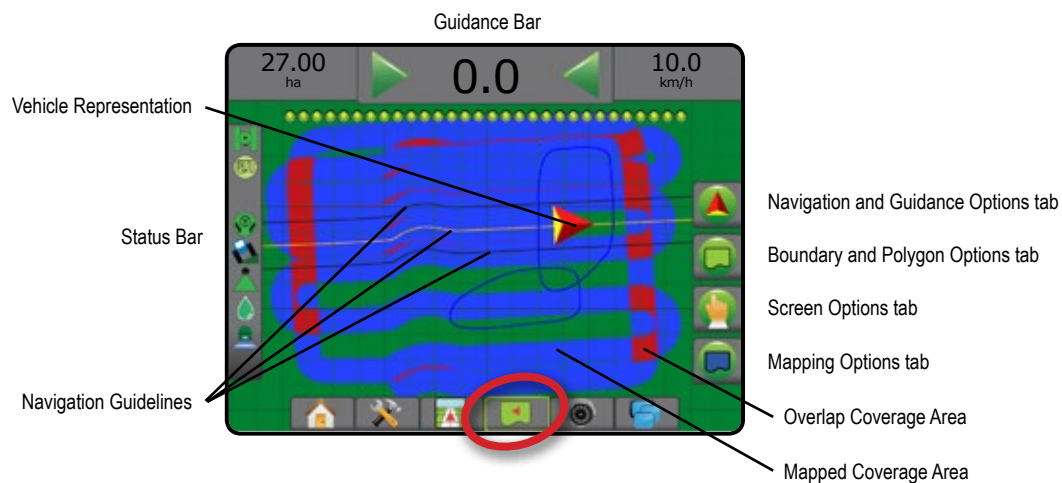

Aeros 9040 field computer

RealView Guidance





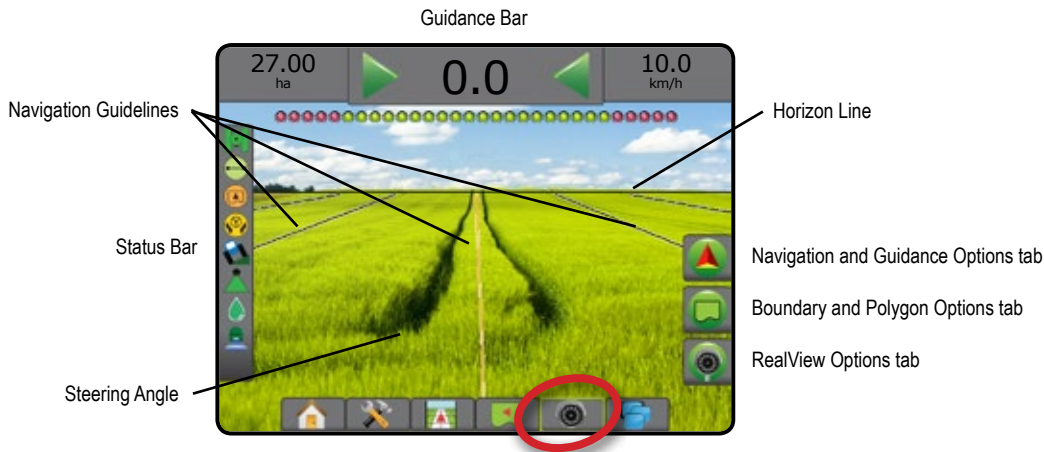

RealView guidance allows live video input to be displayed instead of a computer-generated image. From this screen all setup, boundary, polygon and navigation options can be accessed via the tabs on the right side of the screen. To adjust the camera view [reverse, upside down], go to Setup-> Configuration-> Video.

- ▶ Single Camera – a single camera is directly attached to the console
- ▶ Video Selection Module – if a Video Selection Module (VSM) is installed on the system, two (2) video options are available:
 - One camera view – one of up to eight camera inputs can be selected to change the view of the video input.
 - Split camera view – one of two sets of four camera inputs (A/B/C/D or E/F/G/H) can be selected to divide the screen into four separate video feeds.

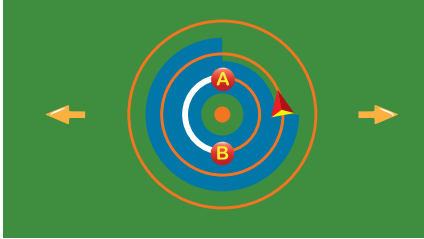

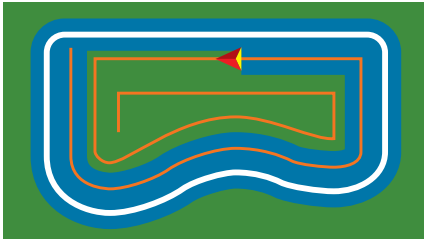
GUIDANCE MODES

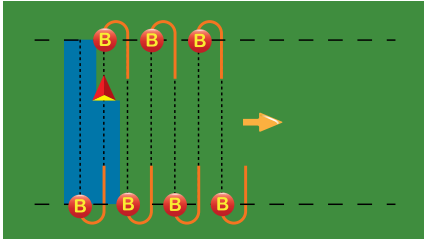
	<h3>Straight AB Guidance</h3> <p>Straight AB guidance provides straight-line guidance based on A and B reference points. The original A and B points are used to calculate all other parallel guidelines.</p> <p><i>NOTE: Offset to adjacent guidelines will be calculated using the guidance width: see "Configuration-> Mapping and guidance" in the System setup chapter.</i></p>	
	<h3>Curved AB Guidance</h3> <p>Curved AB guidance provides guidance along curved lines based on an initial AB reference line. This initial baseline is used to calculate all other guidelines.</p> <p><i>NOTE: Curved guidance is recommended not to exceed 30° within the AB guideline.</i></p> <p><i>Offset to adjacent guidelines will be calculated using the guidance width: see "Configuration-> Mapping and guidance" in the System setup chapter.</i></p> <p><i>HINT: While working in a bounded area, the guidance pattern extending beyond the established AB points will be straight-line guidance.</i></p>	
	<h3>Adaptive Curve AB Guidance</h3> <p>Adaptive Curve guidance* provides guidance along a curved line based on an initial AB reference line where each adjacent guideline is drawn from the projected guidance width and heading.</p> <p><i>NOTE: Offset to adjacent guidelines will be calculated using the guidance width: see "Configuration-> Mapping and guidance" in the System setup chapter.</i></p>	

	<h3>Circle Pivot Guidance</h3> <p>Circle Pivot guidance provides guidance around a central location that radiates inward or outward based on an initial AB reference line. This initial baseline is used to calculate all other guidelines.</p> <p>It is used for product application in a centre pivot field while being guided along a circular guideline that matches a centre pivot irrigation system radius.</p> <p><i>NOTE: Offset to adjacent guidelines will be calculated using the guidance width: see "Configuration-> Mapping and guidance" in the System setup chapter.</i></p>	
	<h3>Last Pass Guidance</h3> <p>Last Pass guidance* offers true last-pass navigation. The console will automatically detect the nearest applied area and establish parallel guidelines based on that area.</p> <p><i>NOTE: If a boundary is established but no application occurred during the boundary process, guidance will not initiate.</i></p>	
	<h3>NextRow Guidance</h3> <p>NextRow guidance* indicates where the NextRow is located, and provides guidance at row ends to the next adjacent row. When the operator marks the end of the row and begins turning to the next row, a Straight AB guidance line is provided in the next row. When the vehicle is in the NextRow, guidance is turned off.</p> <p><i>NOTE: Offset to NextRow will be calculated using the guidance width: see "Configuration-> Mapping and guidance" in the System setup chapter.</i></p> <p><i>The NextRow Guidance does not support skipping rows.</i></p>	
	<h3>No Guidance</h3> <p>No guidance* turns off guidance.</p> <p><i>NOTE: No guidance mode does not delete established guide lines or points from the console. To delete established/saved data from the console, see "Data management" in the System setup chapter.</i></p>	

*Guidance options may not be available depending on assisted/automatic steering system installed.

Adjacent rows may be skipped in Straight AB guidance, Curved AB guidance, Adaptive Curve guidance and Circle Pivot guidance. Last Pass guidance and NextRow guidance do not support skipping adjacent rows.

SCREENS OPTIONS

Guidance and navigation can be accessed from the Vehicle View screen, Field View screen, or RealView screen.







- Navigation and Guidance Options tab  – on any guidance screen, displays navigation options including guidance modes, guideline options, return to point options, refresh GNSS, BoomPilot toggle, curved lookahead toggle and Nozzle Flow Monitor reset.
- Boundary and Polygon Options tab  – on any guidance screen, displays exterior boundary, interior boundary and polygon options.
- Mapping Options tab  – on Vehicle View or Field View guidance screens, displays polygon maps, coverage maps and application maps.
- Application Options tab  – on Vehicle View guidance screen, displays ISOBUS Sprayer application options.
- Screen Options tab  – on Field View guidance screen, displays zoom and pan options.
- RealView Options tab  – on RealView guidance screen, displays camera setup and guidance over video options.

Figure 20: Guidance Screen Options







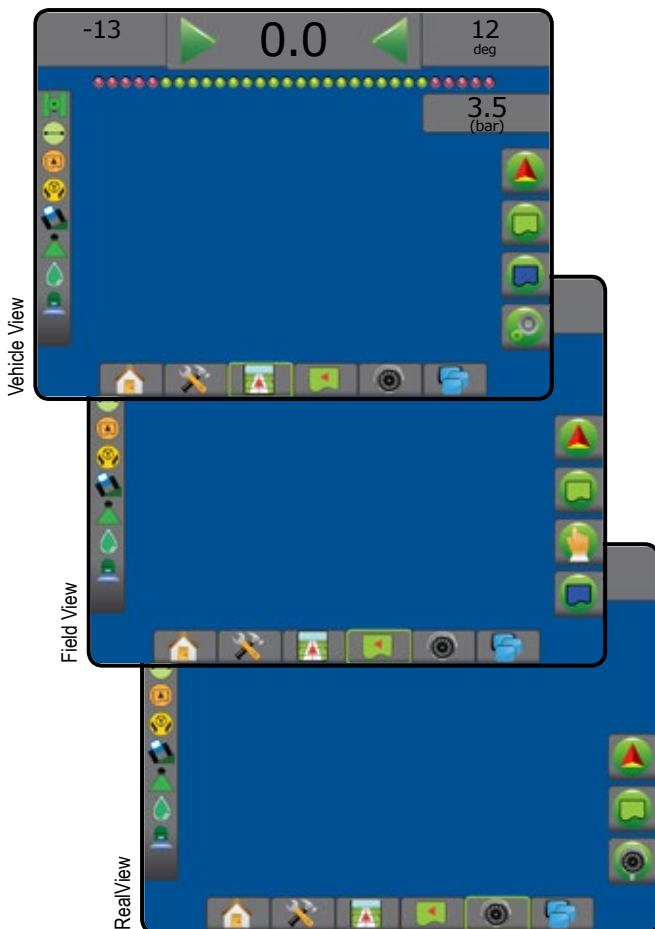
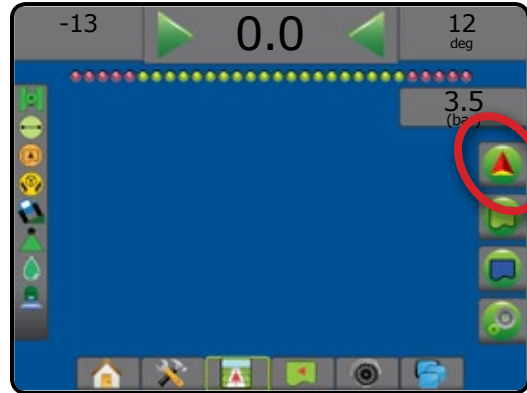









Navigation and Guidance Options

On any guidance screen, displays navigation options including guidance modes, guideline options, return to point options, refresh GNSS, BoomPilot toggle, curved lookahead toggle and Nozzle Flow Monitor reset.



Guidance Mode

	Guidance Mode – access to guidance mode options
	No guidance – turns off guidance
	Straight AB guidance  – provides straight-line guidance based on A and B reference points
	Curved AB guidance  – provides guidance along curved lines based on an initial AB reference line
	Circle Pivot guidance  – provides guidance around a central location that radiates inward or outward based on an initial AB reference line
	Last Pass guidance  – offers true last-pass navigation
	NextRow guidance  – indicates where the NextRow is located, and provides guidance at row ends to the next adjacent row
	Adaptive Curve guidance  – provides guidance along a curved line based on an initial AB reference line where each adjacent guideline is drawn from the projected guidance width and heading

BoomPilot

	Toggles the Automatic Section Control (ASC) on or off. Greyed = GNSS is unavailable.
---	--

Curved Lookahead

	Indicates where the current steering will take the vehicle using a 'pointer' as guidance.
---	---

Guidelines	
	Mark A – marks the first point of the guideline.
	Mark B – marks the end point of the guideline. Greyed = minimum distance has not been travelled.
	Cancel mark A – cancels the Mark A process. Reverts to previous AB guideline (when established).
	NextRow mark B – marks the end point of the row.
	Azimuth Degree – establishes a straight guideline measured by degrees clockwise from a north-south baseline. North = 0, East = 90, South = 180, West = 270.
	A+ Nudge – shifts the existing guideline to the vehicle's current position.
	Next Straight Guideline – shows the next straight AB or Azimuth Degree guideline saved in the current job.
	Next Curved AB Guideline – shows the next Curved AB guideline saved in the current job.
	Next Circle Pivot Guideline – shows the next Circle Pivot AB guideline saved in the current job.
	Next Adaptive Curve Guideline – shows the next Adaptive Curve AB guideline saved in the current job.

Return to Point	
	Mark point – establishes a point at the vehicle location. Greyed = GNSS is unavailable.
	Return to Point guidance – provides distance and guidance back to an established point.
	Delete point – deletes the Marked Point.
	Cancel guidance – hides the distance and guidance back to the marked point.

Nozzle fault reset	
	Clears any nozzle fault indications.

Refresh GNSS position	
	Resets the ClearPath filter in the OEMStar receiver.

Boundary and Polygon Options

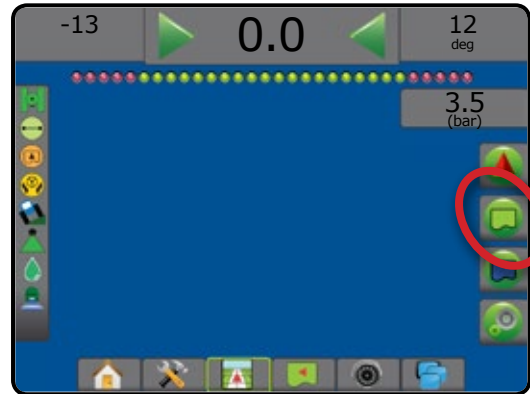

On any guidance screen, displays exterior boundary, interior boundary and polygon options.















Exterior boundaries	
	Mark exterior boundary – establishes application area and determines no-apply zones. While creating an exterior boundary, the boundary line will be to the exterior of the outer-most section. Greyed = GNSS is unavailable.
	Cancel exterior boundary – cancels mark exterior boundary process
	Finish exterior boundary – finalizes current mark exterior boundary process. Boundaries can also be closed by travelling to within a swath width of the starting point.
	Pause exterior boundary – pauses the mark exterior boundary process
	Resume exterior boundary – resumes the mark exterior boundary process
	Delete last marked boundary – deletes the last marked boundary (interior or exterior) from the current job. Press again to remove additional boundaries in order from last to first created

Interior boundaries	
	Mark interior boundary – establishes application area and determines no-apply zones. While creating an interior boundary, the boundary line will be to the interior of the inner-most section. Greyed = GNSS is unavailable.
	Cancel interior boundary – cancels current mark interior boundary process
	Finish interior boundary – finalizes current mark interior boundary process. Boundaries can also be closed by travelling to within a swath width of the starting point

Aeros 9040 field computer

	Pause interior boundary – pauses the mark interior boundary process
	Resume interior boundary – resumes the mark interior boundary process
	Delete last marked boundary – deletes the last marked boundary (interior or exterior) from the current job. Press again to remove additional boundaries in order from last to first created

Polygons	
	Mark polygon – establishes mapping areas. Greyed = GNSS is unavailable.
	Cancel polygon – cancels current mark polygon process
	Finish polygon – finalizes current mark polygon process
	Pause polygon – pauses the mark polygon process
	Resume polygon – resumes the mark polygon process
	Delete last marked polygon – deletes the last marked polygon from the current job. Press again to remove additional polygons in order from last to first created

	Coverage map – shows areas covered by the implement, regardless of whether product was applied.
	Polygon map – shows all mapped polygons
	Prescription map – shows pre-loaded map that provides information to the rate controller for use in applying product
	Application map – shows where product has been applied, using colour to indicate level in proportion to preset maximum and minimum levels
	Target rate map – shows the application rate that the rate controller will attempt to achieve
	Vehicle View – icons adjust the vehicle's view or perspective to the horizon from Vehicle View to bird's-eye view.
	Field View – icons increase/decrease the area displayed on the screen.

Mapping Options

On Vehicle View or Field View guidance screens, displays polygon maps, coverage maps and application maps.

NOTE: Options are available only when a rate controller is on the system or a polygon has been established.

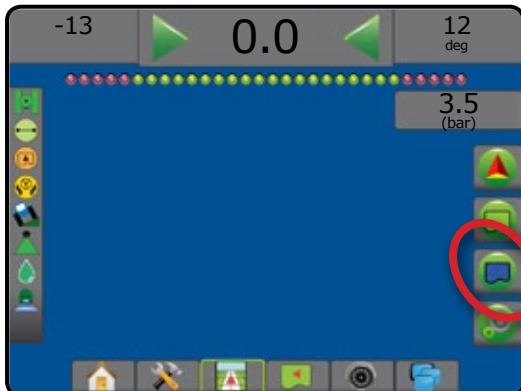



Application Control Options

On Vehicle View guidance screen, displays ISOBUS Sprayer application options.

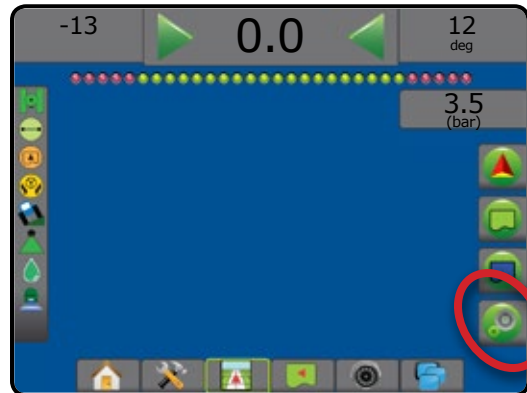
NOTE: Options are available only when a ISOBUS Sprayer rate controller is on the system.



	Target rate percentage increase – establishes the required boost percentage step increase
	Target rate percentage decrease – establishes the required boost percentage step decrease
	Percentage boost and reset – shows current boost percentage step and when pressed, zeros the boost percentage step



Screen Options

On Field View guidance screen, displays zoom and pan options.

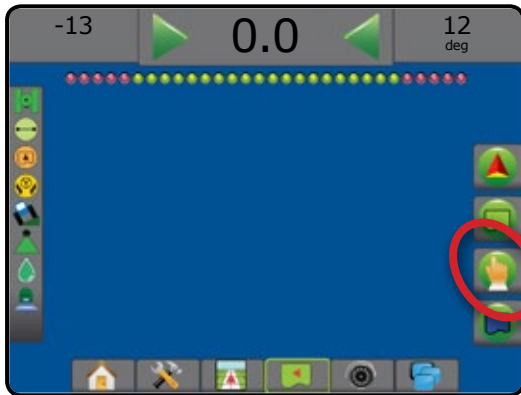

Zoom In/Out



Vehicle View – icons adjust the vehicle's view or perspective to the horizon from Vehicle View to bird's-eye view.



Field View – icons increase/decrease the area displayed on the screen.



Pan



Arrows – move the displayed map area in the corresponding direction without moving the vehicle.



World View – extends the screen view to the widest area available.



RealView Guidance Options

On RealView guidance screen, displays camera setup and guidance over video options.

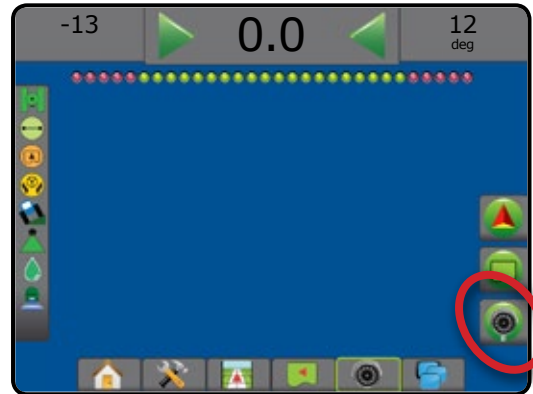

Video camera select – selects one of up to eight camera views if a Video Selection Module (VSM) is attached.



Split camera view – selects one of two sets of four camera inputs (A/B/C/D or E/F/G/H) to divide the screen into four separate video feeds.



Guidance Over Video setup – access to turn on Guidance Over Video or Steering angle and adjust guidelines.



Guidance Over Video – places three-dimensional guidelines over the video feed for navigational assistance.



Steering angle – displays the direction in which the steering wheel needs to be adjusted.



Up & down icons – used to adjust the guidance lines and horizon line to match the camera's view.



Camera image capture – saves a still photo of the current view on the screen to a USB drive.

GUIDANCE BAR

The Guidance bar keeps you informed of your choice of selectable information, navigation activity, and section status.

Navigation Activity & Boom Status

GNSS Status – displays “No GNSS” when GNSS is unavailable, or “Slow GNSS” when GNSS is receiving GGA data at less than 5Hz

Cross Track Error – displays the distance from your desired guideline.

The distance around the guideline that is perceived as zero error can be adjusted using Configuration-> Guidance-> Guidance Sensitivity.

To change the format in which the distance is displayed:

1. Press the Navigation Activity box on the guidance bar.
2. Select the measurement format.

Current Activity – displays activities such as mark an A or B point, approaching the end of a row, indicating to turn now, and distance to return to a marked point

Section Status – one dot is displayed for each section programmed: a green dot indicates the section is active, and a red dot indicates the section is not active



Selectable Information

Speed – displays the current speed of travel

Heading – displays the course of travel based clockwise from a true north baseline. North = 0°, East = 90°, South = 180°, West = 270°.

Total Applied Area – displays the total accumulated area that has had product applied, including double-coverage areas

Application Time – displays the total time application is active during the current job

Time – displays the current time based on the selected time zone

Swath Number – displays the current swath number in reference to the initial AB guidance line, facing in the direction from A to B. Number will be positive when the vehicle is to the right of the AB baseline, or negative when the vehicle is to the left of the AB baseline.

System Pressure – displays the current system pressure (available only when an Input/Output Module or Dual Control Module with an active pressure sensor is on the system)

Droplet Size – displays the current nozzle droplet size (available only when an Input/Output Module or Dual Control Module with an active pressure sensor is on the system)

Actual Application Rate – displays the current application rate (available only when a rate controller is on the system)

Target Application Rate – displays the target application rate (available only when a rate controller is on the system)

Volume/Product Applied – displays the volume or weight of product applied (available only when a rate controller is on the system)

Tank/Bin Amount Remaining – displays the volume or weight of product remaining in the tank/bin (available only when a rate controller is on the system)



STATUS BAR

The Status bar provides information on GNSS status, guidance mode, arable land area, assisted/auto steering engagement, tilt correction, implement control status, droplet/pressure status, and nozzle flow status.

When an icon is pressed, the related status information is displayed.

Figure 21: Status Bar

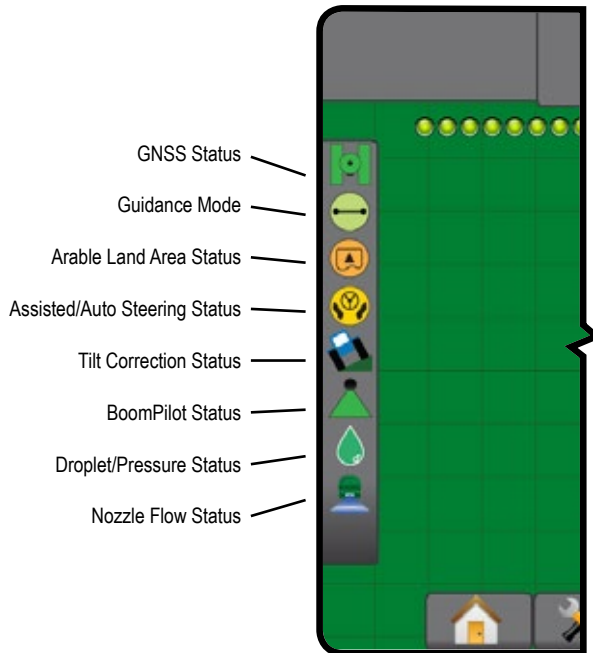

GNSS Status

- Green = GPS, GLONASS, or SBAS (with or without DGPS Required)
- Yellow = GPS only
- Red = no GNSS
- Orange = Glide/ClearPath

Guidance Mode

- No icon = no guidance
- Straight AB Guidance
- Curved AB Guidance
- Circle Pivot Guidance
- Last Pass Guidance
- Nextrow Guidance
- Adaptive Curve Guidance

Arable Land Area Status

- Outside Arable Land Area = traveling outside arable land area
- Inside Arable Land Area = traveling inside arable land area
- No icon = no boundary established (exterior or interior)

Assisted/Auto Steering Status

- Green = engaged, actively steering
- Yellow = enabled, all conditions have been met to allow for assisted/auto steering
- Red = disabled, all conditions have not been met to allow for assisted/auto steering
- No icon = no assisted/auto steering system installed

Tilt Correction Status

- Coloured = engaged, actively applying tilt correction
- Red = disabled
- No icon = no tilt gyro module installed on system, or tilt is associated with assisted/auto steering system

BoomPilot Status

- Green = automatic
- Yellow = all on
- Red = off/manual
- No icon = single section (no SmartCable or SDM installed on system)

Droplet/Pressure Status

- Coloured = engaged. The colour of the droplet is directly associated with the current droplet size. Colour options include:
- Crossed out = disabled
- No icon = no Pressure sensor interface kit installed, no pressure sensor monitor on the DCM

Nozzle Flow Status

- Green = nozzle flow system calibrated with no nozzle errors
- Red = nozzle flow imbalance: flow is higher or lower than the nozzle alarm threshold
- No icon = no Nozzle Flow Monitor hardware detected

GUIDANCE FEATURES DETAILS

A+ Nudge Feature

A+ The A+ Nudge feature allows the current guideline to be shifted to the vehicle's current location.

NOTE: Available only when in Straight AB or Curved AB guidance.

To adjust the guideline:

1. Press NAVIGATION AND GUIDANCE OPTIONS tab  to display navigation options.
2. Press A+ NUDGE icon **A+**.

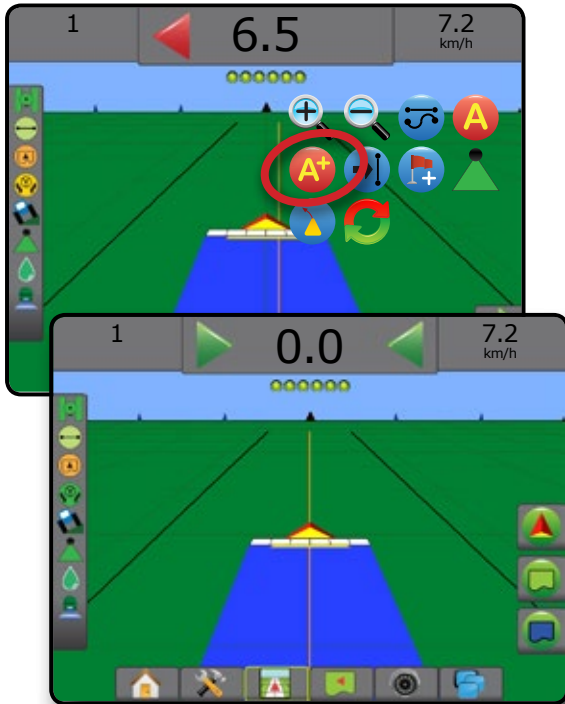

Azimuth Degree

A↑ An azimuth is defined as a horizontal angle measured clockwise from a true north baseline. When using an azimuth, the point from which the azimuth originates is the centre of an imaginary circle. North = 0°, East = 90°, South = 180°, West = 270°.

Azimuth Degree guidance projects a guideline between the current vehicle position (the A point) and a B point set 100 metres away along the entered azimuth heading.

To establish an Azimuth Degree guideline:

1. Press NAVIGATION AND GUIDANCE OPTIONS tab  to display navigation options.
2. Press AZIMUTH icon **A↑** to enter azimuth degree.
3. Use the entry screen to establish the azimuth degree.
4. "Would you like to name this guideline?"

Press:

- ▶ Yes – to enter a name and save the guideline
- ▶ No – to automatically generate a name

The console will begin providing navigation information.

To establish additional azimuth guidelines, follow the same steps as the initial azimuth guideline.



Return to Point



Return to Point provides guidance back to an established point in Vehicle View and Field View. In Vehicle View an arrow directs the vehicle back to the established point. In Field View only the point is displayed.

A return point is job-specific, and will remain active in the active job until canceled.

NOTE: Return to Point guidance may not be available depending on assisted/automatic steering system installed.

Marking a Return Point

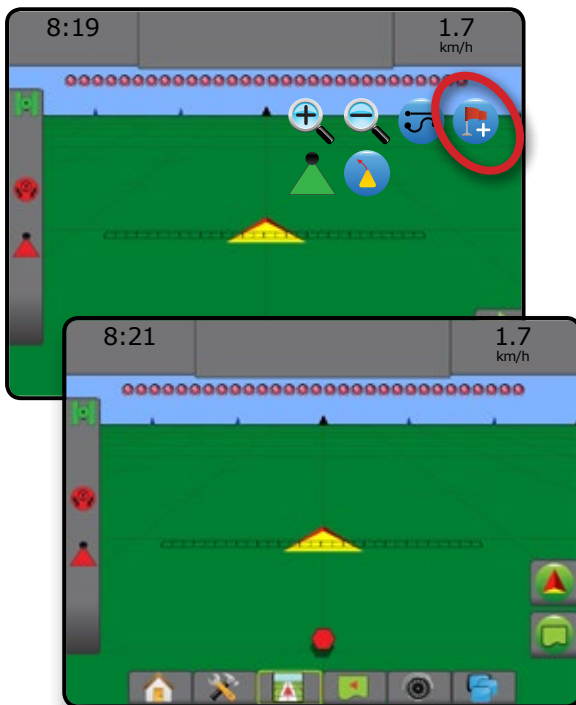

To mark a return point:

1. Drive to the desired location of return point .
2. Press NAVIGATION AND GUIDANCE OPTIONS tab  to display navigation options.
3. Press ADD POINT icon .



Delete the Return Point

To delete the established return point:



1. Press NAVIGATION AND GUIDANCE OPTIONS tab  to display navigation options.
2. Press DELETE POINT icon .

Delete Point icon is not available while return to point guidance is active.



Guidance to a Return Point

To show distance and guidance to the established return point:

1. Press NAVIGATION AND GUIDANCE OPTIONS tab  to display navigation options.
2. Press the RETURN TO POINT GUIDANCE icon .

The console will begin providing the distance information on the Guidance bar from the vehicle to the established point.

Use CANCEL RETURN TO POINT GUIDANCE icon  to hide distance and guidance to the established point.



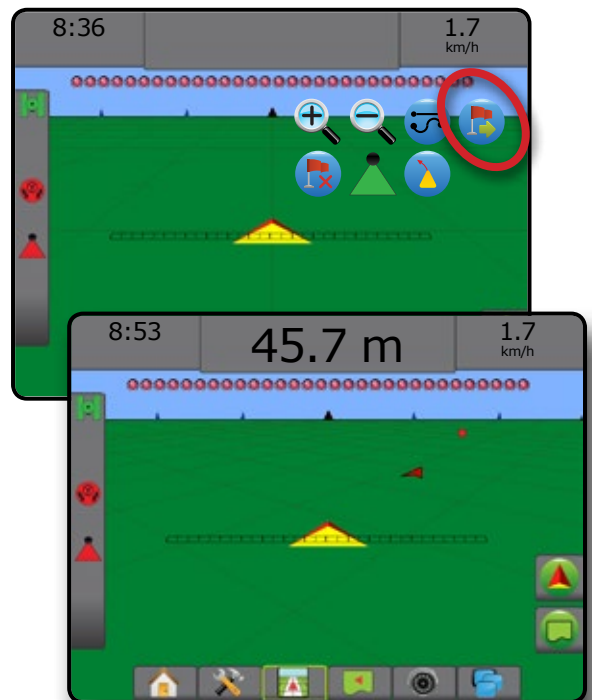

Guidance cannot be calculated when “?” appears in the guidance bar.



Aeros 9040 field computer



Next Guideline Feature

If more than one guideline is saved, the Next Guideline Feature will become available. By pressing the Next guideline option, the vehicle will be directed to the next guideline saved in the console.

- Next Straight Guideline  – shows the next straight AB or Azimuth Degree guideline saved in the current job.
- Next Curved AB Guideline  – shows the next Curved AB guideline saved in the current job.
- Next Circle Pivot Guideline  – shows the next Circle Pivot AB guideline saved in the current job.
- Next Adaptive Curve Guideline  – shows the next Adaptive Curve AB guideline saved in the current job.

NOTE: Offset to adjacent guidelines will be calculated using the guidance width. See “Configuration->Mapping and guidance” in the System setup chapter.

To change to other available guidelines:

1. Press NAVIGATION AND GUIDANCE OPTIONS tab  to display navigation options.
2. Press NEXT GUIDELINE icon .

Toggle between all guidelines by pressing the NEXT GUIDELINE icon  again.

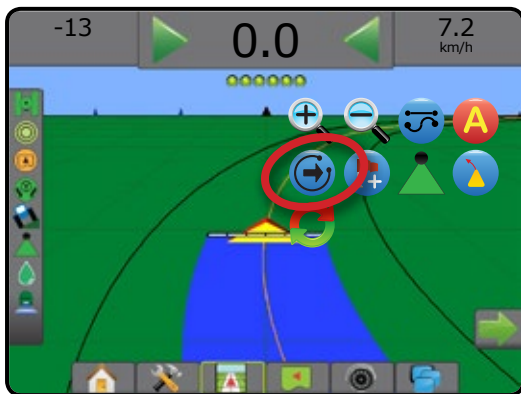

To view which guideline is active, press the Guidance mode icon on the Status bar.

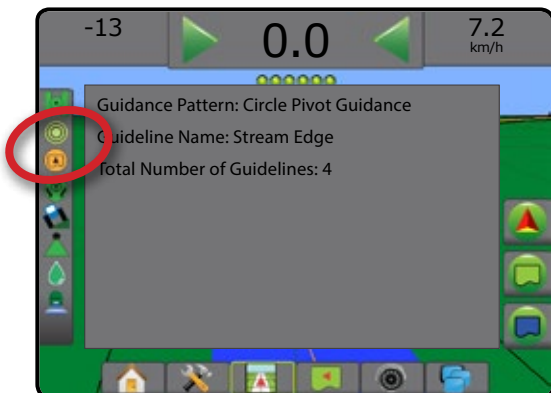



REFRESH GNSS POSITION

Refresh GNSS position resets the ClearPath filter in the OEMStar receiver in cases where the user has had the receiver running in close proximity to heavy tree cover and/or buildings. See “Configuration-> GNSS Receiver Configuration” to activate the Refresh GNSS position icon.

NOTE: Activating the refresh while in a job will cause a momentary interruption in the relay of GNSS data. This will most likely result in sections already on in automatic BoomPilot mode to go off for a short period of time.

The refresh should not be done during active application.

To refresh the GNSS position:

1. Press NAVIGATION AND GUIDANCE OPTIONS tab  to display navigation options.
2. Select Refresh GNSS POSITION icon .

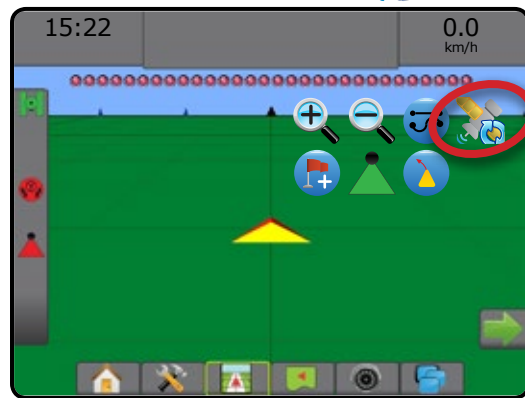

BOOMPILOT

Depending on if there is a section control system present and when present what kind of section control is being used as well as what options are enabled, there are multiple options for BoomPilot section control.

This section includes setup options for these configurations:

- ▶ No Section Control Module
 - Console only
 - With optional work on/off switch
- ▶ ISOBUS sprayer
 - Console and ECU only
 - With switchbox
 - With an ISOBUS Implement Status Module (ISO ISM)
- ▶ ISOBUS spreader
 - Console only
 - With optional spreader on/off switch

Figure 22: BoomPilot Icon and Status Bar Indicator



No Section Control Module

If a section control system is not present, manual section control will be available. An optional work on/off switch is used to turn the single section on or off. The BoomPilot icon is used to map application information on the guidance screens. Only one section width will be illustrated and the status bar will have no icon.



NOTE: If an ISOBUS controller, SmartCable, Section Driver Module (SDM), or Switch Function Module (SFM) is present, please refer to the following sections for more information.

NOTE: The BOOMPILOT icon is grey  when GNSS is unavailable.



Console Only

The BoomPilot icon is used to turn section application mapping on or off.

To set configuration settings:

1. Press SYSTEM SETUP bottom tab .
2. Press CONFIGURATION side tab .
3. Press **Implement**.
4. Set "BoomPilot icon" to **Enable**.



To switch application mapping off or on using the console:

1. Press NAVIGATION AND GUIDANCE OPTIONS tab  to display navigation options.
2. Press BOOMPILOT icon  to toggle the section on or off.

With Optional Work On/Off Switch

The Work On/Off Switch is used to turn section and associated application mapping on or off.

To set configuration settings:



1. Press SYSTEM SETUP bottom tab .
2. Press CONFIGURATION side tab .
3. Press **Implement**.
4. Set "BoomPilot icon" to **Disable**.

To switch section and associated application mapping off or on:

1. Turn Work On/Off Switch On/Off.

Aeros 9040 field computer

ISOBUS Sprayer



If an ISOBUS Electronic Control Unit (ECU) is present, the BoomPilot icon or an optional switchbox can be used to turn the boom on or off. The BoomPilot icon may also be used to set automatic section control to manual  or automatic . The number of section widths displayed will depend on the ISOBUS ECU configuration.

NOTE: The BOOMPILOT icon is grey  when GNSS is unavailable.

Console and ECU Only





All ISOBUS rate control configurations should be setup before starting BoomPilot. Automatic or manual regulation mode should not affect the following options.

To switch application off or on automatically:

1. Press NAVIGATION AND GUIDANCE OPTIONS tab  to display navigation options.
2. Press BOOMPILOT icon .
◀Automatic – status bar icon will change to green 

NOTE: Application can be manually controlled while in Automatic BoomPilot mode using the Start/stop key on the ISOBUS Operation screen.



To switch application off or on manually:

1. Press NAVIGATION AND GUIDANCE OPTIONS tab  to display navigation options.
2. Press BOOMPILOT icon .
◀Automatic – status bar icon will change to red 
3. Press ISOBUS UNIVERSAL TERMINAL bottom tab .
4. Go to the Operation screen
5. Use the START/STOP key .

With Switchbox

All ISOBUS rate control configurations should be setup before starting BoomPilot. Automatic or manual regulation mode should not affect the following options.



To switch application off or on automatically:

1. Switchbox master switch and section switches must be in the “On” positions.
2. Press NAVIGATION AND GUIDANCE OPTIONS tab  to display navigation options.
3. Press BOOMPILOT icon .
◀Automatic – status bar icon will change to green 

NOTE: Application can be manually controlled while in Automatic BoomPilot mode using the master switch or individual section switches.

Caution: With some versions of ISOBUS software, while in a previously applied area, manually changing a section switch will change BoomPilot to manual mode. Therefore, if a switch remained in the on position after exiting the applied area, it would remain off.



To switch application off or on manually:

1. Press NAVIGATION AND GUIDANCE OPTIONS tab  to display navigation options.
2. Press BOOMPILOT icon .
◀Manual – status bar icon will change to red 
3. Turn master switch or individual section switches On/Off.

With an ISOBUS Implement Status Module (ISO ISM)



All ISOBUS rate control configurations should be setup before starting BoomPilot. Regulation mode should be “Manual”.

To switch application off or on automatically:



1. Press NAVIGATION AND GUIDANCE OPTIONS tab  to display navigation options.
2. Press BOOMPILOT icon .
◀Automatic – status bar icon will change to green 

NOTE: Application can be manually controlled while in Automatic BoomPilot mode using the switches connected to the ISO ISM.

To switch application off or on manually:

1. Press NAVIGATION AND GUIDANCE OPTIONS tab  to display navigation options.
2. Press BOOMPILOT icon .
◀Automatic – status bar icon will change to red 
3. Turn master switch or individual section switches On/Off.

ISOBUS Spreader





If an ISOBUS Electronic Control Unit (ECU) is present, the BoomPilot icon or an optional remote master switch can be used to turn the application on or off. The BoomPilot icon may also be used to set automatic section control to manual  or automatic .

NOTE: The BOOMPILOT icon is grey  when GNSS is unavailable.

Console Only





All ISOBUS rate control configurations should be setup before starting BoomPilot. Regulation mode should be "Manual".

To switch application off or on automatically:

1. Press NAVIGATION AND GUIDANCE OPTIONS tab  to display navigation options.
2. Press BOOMPILOT icon .
◀Automatic – status bar icon will change to green 
3. Press the ISOBUS UNIVERSAL TERMINAL bottom tab .
4. Go to the Operation screen.
5. Use the START/STOP key .

NOTE: Application can be manually controlled while in Automatic BoomPilot mode using the Start/stop key on the ISOBUS Operation screen.

To switch application off or on manually:

1. Press NAVIGATION AND GUIDANCE OPTIONS tab  to display navigation options.
2. Press BOOMPILOT icon .
◀Automatic – status bar icon will change to red 
3. Press ISOBUS UNIVERSAL TERMINAL bottom tab .
4. Go to the Operation screen
5. Use the START/STOP key .

With Optional Spreader On/Off Switch

All ISOBUS rate control configurations should be setup before starting BoomPilot. Automatic or manual regulation mode should not affect the following options.

To set configuration settings:

1. Press the ISOBUS UNIVERSAL TERMINAL bottom tab .
2. Enable the Remote spread switch.

In areas where application is desired:

1. Turn Spreader on/off switch to the "on" position.





In areas where application is not desired:

1. Turn Spreader on/off switch to the "off" position.

ADDITIONAL IMPLEMENT OPTIONS

NOZZLE SELECTION

When the system includes a Pressure Sensor Interface Kit (PSIK), Nozzle selection is used to select the type of sprayer nozzle (series and capacity) for determining droplet size information.

1. Press CONFIGURATION side tab .
2. Press **Implement**.
 - ◀ Current nozzle section is shown in the information box
3. Press Nozzle selection NEXT PAGE arrow .
4. Select from:
 - ▶ Nozzle preset 1-5 – selects up to five (5) nozzles for quick recall, and selected the current nozzle for determining droplet size information
 - ▶ Current nozzle – displays the current nozzle
5. Press RETURN arrow  or CONFIGURATION side tab  to return to the main Configuration screen.

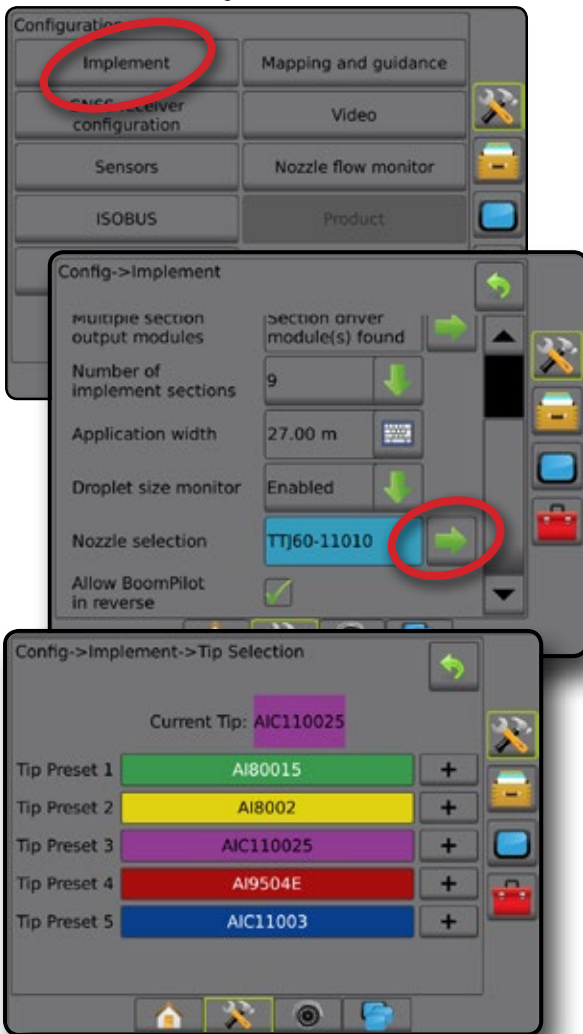

Preset

Nozzle presets allow saving of up to five nozzles for quick recall.

1. Press **+**.
2. Select a TeeJet nozzle series.
3. Select nozzle capacity.

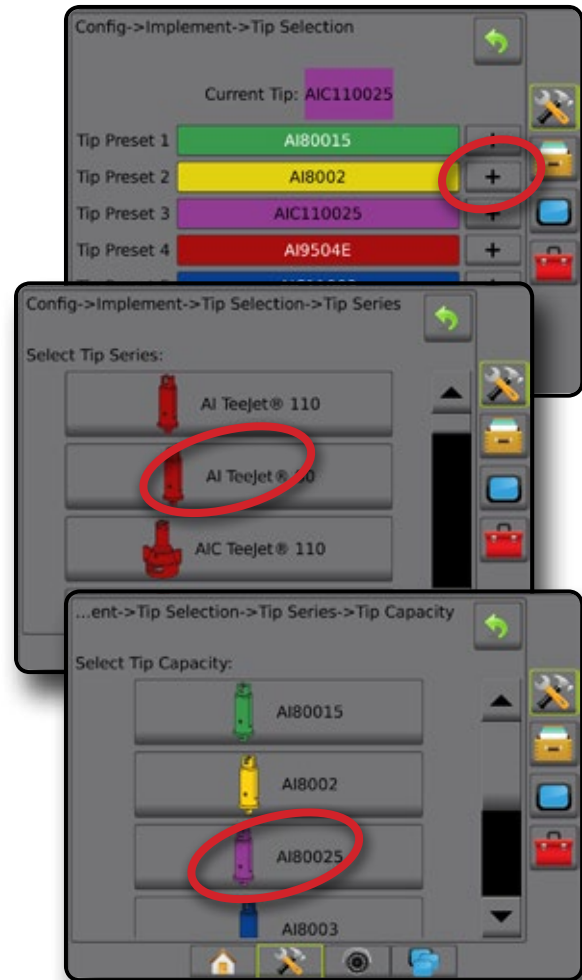

Nozzle Sizes and Associated Colours

Established Nozzle Capacities and Colours			
Size	Colour	Size	Colour
01	Orange	06	Grey
015	Green	08	White
02	Yellow	10	Light Blue
025	Purple	12	Telemagenta
03	Blue	15	Light Green
04	Red	20	Black
05	Brown	30	Beige

Current Nozzle

Current nozzle shows the active nozzle for determining current droplet size information. Nozzles must be preset to be available for current nozzle selection.

1. Press desired nozzle.

Selected nozzle will be shown:

- ◀ The information box on the Implement screen
- ◀ The Droplet/pressure status display from the status bar on the guidance screens

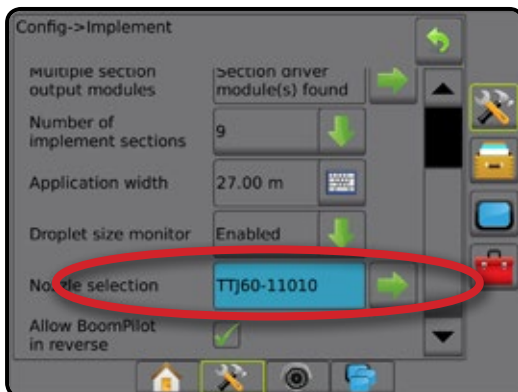
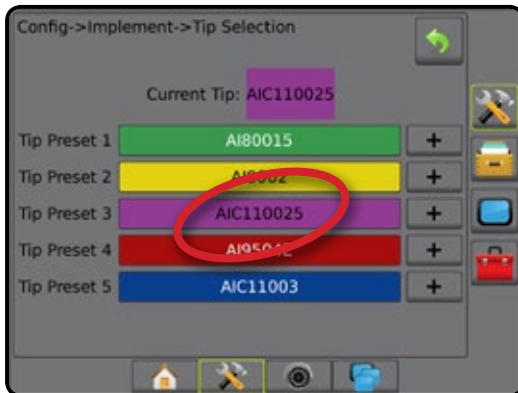



DROPLET SIZE MONITOR

When the system includes a Pressure Sensor Interface Kit (PSIK), Droplet Size Monitor can be enabled/disabled. The DSM then becomes available on the operation screens.

Setup

Enable/Disable DSM

1. Press CONFIGURATION side tab .
2. Press **Implement**.
3. Press **Droplet Size Monitor**.
4. Select if Droplet Size Monitor is enabled or disabled.
5. Press RETURN arrow  or CONFIGURATION side tab  to return to the main Configuration screen.

NOTE: When Droplet Size Monitor is disabled, the Droplet/pressure status is not available on the guidance screen status bar.

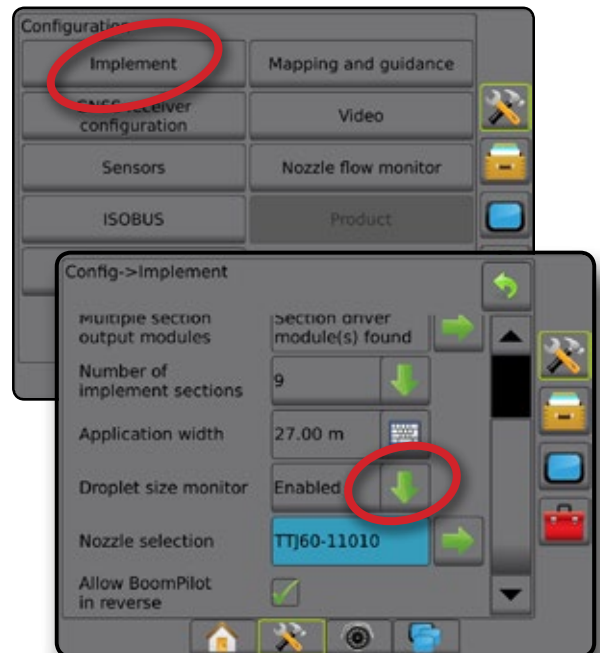

Nozzle Selection / Current Nozzle

To establish the nozzle presets and current nozzle, see “Nozzle Selection” in this chapter.

Input/Output Module Pressure Sensor

When a Pressure Sensor Interface Kit is present, Pressure sensor options are used to enter the sensor manufacturer's maximum pressure rating and set high and low user determined pressure alarms.



NOTE: For more information, see “Sensors” in the Setup chapter of this manual.

Aeros 9040 field computer

Operation







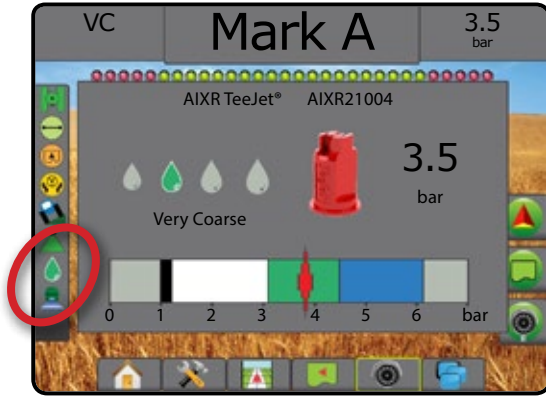



Status Bar

Droplet/pressure status displays information regarding the current status of the droplet size and system pressure.

1. Press DROPLET/PRESSURE STATUS icon  .
2. Press the screen anywhere to return to the guidance screen.



Droplet/Pressure Status

-  Coloured = engaged. The colour of the droplet is directly associated with the current droplet size. Colour options include:        
-  Crossed out = disabled
- No icon = no Pressure Sensor Interface Kit is installed on system

Droplet Size Chart

When choosing a spray nozzle that produces droplet sizes in one of the eight droplet size classification categories, always remember that a single nozzle can produce different droplet size classifications at different pressures. A nozzle might produce medium droplets at low pressures, while producing fine droplets as pressure is increased.

Category	Symbol	Colour Code
Extremely Fine	XF	Violet
Very Fine	VF	Red
Fine	F	Orange
Medium	M	Yellow
Coarse	C	Blue
Very Coarse	VC	Green
Extremely Coarse	XC	White
Ultra Coarse	UC	Black

Guidance Bar

The Guidance bar keeps you informed of your choice of selectable information including current system pressure and current droplet size.

1. Press SELECTABLE INFORMATION box.
2. Select from:
 - ▶ System Pressure – displays the current system pressure
 - ▶ Droplet Size – displays the current nozzle droplet size
3. Press outside the selection box to return to the guidance screen.

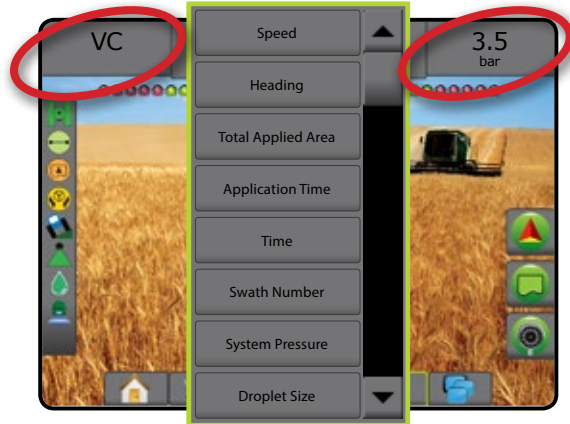

REVERSE SENSE

Reverse sense options are used when adding a Reverse Sense Module, SCM (Steering Control Module for FieldPilot IV) or SCM Pro (Steering Control Module Pro for FieldPilot Pro/UniPilot Pro) to any configuration. This allows for application mapping and control, and on-screen guidance when traveling in reverse.

1. Press CONFIGURATION side tab .
2. Press **Implement**.
3. In addition to standard options, select from:
 - ▶ Allow BoomPilot In Reverse – used to enable BoomPilot function while traveling in reverse
 - ▶ Reverse Signal Delay – used to set the delay when going from forward to reverse or reverse to forward, after which the vehicle icon on a navigation screen changes direction

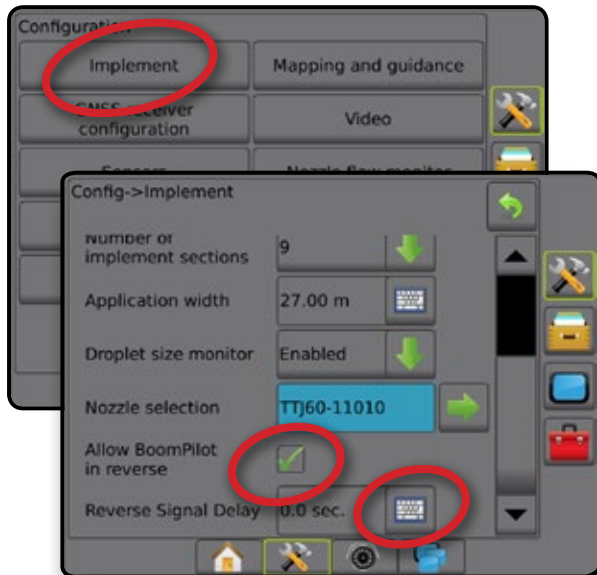

Reverse on Guidance Screens

While traveling in reverse, having BoomPilot in reverse active allows for product application, automatic section control, and mapping that is correct for reverse machine movement

- ◀ Speed on the Guidance bar will turn red while traveling in reverse

Figure 23: Traveling Forward

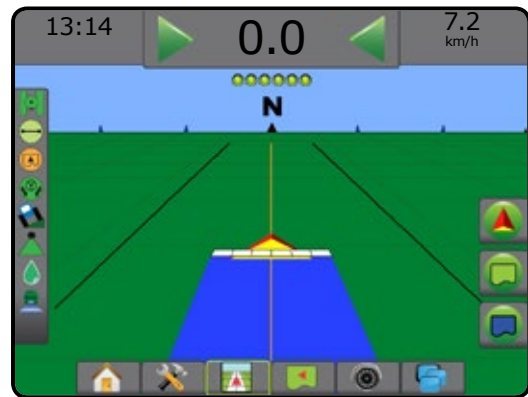
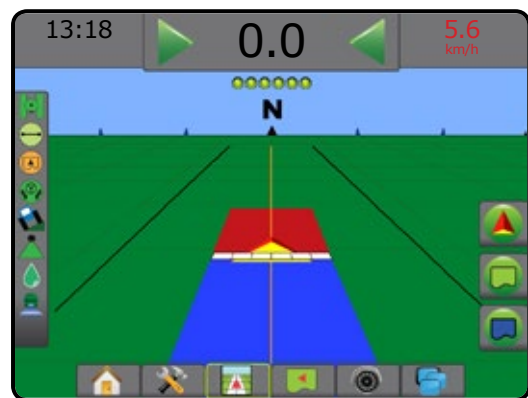

Figure 24: Traveling In Reverse



Availability with Different System Configurations

Automatic Section Control device on system	Device sensing reverse vehicle movement	BoomPilot in reverse feature available	BoomPilot in reverse can be turned on/off in menu using	Signal delay can be adjusted using
SDM or SFM	FieldPilot IV *	✓	Allow BoomPilot in reverse	Reverse signal delay
	Reverse Sense Module	✓	Allow BoomPilot in reverse	Reverse signal delay
	FieldPilot Pro / UniPilot Pro	✓	Allow BoomPilot in reverse	✗**
IC18 Sprayer or IC34 Sprayer	FieldPilot IV *	✓	Allow BoomPilot in reverse	Reverse signal delay
	Reverse Sense Module	✓	Allow BoomPilot in reverse	Reverse signal delay
	FieldPilot Pro / UniPilot Pro	✓	Allow BoomPilot in reverse	✗**

* Optional function that is hardware dependent.



** Controlled directly by the FieldPilot Pro / UniPilot Pro.

BOOMPILOT SECTION CONTROL

Depending on if there is a section control system present and when present what kind of section control is being used as well as what options are enabled, there are multiple options for BoomPilot section control. The following are the common configurations:

- ▶ No Section Control Module
 - Console only
 - With optional work on/off switch
- ▶ ISOBUS sprayer
 - Console and ECU only
 - With switchbox
 - With an ISOBUS Implement Status Module (ISO ISM)
- ▶ ISOBUS spreader
 - Console only
 - With optional spreader on/off switch

With any of these configurations, there are two section control options:

- Automatic Section Control  – using GNSS position and speed information, sections turn on or off as needed. The same section application information will be mapped on the guidance screens. Depending on configuration, automatic section control may be manually controlled using a switchbox, switch or the BoomPilot icon in the navigation and guidance options on the guidance screens.
- Manual Section Control  – using a switchbox or the BoomPilot icon in the navigation and guidance options, sections can be turned off or on manually as needed. Depending on the configuration, the same section application information may be mapped on the guidance screens.

The settings of BoomPilot Start mode and BoomPilot icon change how section control is handled on the guidance screens.

1. Press CONFIGURATION side tab .
2. Press **Implement**.
3. Select from:
 - ▶ BoomPilot start mode – used to establish the mode in which a job is started.
 - ◀ Automatic – automatic section control is enabled and section activation and/or on screen mapping will be controlled by GNSS and speed
 - ◀ Off – automatic section control is disabled but section activation and/or on screen mapping can be manually enabled by using a switchbox or the BoomPilot icon in the navigation and guidance options on the guidance screens



- ▶ BoomPilot Icon – used to establish if the BoomPilot icon is available in the navigation and guidance options on the guidance screens for manually controlling BoomPilot
 - ◀ Enable – BoomPilot Icon will be available in the navigation and guidance options on the guidance screens to control automatic section control
 - ◀ Disable – BoomPilot Icon will not be available in the navigation and guidance options
4. Press RETURN arrow  or CONFIGURATION side tab  to return to the main Configuration screen.

Figure 25: BoomPilot Options

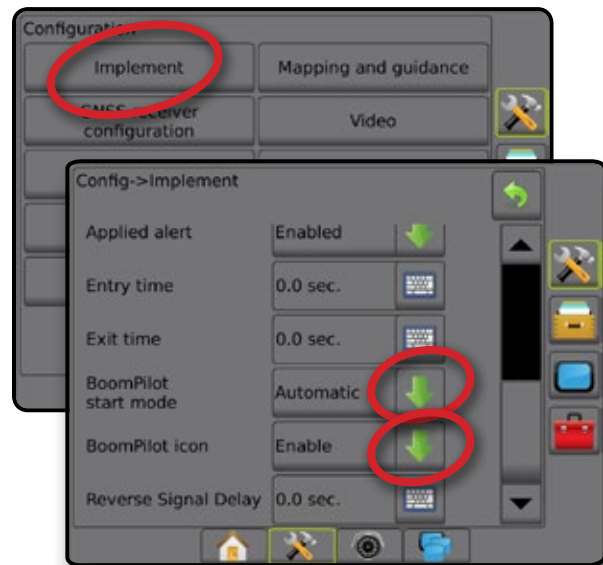

Figure 26: BoomPilot Icon on Guidance Screen



Availability With Different Hardware Systems

Hardware on system	BoomPilot start mode settable in Configuration->Implement	BoomPilot icon presence settable in Configuration->Implement	BoomPilot icon displayed in Navigation & guidance options
▶ No section control module			
• Console only	No	Yes	Yes
• With optional work on/off switch	No	Yes	Yes
▶ ISOBUS sprayer			
• Console and ECU only	Yes	No	Yes
• With switchbox	Yes	No	Yes
• With an ISO ISM	Yes	No	Yes
▶ ISOBUS spreader			
• Console only	Yes	No	Yes
• With optional spreader on/off switch	Yes	No	Yes
▶ With TeeJet SDM** or SFM*** + ASB**** or ISM*	No - BoomPilot mode is set on ASB or ISM	No	No
▶ With TeeJet SDM** or SFM***	Yes	No	Yes

* Requires Implement Status Module (ISM) v2.00 or later

** Requires Section Driver Module (SDM) v21.00 or later

*** Requires Switch Function Module (SFM) v21.00 or later

**** Requires Aeros Switchbox (ASB) v2.00 or later



NOZZLE FLOW MONITOR

When a Nozzle Flow Monitor Kit is present, Nozzle Flow Monitor options are used to configure flow limits and alarm behavior, and to run the nozzle flow balance process.

NOTE: For detailed setup instructions, refer to the supplemental Nozzle Flow Monitor (TFM) guide.

1. Press CONFIGURATION side tab .
2. Press **Nozzle Flow Monitor**.
3. Select from:
 - ▶ Nozzle Alarm Percentage – used to set the error reporting range for the nozzle sensors
 - ▶ Nozzle Alarm Delay – used to set the time the console will wait after an error has been encountered before sounding a nozzle alarm
 - ▶ Number of Sections – used to set the number of sections
 - ▶ Number of Nozzles per Section – used to enter the number of nozzles on the specified section
 - ▶ Nozzle Balance Percentage – used to set the range for balancing nozzle sensors

NOTE: The implement must be in a job and all sections must be on to start the nozzle balance process.

- ▶ Nozzle Flow Monitor Balance – used to start the nozzle flow balance process
4. Press RETURN arrow  or CONFIGURATION side tab  to return to the main Configuration screen.



ISOBUS SPRAYER OFFSETS

Connection point and implement offsets are used to enter the directions and distances from the centreline of the machine to the connection point and implement when Aeros has an ISOBUS Sprayer on the system.

Different machines have different options. The following machines are detailed in this manual. Contact your TeeJet dealer for information on your specific setup or if there are any questions.

- Self-propelled – front mount
- Self-propelled – rear mount
- Three point hitch – front mount
- Three point hitch – rear mount
- Trailed – always rear mount

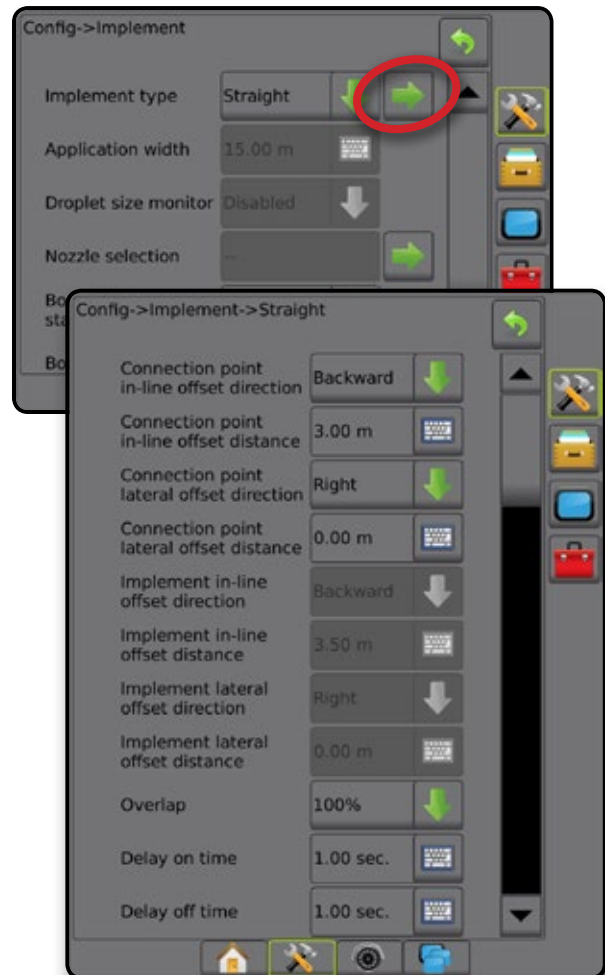

If using a self-propelled sprayer or spreader, use the GNSS offset adjustment calculation to calculate the implement Lateral Offset Distance adjustment. If using a pull behind or trailed implement, use the Implement offset adjustment calculation to calculate the Implement Lateral Offset Distance adjustment. See the “Implement Lateral Offset Distance Adjustment” section of this chapter for more details.

Figure 27: Straight Implement Type with ISOBUS Sprayer



Self-propelled

ISOBUS Sprayer Settings:

1. Press UNIVERSAL TERMINAL bottom tab .
2. From the Main setup screen , select **Machine**.
3. Select **OEM** then enter the access code as needed.
4. Select **Implement Geometry**:
5. Establish values for:
 - ▶ Connector type: **Selfpropelled - front** or **Selfpropelled - rear**
 - ▶ B=Section X-offset **4** – measured in parallel to the centreline of the machine, define the distance from the centre of the rear axle **B** to the implement

Aeros Settings:



1. Press SYSTEM SETUP bottom tab .
2. Press CONFIGURATION side tab .
3. Press **Implement**.
4. Select Implement type **Straight**.
5. Press Implement type NEXT PAGE arrow  to set up specific implement options.
6. Establish values for:
 - ▶ Connection Point In-line Offset Direction **1** – define the direction as **Forward** or **Backward** based on ISOBUS Sprayer connection type
 - ▶ Connection Point In-line Offset Distance **1** – measured in parallel to the centreline of the machine, define the distance from the GNSS antenna **A** to the centre of the rear axle **B**
 - ▶ Connection Point Lateral Offset Direction **2** – define the direction, either left or right, from the centreline of the machine to the centre of the rear axle **B** while facing in the machine's forward direction
 - ▶ Connection Point Lateral Offset Distance **2** – define the distance from the centreline of the machine to the centre of the rear axle **B**
 - ▶ Implement In-line Offset Direction **1** – same direction as Aeros Connection Point In-line Offset Direction
 - ▶ Implement In-line Offset Distance **5** – calculated based on Aeros Connection Point In-line Offset Distance **1** and ISOBUS Sprayer B=Section X-offset **4** entries
 - ▶ Front Mount – $4 - 1 = 5$
 - ▶ Rear Mount – $1 + 4 = 5$
 - ▶ Implement Lateral Offset Direction **2** – same direction as Aeros Connection Point Lateral Offset Direction
 - ▶ Implement Lateral Offset Distance **2** – same value as on Aeros Connection Point Lateral Offset Distance

Figure 28: Front Mount

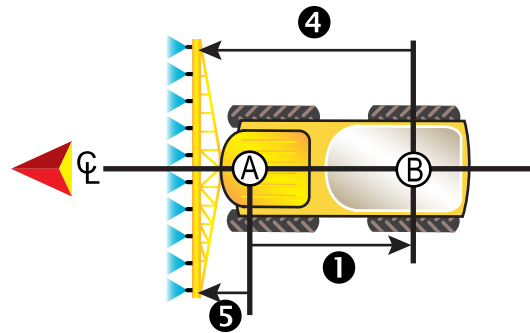
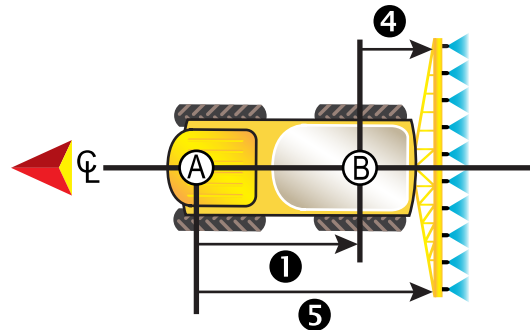



Figure 29: Rear Mount





- Ⓐ – Centre of the GNSS antenna
- Ⓑ – Centre of the rear axle
- ① – Connection Point In-line Offset Direction/Distance
- ② – Connection Point Lateral Offset Direction/Distance (not illustrated)
- ④ – B=Section X-offset distance
- ⑤ – Implement In-line Offset Direction/Distance

Three Point Hitch

ISOBUS Sprayer Settings:

1. Press UNIVERSAL TERMINAL bottom tab .
2. From the Main setup screen , select **Machine**.
3. Select **OEM** then enter the access code as needed.
4. Select **Implement Geometry**:
5. Establish values for:
 - ▶ Connector type: **3-point hitch - front** or **3-point hitch - rear**
 - ▶ B=Section X-offset **4** – measured in parallel to the centreline of the machine, define the distance from point **B** to the implement

Aeros Settings:

1. Press SYSTEM SETUP bottom tab .
2. Press CONFIGURATION side tab .
3. Press **Implement**.
4. Select Implement type **Straight**.
5. Press Implement type NEXT PAGE arrow  to set up specific implement options.

Aeros 9040 field computer

6. Establish values for:

- ▶ Connection Point In-line Offset Direction **1** – define the direction as **Forward** or **Backward** based on ISOBUS Sprayer connection type
- ▶ Connection Point In-line Offset Distance **1** – measured in parallel to the centreline of the machine, define the distance from the GNSS antenna (A) to point (B)
- ▶ Connection Point Lateral Offset Direction **2** – define the direction, either left or right, from the centreline of the machine to the centre of point (B) while facing in the machine's forward direction
- ▶ Connection Point Lateral Offset Distance **2** – define the distance from the centreline of the machine to point (B)
- ▶ Implement In-line Offset Direction **1** – same direction as Aeros Connection Point In-line Offset Direction
- ▶ Implement In-line Offset Distance **5** – calculated based on Aeros Connection Point In-line Offset Distance **1** and ISOBUS Sprayer B=Section X-offset **4** entries
 - ▶ **1 + 4 = 5**
- ▶ Implement Lateral Offset Direction **2** – same direction as Aeros Connection Point Lateral Offset Direction
- ▶ Implement Lateral Offset Distance **2** – same value as on Aeros Connection Point Lateral Offset Distance

Figure 30: Front Mount

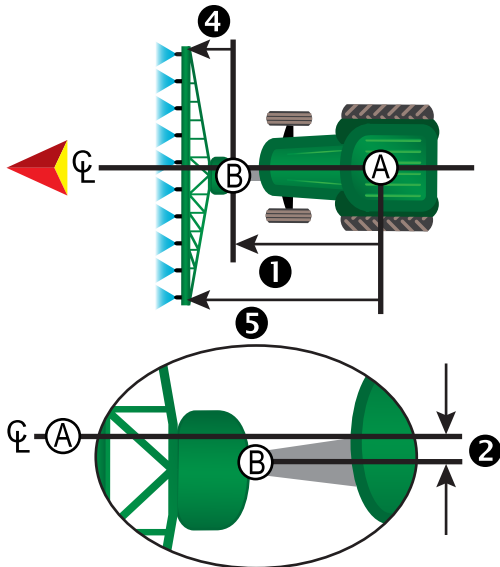
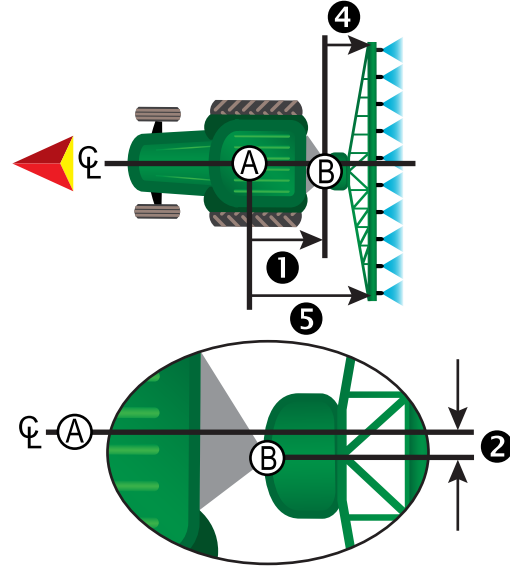



Figure 31: Rear Mount





- (A) – Centre of the GNSS antenna
- (B) – Connection Point
- 1** – Connection Point In-line Offset Direction/Distance
- 2** – Connection Point Lateral Offset Direction/Distance
- 4** – B=Section X-offset distance
- 5** – Implement In-line Offset Direction/Distance

Trailed

ISOBUS Sprayer Settings:



1. Press UNIVERSAL TERMINAL bottom tab .
2. From the Main setup screen , select **Machine**.
3. Select **OEM** then enter the access code as needed.
4. Select **Implement Geometry**:
5. Establish values for:
 - ▶ Connector type: **Trailed**
 - ▶ A=Connection X-offset **3** – measured in parallel to the centreline of the machine, define the distance from point (B) to the centre of the front axle of trailed implement (C)
 - ▶ B=Section X-offset **4** – measured in parallel to the centreline of the machine, define the distance from the centre of the front axle of trailed implement (C) to the implement

Aeros Settings:

1. Press SYSTEM SETUP bottom tab .
2. Press CONFIGURATION side tab .
3. Press **Implement**.
4. Select Implement type **Straight**.
5. Press Implement type NEXT PAGE arrow  to set up specific implement options.
6. Establish values for:

DATA MANAGEMENT

Data Management allows for transfer and management of job data, reporting of job data, changing of job mode, and transfer and management of machine settings.

1. Press SYSTEM SETUP bottom tab .
2. Press DATA MANAGEMENT side tab .
3. Select from:
 - ▶ Job Data – in advanced job mode, used to transfer job information (delete, import, export) and manage job information (create a new job, delete a job, or copy a job's guidelines, boundaries, applied data, prescription map and/or polygons to a new job)
 - ▶ Reports – used to create job reports and save them to a USB drive
 - ▶ Options – used to select simple job mode or advanced job mode
 - ▶ Machine Settings – used to transfer machine settings (delete, import, export) and manage machine setting (create a new machine setting, copy a machine setting, delete a machine setting, save the current machine setting to the selected file, or load the selected file's machine setting)

- ▶ Connection Point In-line Offset Direction **1** – define the direction as **Backward** based on ISOBUS Sprayer connection type
- ▶ Connection Point In-line Offset Distance **1** – measured in parallel to the centreline of the machine, define the distance from the GNSS antenna **A** to point **B**
- ▶ Connection Point Lateral Offset Direction **2** – define the direction, either left or right, from the centreline of the machine to point **B** while facing in the machine's forward direction
- ▶ Connection Point Lateral Offset Distance **2** – define the distance from the centreline of the machine to point **B**
- ▶ Implement In-line Offset Direction **1** – same direction as Aeros Connection Point In-line Offset Direction
- ▶ Implement In-line Offset Distance **5** – calculated based on Aeros Connection Point In-line Offset Distance **1**, ISOBUS Sprayer A=Connection X-offset **3** and ISOBUS Sprayer B=Section X-offset **4** entries
 - ▶ **1 + 3 + 4 = 5**
- ▶ Implement Lateral Offset Direction **2** – same direction as Aeros Connection Point Lateral Offset Direction
- ▶ Implement Lateral Offset Distance **2** – same value as on Aeros Connection Point Lateral Offset Distance

Figure 32: Always Rear Mount

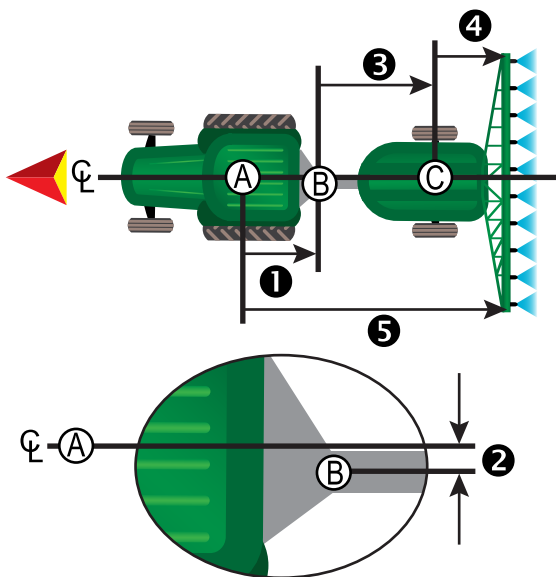

- A** – Centre of the GNSS antenna
- B** – Connection Point
- C** – Centre of the front axle of the trailed implement
- 1** – Connection Point In-line Offset Direction/Distance
- 2** – Connection Point Lateral Offset Direction/Distance
- 3** – A=Connection X-offset distance
- 4** – B=Section X-offset distance
- 5** – Implement In-line Offset Direction/Distance

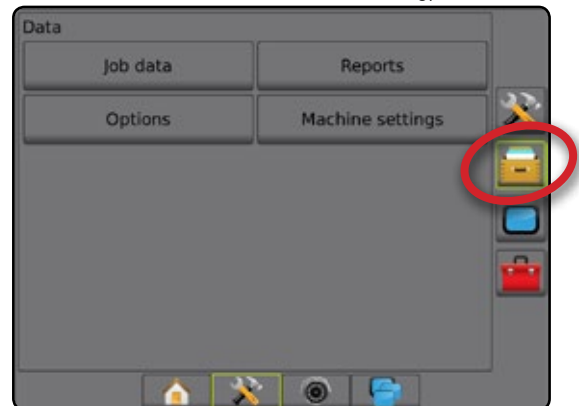





Job Data

When in advanced job mode, job data options are used to transfer job information (delete, import, export) and manage job information (create a new job, delete a job, or copy a job's guidelines, boundaries, applied data, prescription map and/or polygons to a new job).

Job Data includes:

- Job name
- Client, Farm, and Field names
- Boundary (exterior, interior)
- Polygons
- Coverage Area
- Guidelines
- Maps (Coverage, Prescription, Application, Preset Target Rate)
- Nozzle Faults

1. Press DATA MANAGEMENT side tab .
2. Press **Job Data**.
3. Select from:
 - ▶ Transfer – when in advanced job mode, allows the transfer of selected jobs to or from a USB drive , as well as deleting jobs . Jobs transferred to a USB storage device can be opened and updated using Fieldware Link. In Fieldware Link a user can input client, farm and field data as well as copy/edit jobs for reuse of boundaries and guidelines. From Fieldware Link, jobs can be ported back to a USB storage device to be moved back onto the console internal storage for use.
 - ▶ Manage – when in advanced job mode, allows the creation of a new empty job, copying of a selected job's Guidelines, Boundaries, Applied Data, and/or Prescription Map to a new job, as well as deleting a selected job
4. Press RETURN arrow  or DATA MANAGEMENT side tab  to return to the main Data Management screen.

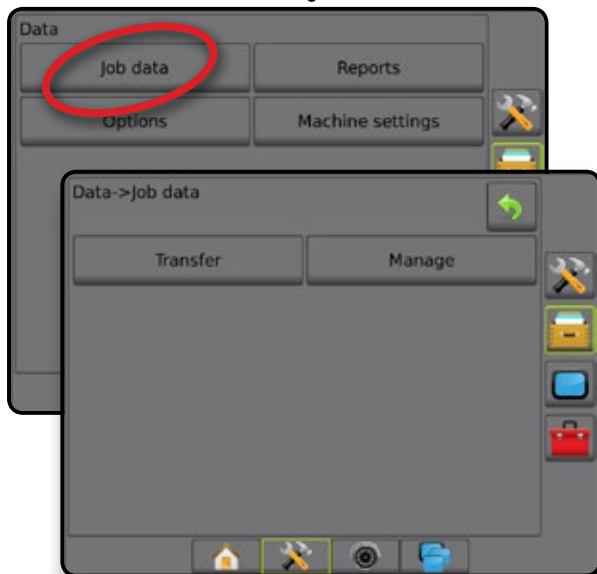

Copy job data

When in advanced job mode, the copy job data option is used to duplicate job information (guidelines, boundaries, applied data, prescription map and/or polygons) to a new job.





1. Press DATA MANAGEMENT side tab .
2. Press **Job Data**.
3. Press **Manage**.
4. Select the job data from which job information is to be duplicated.
5. Press **Copy**.
6. Select the job's guidelines, boundaries, applied data, prescription map and/or polygons to be copied into a new job.
7. Press **Copy**.
8. Name the new job.
9. Press the ACCEPT icon  to save the new job or the CANCEL icon  to leave the keyboard without saving.
10. Press RETURN arrow  or DATA MANAGEMENT side tab  to return to the main Data management screen

Figure 33: Job Data – Copy Data





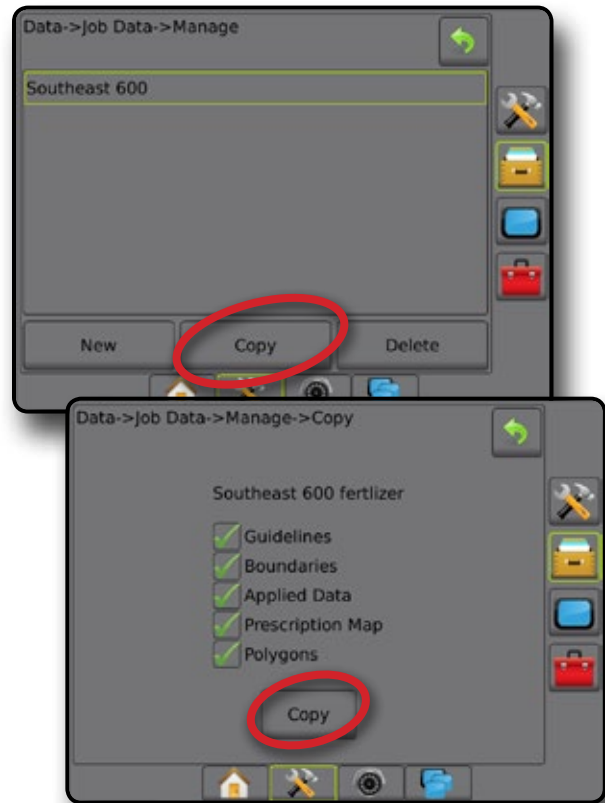

Machine Settings

The Machine Settings menu is used to create and manage individual Machine Profiles representing the configuration of the console on a particular vehicle/equipment setup. Each Machine Profile records the settings in use at the time the profile is generated allowing the customer to recall their exact setup for later use. Machine Profiles can be used to transfer settings to another console of the same make and model with the same attached hardware.

Machine Settings include:

- Implement settings
- AutoSteer/Tilt Correction settings
- Rate Control settings
- Job-specific settings (including application rates, application type, and Product Channel assignments)

NOTE: Not all settings are saved as part of the machine settings. See the appendix "Aeros Console Menu Settings" for details.

1. Press DATA MANAGEMENT side tab .
2. Press **Machine Settings**.
3. Select from:
 - ▶ Transfer – allows the transfer of selected machine settings to or from a USB drive , as well as deleting machine settings . Machine settings transferred to a USB storage device can be opened and updated using Fieldware Link. From Fieldware Link, machine settings can be ported back to a USB storage device to be moved back onto the console internal storage for use.
 - ▶ Manage – allows the creation of a new empty machine settings, the copying of a selected machine settings to a new machine settings, the deletion of a selected machine settings, the saving of the current machine settings to the selected machine settings, or the loading of the selected machine settings to the current settings
4. Press RETURN arrow  or DATA MANAGEMENT side tab  to return to the main Data Management screen.

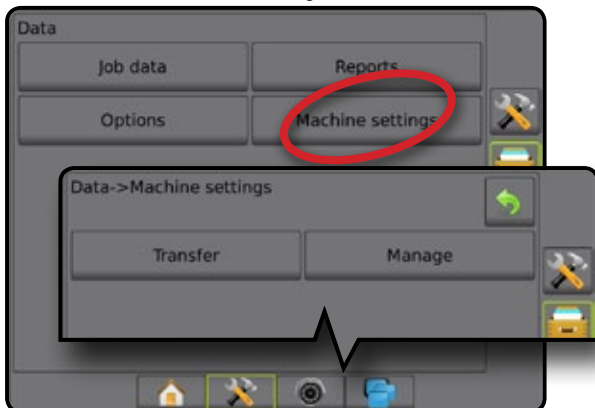

Copy machine profile

The copy machine profile option is used to duplicate the selected machine profile for recall of that profile at a later use. Machine profiles can be used to transfer settings to another console of the same make and model with the same attached hardware.





1. Press DATA MANAGEMENT side tab .
2. Press **Machine settings**.
3. Press **Manage**.
4. Select the machine profile to be copied into a new profile.
5. Press **Copy**.
6. Name the new profile.
7. Press the ACCEPT icon  to save the new profile or the CANCEL icon  to leave the keyboard without saving.
8. Press RETURN arrow  or DATA MANAGEMENT side tab  to return to the main Data management screen

Figure 34: Machine Settings – Copy Profile



Aeros 9040 field computer

SYSTEM CONFIGURATIONS

The following diagrams are reflective of typical Aeros configurations. Due to the variety of possible configurations, this should be used for reference purposes only.

Figure 35: Aeros IC18 Spreader

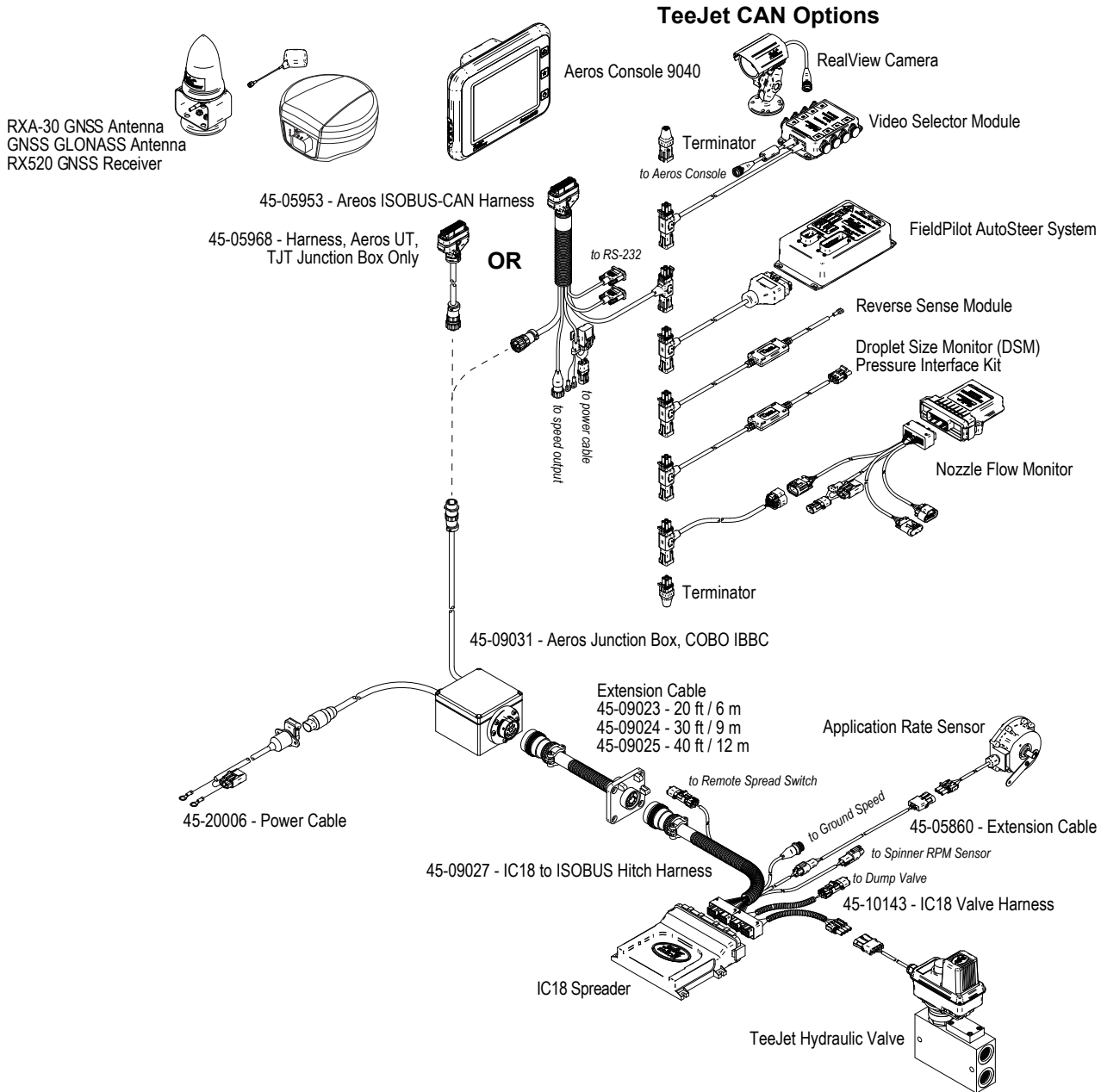
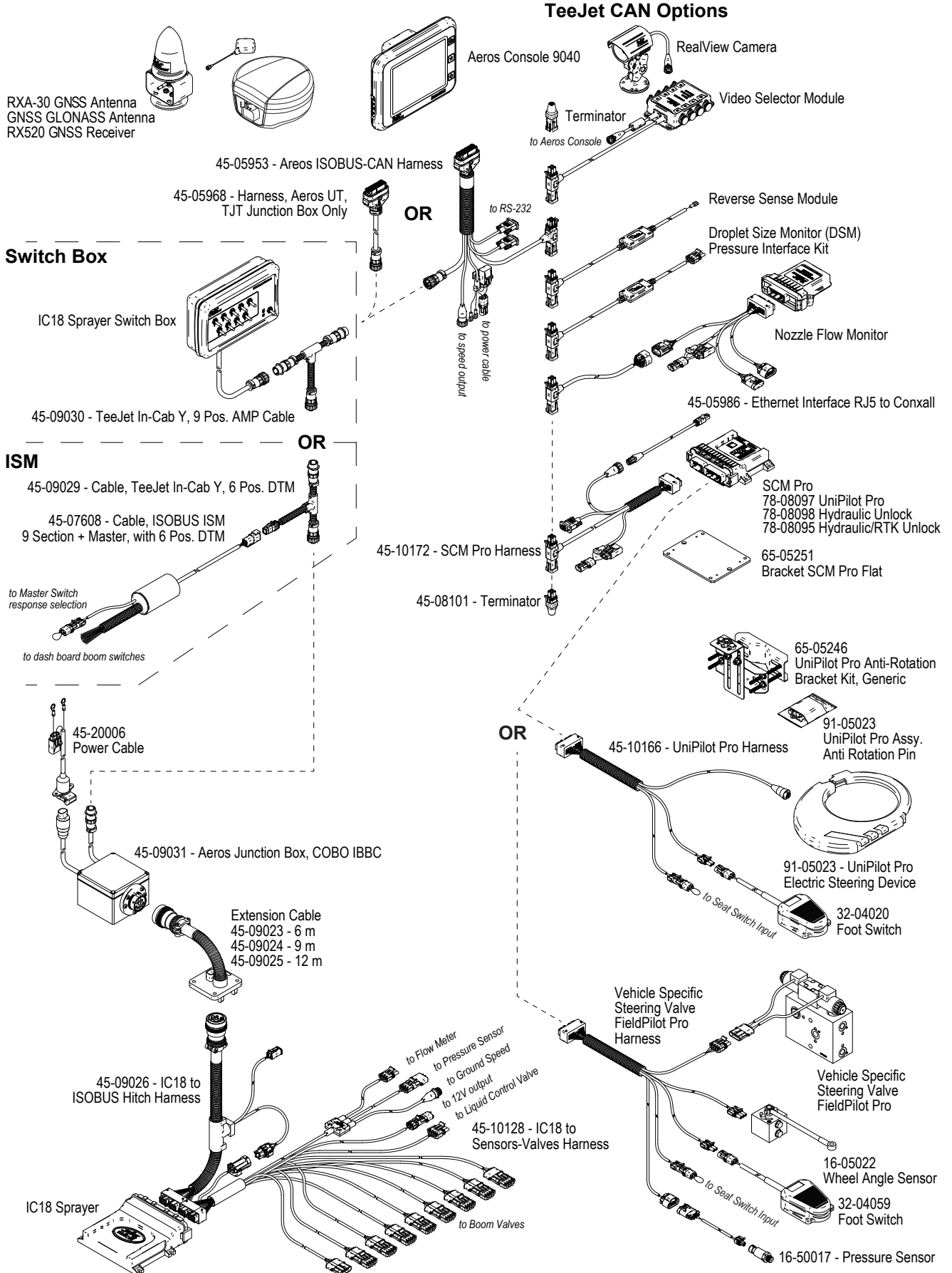

Figure 36: Aeros IC18 Sprayer with FieldPilot Pro or UniPilot Pro Steering System



AEROS[®] 9040

U S E R G U I D E

START SIMPLE GUIDANCE

NO.1 POWER ON

NO.2 HOME SCREEN

NO.3 GO TO CONFIGURATION

- 1) Set Up the Local Cultural Settings
- 2) Set Up the GNSS
- 3) Set Up the Implement
- 4) Set Up the Mapping Location

NO.4 START NEW JOB OR CONTINUE JOB

NO.5 SET UP GUIDANCE

- 1) Choose a Guidance Mode
- 2) Establish an AB guideline
- 3) Create an Application Boundary

ADD RATE CONTROL

ISOBUS UNIVERSAL TERMINAL



www.teejet.com

A Subsidiary of  **Spraying Systems Co.**[®]

98-01504-EN-A4/LT R4 English International
© TeeJet Technologies 2018