

AEROS 9040

U S E R M A N U A L

Software version 4.32



TeeJet[®]
TECHNOLOGIES

A Subsidiary of  **Spraying Systems Co.**[®]

Copyrights

© 2017 TeeJet Technologies. All rights reserved. No part of this document or the computer programs described in it may be reproduced, copied, photocopied, translated, or reduced in any form or by any means, electronic or machine readable, recording or otherwise, without prior written consent from TeeJet Technologies.

Trademarks

Unless otherwise noted, all other brand or product names are trademarks or registered trademarks of their respective companies or organizations.

Limitation of liability

TEEJET TECHNOLOGIES PROVIDES THIS MATERIAL "AS IS" WITHOUT WARRANTY OF ANY KIND, EITHER EXPRESSED OR IMPLIED. NO COPYRIGHT LIABILITY OR PATENT IS ASSUMED. IN NO EVENT SHALL TEEJET TECHNOLOGIES BE LIABLE FOR ANY LOSS OF BUSINESS, LOSS OF PROFIT, LOSS OF USE OR DATA, INTERRUPTION OF BUSINESS, OR FOR INDIRECT, SPECIAL, INCIDENTAL, OR CONSEQUENTIAL DAMAGES OF ANY KIND, EVEN IF TEEJET TECHNOLOGIES HAS BEEN ADVISED OF SUCH DAMAGES ARISING FROM TEEJET TECHNOLOGIES SOFTWARE.



Safety information

TeeJet Technologies is not responsible for damage or physical harm caused by failure to adhere to the following safety requirements.

As the operator of the vehicle, you are responsible for its safe operation.

The Aeros 9040 in combination with any assisted/auto steering device is not designed to replace the vehicle's operator.

Do not leave a vehicle while the Aeros 9040 is engaged.

Be sure that the area around the vehicle is clear of people and obstacles before and during engagement.

The Aeros 9040 is designed to support and improve efficiency while working in the field. The driver has full responsibility for the quality and work related results.

Disengage or remove any assisted/auto steering device before operating on public roads.

Table of contents

CHAPTER 1 – INTRODUCTION	1
Product upgrades available	1
SYSTEM COMPONENTS	1
Aeros 9040 console	1
Buttons	2
RealView® camera	2
Additional information	2
BASIC SCREEN USE	3
Bottom tab keys	3
Unavailable options when job is active	3
Console screen colours	4
Simple or advanced mode	4
Warnings and information pop-ups	5
Setup option information	5
Drop-down menu selections	5
Scrolling screens	5
Keyboard entry screen	6
Next page	6
Checkboxes	6
CHAPTER 2 – JOBS / HOME SCREEN	7
Simple mode	7
Advanced mode	7
SIMPLE MODE	8
New job	8
Continue job	8
Close job	8
ADVANCED MODE	8
New job	8
Start job	8
Close job	8
CHAPTER 3 – FULL SCREEN VIDEO VIEW	9
Camera snapshot	10
VSM camera options	10
CHAPTER 4 – SYSTEM SETUP	11
Overview	11

Aeros 9040 field computer

INTRODUCTION
HOME
FULL SCREEN
SETUP
GNSS
IMPLEMENT
GUIDANCE
RATE CONTROL
APPENDIX



CONFIGURATION

12

Implement.....	13
Single section setup	13
Section(s) with ISOBUS sprayer/spreader setup.....	14
Multiple sections with SDM/SFM setup	15
Droplet size monitor	16
Nozzle selection	16
Reverse sense options	17
Mapping and guidance	17
Mapping and guidance [console only].....	17
Mapping and guidance using an external lightbar	18
User entered mapping location	19
GNSS.....	20
Video	21
Sensors	21
Input/output module pressure sensor.....	22
Nozzle flow monitor	23
ISOBUS.....	23
Product.....	24
AutoSteer.....	25
FieldPilot [using a SCM].....	25
FieldPilot Pro / UniPilot Pro [using a SCM Pro].....	25
Tilt correction	27



DATA MANAGEMENT

28

Job data.....	28
Transfer	29
Manage.....	29
Reports	31
Options (Job mode).....	32
Machine settings.....	33
Transfer	33
Manage.....	34



CONSOLE

35

About	35
Display	36
Cultural.....	36
Audio volume.....	37
Demo GNSS	37
Restart Demo GNSS	38
Feature unlock.....	38



TOOLS

39

Upload software.....	39
Extras.....	40

CHAPTER 5 – GNSS RECEIVER CONFIGURATION

41

GNSS	41
GNSS type	42
GNSS port	42
Programme	44
PRN	44
Show refresh GNSS position button	45
GNSS glossary	45

CHAPTER 6 – IMPLEMENT SETUP

47

Multiple section output modules	47
---------------------------------------	----

IMPLEMENT TYPE

48

Section numbers	48
Straight	48
Single section	48
Multiple sections with SDM or SFM	49
Multiple sections with ISOBUS sprayer setup	50
Spreader – TeeJet	51
Single section	51
Multiple sections	52
Spreader – OEM	54
Single section	54
Multiple sections	54
Staggered	55
Multiple sections	55

APPLICATION OR WORKING WIDTH

57

Single section	57
Multiple sections	57

ISOBUS SPRAYER OFFSETS

58

Self-propelled – front mount	58
Self-propelled – rear mount	59
Three point hitch – front mount	59
Three point hitch – rear mount	60
Trailed – always rear mount	61

IMPLEMENT LATERAL OFFSET DISTANCE ADJUSTMENT

62

GNSS offset adjustment calculation	62
Implement lateral offset adjustment	63

REVERSE SENSE

64

Reverse on guidance screens	64
-----------------------------------	----

NOZZLE SELECTION











65

Preset	65
Current nozzle	66

Aeros 9040 field computer

INTRODUCTION
 HOME
 FULL SCREEN
 SETUP
 GNSS
 IMPLEMENT
 GUIDANCE
 RATE CONTROL
 APPENDIX

DROPLET SIZE MONITOR		66
Setup.....		66
Enable/disable DSM.....		66
Nozzle selection / current nozzle.....		66
Input/output module pressure sensor.....		66
Operation.....		67
Status bar.....		67
Guidance bar.....		67
BOOMPILOT SECTION CONTROL		68
CHAPTER 7 – GUIDANCE AND MAPPING		69
Overview.....		69
Screens options.....		70
GUIDANCE BAR		74
Navigation activity & Boom status.....		74
Selectable Information.....		74
STATUS BAR		75
Status/information screens.....		76
NAVIGATION SCREENS		78
Vehicle view.....		78
Field view.....		79
RealView guidance.....		80
GUIDANCE MODES		81
Straight AB guidance.....		81
Curved AB guidance.....		81
Adaptive curve AB guidance.....		81
Circle pivot guidance.....		81
Last pass guidance.....		81
NextRow guidance.....		82
No guidance.....		82
GUIDELINES		82
Marking A and B points.....		82
A+ nudge feature.....		83
Next guideline feature.....		84
Last pass guidelines.....		84
NextRow guidelines.....		85
Azimuth degree.....		85
RETURN TO POINT		86
Marking a return point.....		86
Delete the return point.....		86
Guidance to a return point.....		86

	BOOMPILOT	87
	No Section control module.....	87
	ISOBUS sprayer.....	88
	ISOBUS spreader.....	89
	With TeeJet section control module and switchbox or ISM.....	90
	With TeeJet section control module.....	90
	CURVED LOOKAHEAD	90
	REFRESH GNSS POSITION	91
	NOZZLE FAULT RESET	91
	BOUNDARIES AND POLYGONS	92
	Boundaries.....	92
	Establishing an exterior or interior boundary.....	92
	Delete last marked boundary.....	94
	Boundary on status bar.....	94
	Polygons.....	94
	Establishing a polygon.....	94
	Delete last marked polygon.....	95
	MAPPING OPTIONS	96
	Polygon mapping.....	96
	Rate control mapping.....	96
	APPLICATION CONTROL OPTIONS	97
	ZOOM IN/OUT	97
	Vehicle view.....	97
	Field view.....	97
	PAN MODE	98
	REALVIEW SPECIFIC OPTIONS	98
	RealView guidance options.....	99
	Camera snapshot.....	99
	VSM camera options.....	99
CHAPTER 8 – RATE CONTROL		101
	Ready for operation.....	102
	ISOBUS configuration options.....	102
	NAVIGATION SCREEN OPTIONS	103
	Guidance bar.....	103
	Current pressure.....	103

Aeros 9040 field computer

Application control options	103
Mapping options	104



MAPPING OPTIONS 104

Coverage map.....	105
Polygons map	105
Prescription map.....	106
Application and target rate maps.....	106
Application map	106
Target rate map	107
Colour range selection	107

APPENDIX A – SYSTEM CONFIGURATIONS 109

APPENDIX B – AEROS CONSOLE MENU SETTINGS 112

APPENDIX C – UNIT SPECIFICATIONS 116

APPENDIX D – SETTING RANGES 116

APPENDIX E – UTM COORDINATES AND ZONES 117

INTRODUCTION

HOME

FULL SCREEN

SETUP

GNSS

IMPLEMENT

GUIDANCE

RATE CONTROL

APPENDIX

CHAPTER 1 – INTRODUCTION

The Aeros 9040 field computer allows the management of multiple connected modules plus GNSS mapping, guidance, FieldPilot®, BoomPilot®, ISOBUS Rate Control, Nozzle Flow Monitor, and data collection in a single console using CAN bus technology. This replaces multiple consoles in the cab with one robust system.

Product upgrades available

- FieldPilot® Pro auto steering
- UniPilot® Pro assisted steering
- BoomPilot® automated boom section control
- Tilt gyro module
- Video selection modules for up to 8 cameras
- External GNSS receiver or antenna upgrades
- Fieldware® Link enhanced data organization application
- Pressure sensor interface kit for droplet size monitor
- ISOBUS rate control
- Reverse sense module
- Nozzle flow monitoring

SYSTEM COMPONENTS

Aeros 9040 console

The Aeros 9040 is designed to provide years of service under typical agricultural operating conditions. A tight fitting enclosure, combined with rubber covers for all connectors mean that typical dusty environments will not cause operational problems. While occasional splashing of water will not damage the unit, the Aeros 9040 is not designed for direct exposure to rain. Take care not to operate the Aeros 9040 in wet conditions.

Figure 1-1: Aeros 9040 console front



Aeros 9040 field computer

Figure 1-2: Aeros 9040 console back

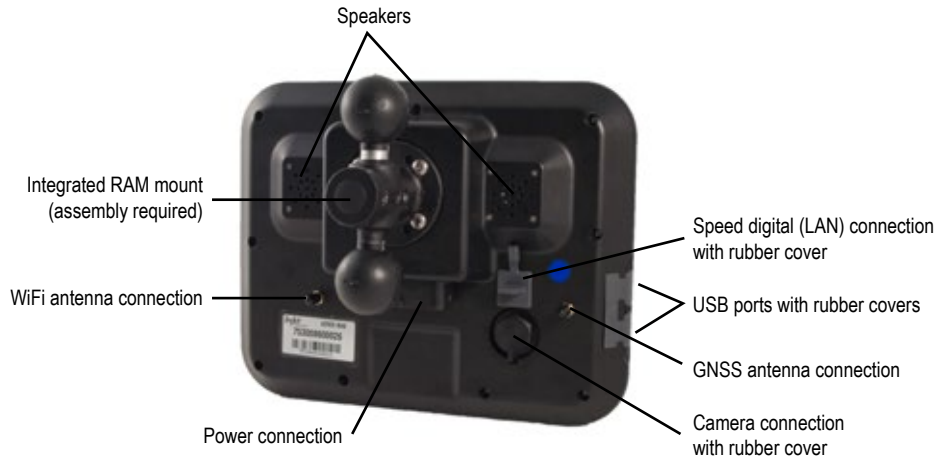

Buttons

Home

The Home button  provides a shortcut to the Home screen.

Favorites

The Favorites button  provides a shortcut to a frequently used console bottom tab. To assign a tab to the button, navigate to that tab's screen, then press and hold the Favorites button until it beeps.

Power on/off

On – Press the POWER button  to power on the console. Upon power up, the Aeros will begin its start up sequence.

Off – Press and briefly hold the POWER button  until a confirmation screen acknowledges shut down mode.

WARNING! Wait 10 seconds before restarting the console.

RealView® camera

The TeeJet Technologies RealView camera allows video images to be displayed on the Aeros screen. The camera can be pointed forward to enable RealView guidance over video, or it can be positioned to view other operational aspects of your equipment. The camera is equipped with a flexible RAM mount, integral sun shade and provides infrared illumination, allowing clear video images even in dark conditions.

Additional information

All changes are saved automatically.

The console needs to be cycled off and back on when changing or attaching equipment to the Aeros system.

Start up sequence

The console takes approximately two-three minutes to power up. During this time a series of screens will be displayed, LEDs will power on and off, and brightness levels will fluctuate. Once the power up sequence has completed, the Home screen will appear.

Recommended antenna installation

The GNSS antenna should be mounted as far forward as possible on top of the cab on a metal surface of at least 10 cm × 10 cm.

USB ports

Only one USB port can be used at any given time.

BASIC SCREEN USE





The Aeros 9040 can be used as a simple current job system or advanced multi-job system. Regardless of which mode the console is in, the basic screen functions are the same.

- Bottom tabs and side tabs access the various screens and sub-screens
- Warnings and information pop-ups inform user of console activities and details on setup or guidance functions
- Setup options can easily be set using the drop-down menus or keyboard entry screens

To quickly find a setup feature, see “Aeros console menu settings” in this manual.

Bottom tab keys

The bottom tab keys are always available on screen. These keys give access to jobs, setup options, and navigation.

-  Home/job screen
-  System setup
-  Vehicle view guidance
-  Field view guidance
-  RealView guidance or RealView camera full screen video view

NOTE: RealView Guidance options are only available with a camera installed on the system.

-  ISOBUS universal terminal

Figure 1-3: Bottom tab keys

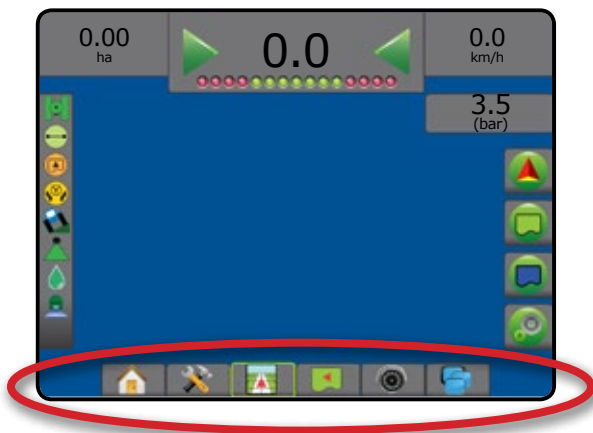

Unavailable options when job is active

When a job is active some setup options are unavailable: see “Aeros console menu settings” in this manual.

Figure 1-4: Examples of unavailable options

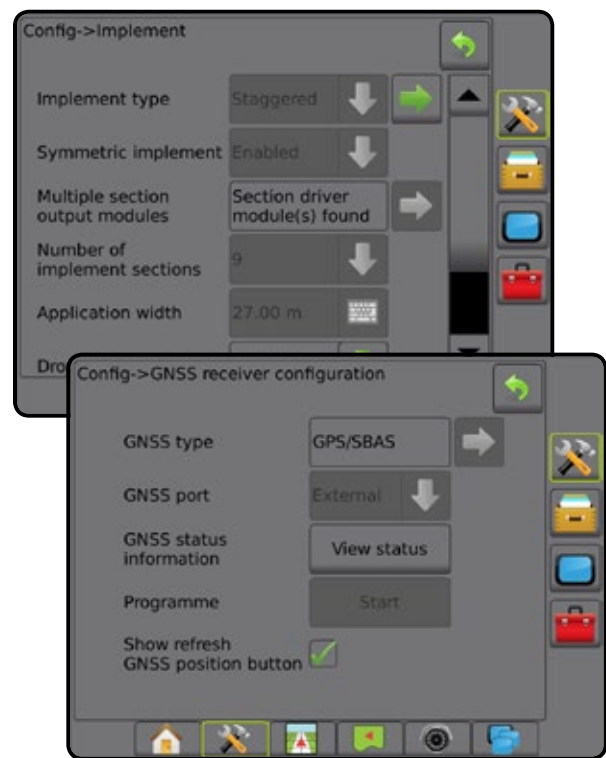

Console screen colours

The console is available in six colour schemes. From the System setup bottom key, press CONSOLE side tab and enter the **Display** options. Press DOWN arrow to access the Colour scheme options to select colour mode.

Figure 1-5: Colour schemes



Simple or advanced mode

To change between simple mode and advanced mode, see the configuration chapter under Data -> Options.

In simple mode, only one job will be available at a time. Only bounded area and coverage areas are displayed on the home screen. Only the current job is available for saving in Reports. Use with Fieldware Link is not available.

Figure 1-6: Simple mode home screen

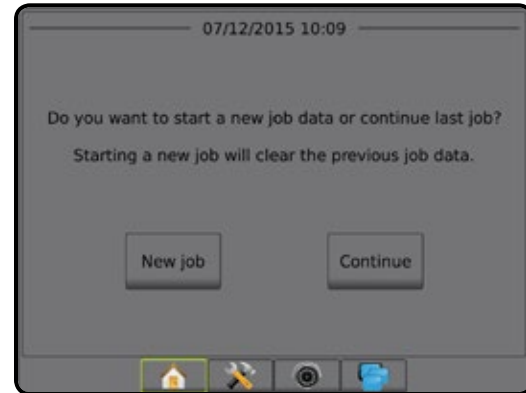

In advanced mode, more than one job will be available at any time. Client, farm, field and job names; bounded and coverage areas; application time; and distance from selected job are displayed on the home screen. All saved job profiles can be exported as a PDF, SHP or KML file to a USB drive using Data -> Reports.

Client information, farm information, field information, and prescription maps can only be inputted using Fieldware Link. A job name can only be edited using Fieldware Link.

A user can duplicate jobs for reuse of guidelines, boundaries, applied data, prescription map and/or polygons using Fieldware Link or Data -> Job data -> Manage in the console.

Figure 1-7: Advanced mode home screen

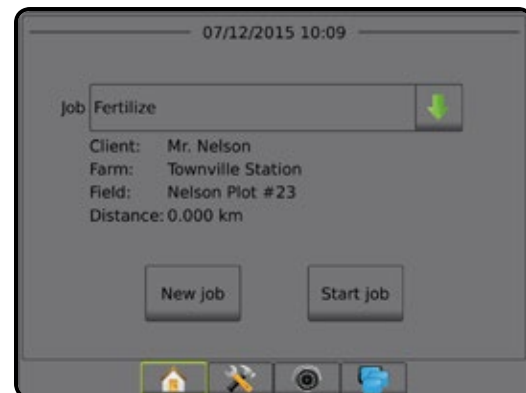

Warnings and information pop-ups

A pop-up warning or information box will be displayed for approximately five (5) seconds. To remove the information box, tap anywhere on the screen.

Figure 1-8: Example of information text box

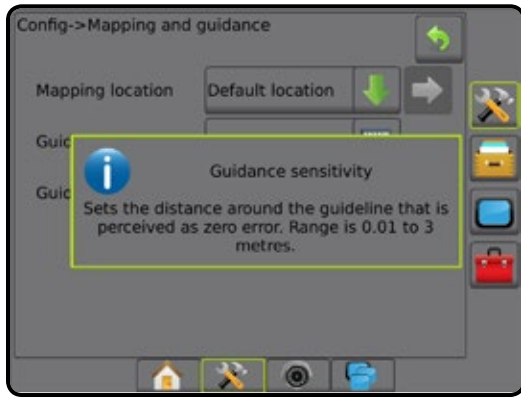

Setup option information

Press the option's icon or option's name of any menu item to display a definition and range values of that item. To remove the information box, press anywhere on the screen.

Figure 1-9: Example of information text box

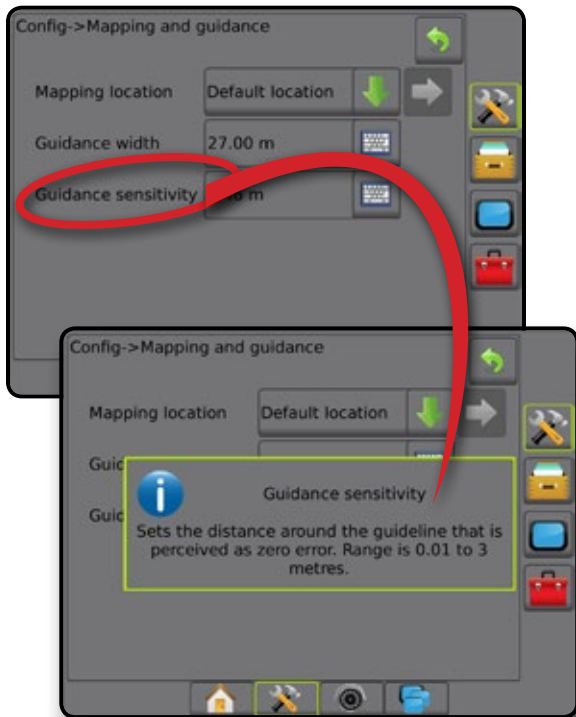

Drop-down menu selections



Press DOWN arrow  to access the options. Use the UP/DOWN arrows   or slide bar if necessary to scroll through the extended list. Select the appropriate option. To close the list without selecting an option, tap anywhere on the screen outside the drop-down menu.

Figure 1-10: Example of drop-down menu



Scrolling screens



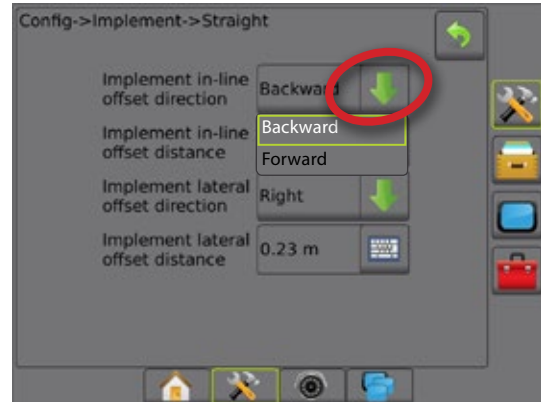

Some screens have more information or options that are visible beyond the current screen. Use the UP/DOWN arrows   or slide bar to access additional options or information not currently visible on the screen.

Figure 1-11: Example of scrolling screen

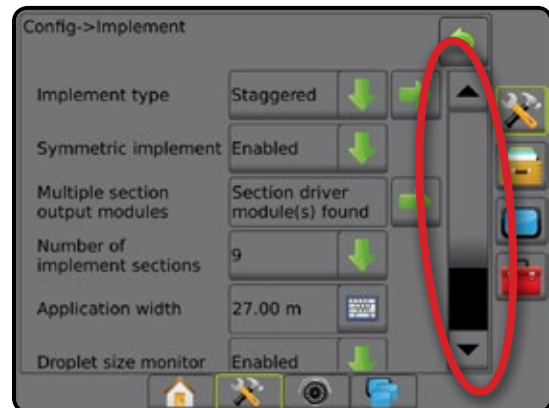

Keyboard entry screen

Press the KEYPAD icon . Use the numeric keypad to enter a value.

Press the ACCEPT icon  to save the settings or the CANCEL icon  to leave the keypad without saving.

Figure 1-12: Example of keyboard

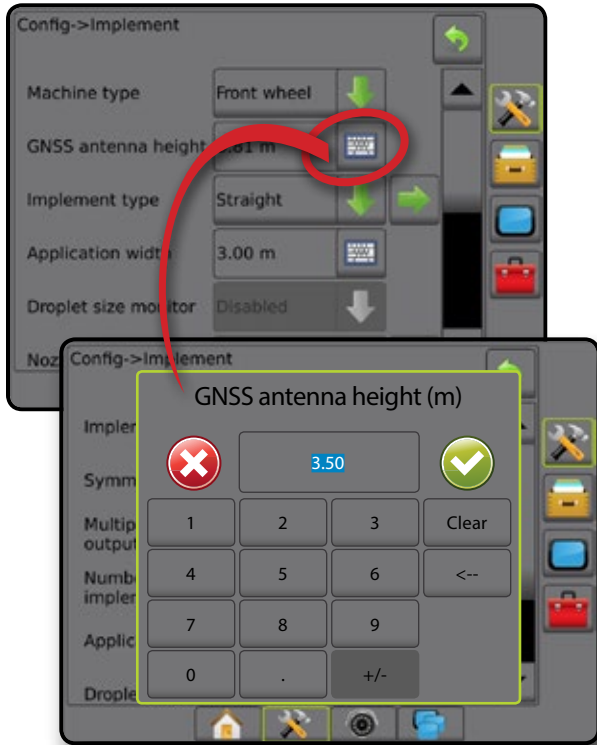

Next page

Press the NEXT PAGE arrow  to set up additional options for the selected item.

Figure 1-13: Example of next page



Checkboxes

Press the CHECKBOX / to select or deselect.

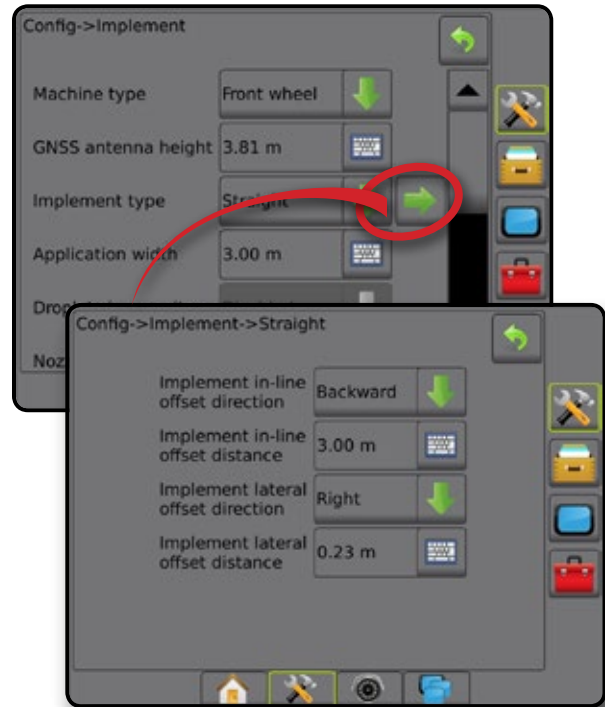
Figure 1-14: Example of checkboxes



CHAPTER 2 – JOBS / HOME SCREEN

Once the power up sequence has completed and the console is receiving GNSS, the Home screen will appear with the option to start a new job or continue an existing job.

Setup for the specific machine and its components must be completed before starting a job. Once a job is active, some setup options can no longer be changed. See “Aeros console menu settings” in the appendix of this manual.

To change between simple and advanced mode, go to Data-> Options-> Job mode in the System setup.

Simple mode

In simple mode, only one job will be available at a time. Only bounded area, coverage areas, and application time are displayed on the home screen. Only the current job is available for saving in Reports. Use with Fieldware Link is not available.

Figure 2-1: Simple mode home screen



Advanced mode

In advanced mode, more than one job will be available at any time. Client, farm, field and job names; bounded and coverage areas; application time; and distance from selected job are displayed on the home screen. All saved job profiles can be exported as a PDF, SHP or KML file to a USB drive using Data -> Reports.

Client information, farm information, field information, and prescription maps can only be inputted using Fieldware Link. A job name can only be edited using Fieldware Link.

A user can duplicate jobs for reuse of guidelines, boundaries, applied data, prescription map and/or polygons using Fieldware Link or Data -> Job data -> Manage in the console.

Figure 2-2: Advanced mode home screen

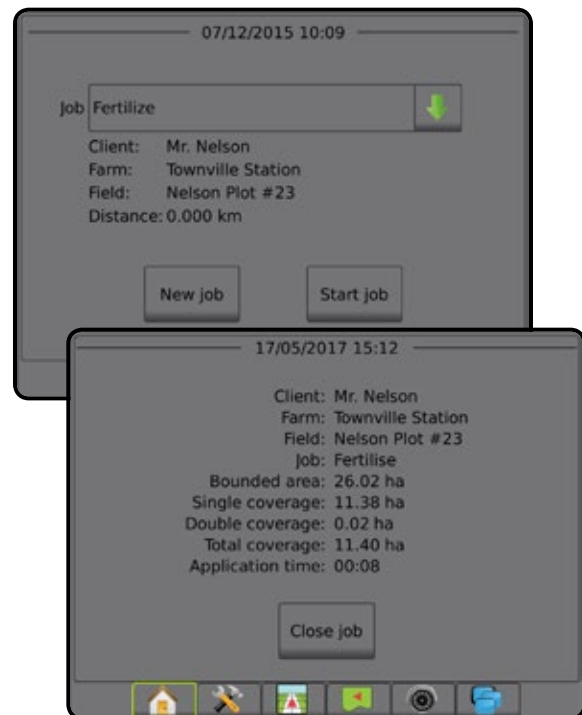

SIMPLE MODE

Once the power up sequence has completed, the Home screen will appear with the option to start a new job or continue an existing job.

The console must have GNSS before starting or continuing a job.

New job

Starting a new job will clear the previous job data.

To start a new job:

1. On the Home screen , press **New job**.

The console will jump to Vehicle View.

Continue job

To continue the existing job:

1. On the Home screen , press **Continue**.

The console will jump to Vehicle view and begin providing navigation information.

Distance

If a selected job is in a UTM zone other than the current or adjacent UTM zone, “Out of range” will be displayed next to Distance, and

Continue will be disabled.

NOTE: For more information, see the UTM zone appendix.

If a selected job has no recorded information, Distance will show “No data”.

Close job

To close a job:

1. On the Home screen , press **Close job**.

To create a report of the job when closing a job:

1. Insert a USB drive into the USB port of the console.
2. On the Home screen , press **Close job**.
3. Select:
 - ▶ Yes – to create a report of the last job
 - ▶ No – to return to the Home screen without saving

ADVANCED MODE

Once the power up sequence has completed, the Home screen will appear with the option to start a new job or continue an existing job.

The console must have GNSS before starting or continuing a job.

New job

Starting a new job will clear the previous job data.

To start a new job:

1. On the Home screen , press **New job**.

2. Press:

- ▶ Yes – to automatically generate a name
- ▶ No – to enter a name using the on screen keyboard



Client, farm, and field information are inputted using Fieldware Link.

The console will jump to Vehicle view.

Start job

The Aeros 9040 is programmed with a field finder tool to assist the user in finding the job closest to the vehicle’s location. With GNSS acquired, the job pick list will be updated every ten seconds. During this update, the list of jobs is sorted by distance and the closest two jobs are displayed on the top of the list. The remaining jobs are listed beneath these.

To continue the existing job:

1. On the Home screen , press DOWN arrow  to access the list of jobs saved in the console.
2. Select the job name to be started/continued.
3. Press **Start job**.

The console will jump to Vehicle View and begin providing navigation information.

Distance

If a selected job is in a UTM zone other than the current or adjacent UTM zone, “Out of range” will be displayed next to Distance, and

Start job will be disabled.

NOTE: For more information, see the UTM zone appendix.

If a selected job has no recorded information, Distance will show “No data”.

Close job

To close a job:

1. On the Home screen , press **Close job**.

To create a report of the job when closing a job:

1. Insert a USB drive into the USB port of the console.
2. On the Home screen , press **Close job**.
3. Select:
 - ▶ Yes – to create a report of the last job
 - ▶ No – to return to the Home screen without saving

CHAPTER 3 – FULL SCREEN VIDEO VIEW

RealView full screen video view allows live video input to be displayed. View video feed(s) and setup cameras without GNSS available. Options for RealView guidance are not available on this screen.

- ▶ Single camera – a single camera is directly attached to the console
- ▶ Video selection module – if a Video Selection Module (VSM) is installed on the system, two (2) video options are available:
 - One camera view – one of up to eight camera inputs can be selected to change the view of the video input.
 - Split camera view – one of two sets of four camera inputs (A/B/C/D or E/F/G/H) can be selected to divide the screen into four separate video feeds.

To adjust the camera view [reverse, upside down], go to Setup-> Configuration-> Video.

To enter Full screen video mode:





1. Press REALVIEW CAMERA FULL SCREEN VIDEO VIEW bottom tab .
2. Press REALVIEW OPTIONS tab  to display RealView options.
3. Select from:
 - ▶ Single camera view  [VSM only] – one (1) of up to eight (8) camera inputs can be selected to change the view of the video input
 - ▶ Split camera view  [VSM only] – one (1) of two (2) sets of four (4) camera inputs (A/B/C/D or E/F/G/H) can be selected to divide the screen into four separate video feeds
 - ▶ RealView camera image capture  – saves a still photo of the current view on the screen to a USB drive

Figure 3-1: RealView full screen video view



Aeros 9040 field computer

Camera snapshot

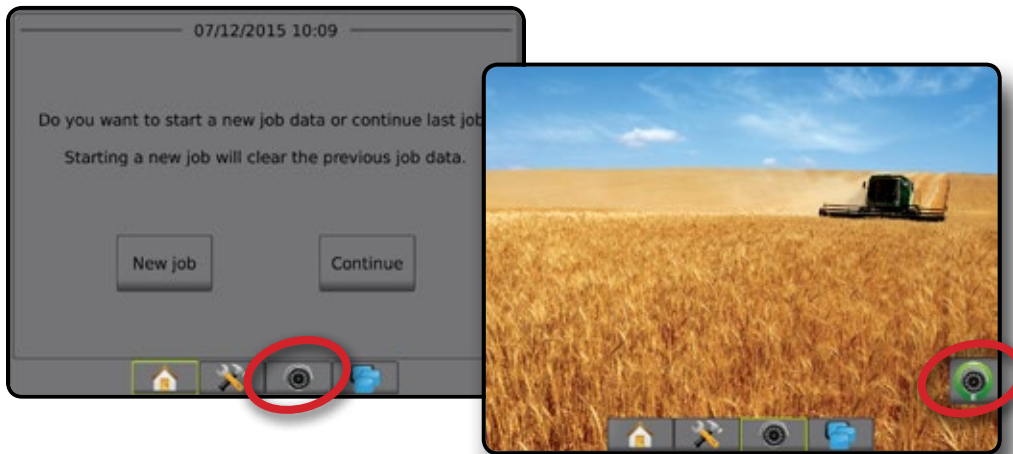
RealView camera snapshot saves a still photo of the current view on the screen to a USB drive.



1. Insert USB drive.
2. Press REALVIEW CAMERA FULL SCREEN VIDEO VIEW bottom tab .
3. Press REALVIEW OPTIONS tab  to display RealView options.
4. Press CAMERA SNAPSHOT icon .

Figure 3-2: RealView camera full screen video view



Figure 3-3: Single camera selection with VSM

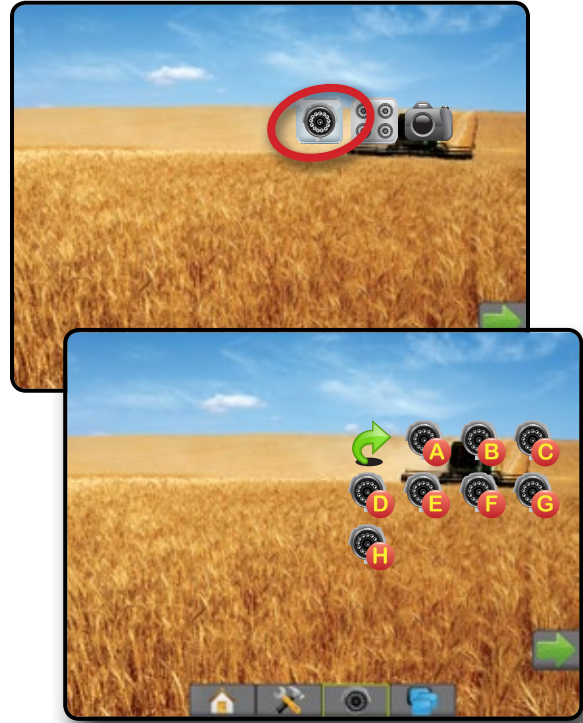





Figure 3-4: Select split view with VSM



VSM camera options

If a Video selection module (VSM) is installed on the system, two (2) video options are available:

1. Press REALVIEW CAMERA FULL SCREEN VIDEO VIEW bottom tab .
2. Press REALVIEW OPTIONS tab  to display RealView options.
3. Select from:
 - ▶ Single camera view  – one (1) of up to eight (8) camera inputs can be selected to change the view of the video input.
 - ▶ Split camera view  – one (1) of two (2) sets of four (4) camera inputs (A/B/C/D or E/F/G/H) can be selected to divide the screen into four separate video feeds.

CHAPTER 4 – SYSTEM SETUP

System Setup is used to configure the console, the machine and its implements. Four side tabs access options for Machine/Implement Configuration, Data management, Console settings, and Tools.

Overview

Four side tabs access setup options for:





-  Configuration
 - Implement (straight, spreader, or staggered implement configurations; nozzle selection information including droplet size monitor, reverse configuration)
 - Mapping and Guidance (mapping location, guidance sensitivity, external lightbar)
 - GNSS receiver configuration
 - Video configuration
 - Sensors (Input/output module (IOM) pressure sensor)
 - Nozzle flow monitor
 - ISOBUS configuration
 - Product configuration
 - AutoSteer
 - ◀ FieldPilot (valve setup, steering settings, valve test, valve diagnostics, steering wheel sensor, steering angle sensor)
 - ◀ FieldPilot Pro / UniPilot Pro (manage vehicle, calibrations, adjustments, select qi values, transport mode, service mode)
 - Tilt correction
-  Data management
 - Job data (transfer, manage)
 - Reports
 - Options (job mode)
 - Machine settings (transfer, manage)
-  Console settings
 - About (system information)
 - Display
 - Cultural
 - Audio volume
 - Demo GNSS
 - Feature unlock
-  Tools
 - Upload software
 - Extras (calculator, units converter)



Figure 4-1: Setup options

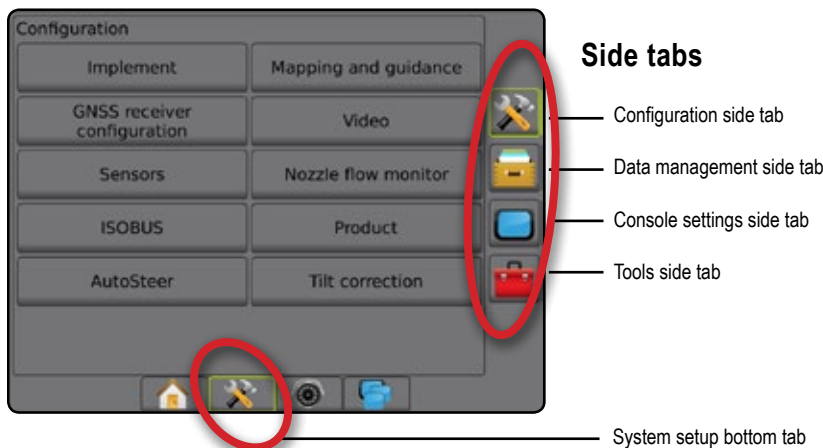

CONFIGURATION

Configuration is used to configure the system components including implements, guides, steering, monitors and sensors.

NOTE: Feature availability will vary depending on the devices available and unlocked on the Aeros 9040 system.

1. Press SYSTEM SETUP bottom tab .
2. Press CONFIGURATION side tab .
3. Select from:
 - ▶ Implement – used to set (as appropriate) machine type, GNSS antenna height, implement type, symmetric implement layout, section output modules, number of implement sections, application/working width, droplet size monitor, nozzle selection, nozzle spacing, BoomPilot start mode, reverse sense module
 - In Straight mode – in-line/lateral implement offset direction/distance, overlap percentage, implement delay on/off time
 - In Spreader mode:
 - TeeJet – antenna to disks distance, lateral implement offset direction/distance, overlap percentage, delay on/off times, spread offset distance, section offset distances, section lengths
 - OEM – antenna to disks distance, lateral implement offset direction/distance, start/stop distance, section start/stop offset distances
 - In Staggered mode – in-line/lateral section 1 offset direction/distance, overlap percentage, delay on/off times, section offsets

- ▶ Mapping and guidance – used to configure the mapping location, guidance width, guidance sensitivity (cross track error) and/or an optional external lightbar module (ELM)
- ▶ GNSS – used to establish GNSS type, port, and PRN, as well as to view GNSS status information
- ▶ Video – used to set up individual cameras
- ▶ Sensors – used to establish pressure sensor settings
- ▶ Nozzle flow monitor – used to establish nozzle configuration, and to establish and calibrate flow limits and alarm behavior for nozzle flow monitors
- ▶ ISOBUS – used to select information for broadcast over the ISOBUS, and in troubleshooting
- ▶ Product – used to configure product name, tank/bin volumes, target application rates, increment for adjusting target rates, and colour mapping maximum/minimum rate limits and corresponding display colours
- ▶ AutoSteer – used to enable/disable and calibrate assisted/auto steering
 - FieldPilot – used to establish valve setup settings, steering settings, steering wheel and steering angle sensor settings, and to perform valve tests or valve diagnostics
 - FieldPilot Pro / UniPilot Pro – used to manage vehicle settings, calibrate sensors, select QI values, as well as establish transport mode and service mode
- ▶ Tilt correction – used to enable/disable and calibrate the tilt correction function, and improve application on hilly or sloped terrain

Figure 4-2: Configuration options

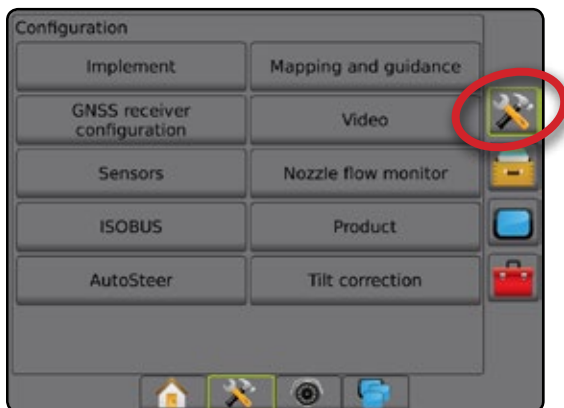

Implement

Implement setup is used to establish the various settings associated with straight mode, spreader mode, or staggered mode. Available settings will vary depending on the specific equipment present in the system.

This section includes setup options for these implement configurations:

- ▶ Single section
- ▶ Section(s) with ISOBUS sprayer/spreader setup
- ▶ Multiple sections with Section driver module or Switch function module

NOTE: For more information, see the Implement chapter of this manual.

Implement type

Implement type selects the type of application pattern that most closely represents your system.

- In Straight mode – the boom sections have no length and are on a line a fixed distance from the antenna
- In Spreader mode – a virtual line is created in line with the delivery disks from which the application section or sections can vary in length and can be at different distances from the line (availability depends on the specific equipment in the system)
- In Staggered mode – a virtual line is created in line with section 1 from which the application section or sections have no length and can be at different distances from the line (availability depends on the specific equipment in the system)

NOTE: For more information, see "Implement type" in the Implement chapter of this manual.

Figure 4-3: Implement type – Straight

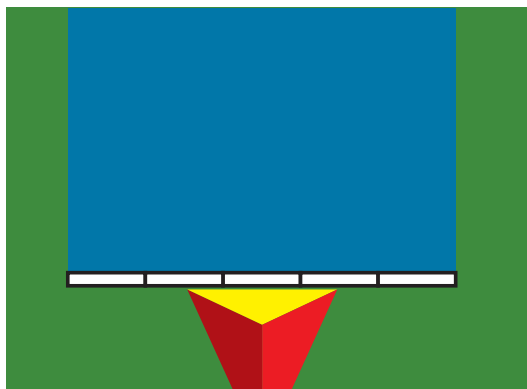

Figure 4-4: Implement type – Spreader

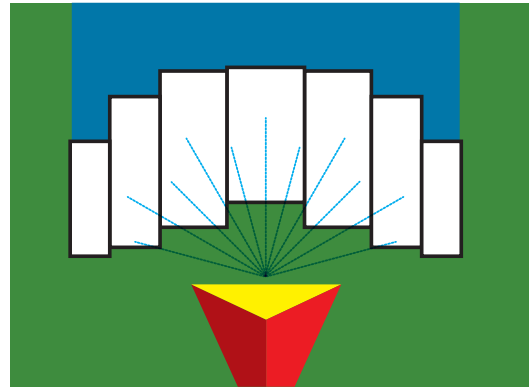



Figure 4-5: Implement type – Staggered



Single section setup

Single section setup is used when a SmartCable, Section driver module (SDM), or Switch function module (SFM) is not on the system (that is, no section control is present). The entire boom or delivery area is considered to be one section.

1. Press CONFIGURATION side tab .
2. Press **Implement**.
3. Select from:
 - ▶ Machine type [when available] – used to select the type of machine that most closely represents your machine
 - ▶ GNSS antenna height [when available] – used to measure the height of the antenna from the ground
 - ▶ Implement type – used to select the layout of the sections for the applied product location
 - ▶ Working width [Spreader implement type] – used to enter the total width of the implement
 - ▶ Application width [Straight implement type] – used to enter the total width of the implement
 - ▶ Droplet size monitor [when available] – used to enable droplet size monitoring for up to five preselected sprayer tips
 - ▶ Nozzle selection [when available] – used to select the type of sprayer nozzle (series and capacity) for determining droplet size information



- ▶ Applied alert – used to establish an alert to signal when exiting or entering an applied area
 - ▶ BoomPilot start mode – used to establish whether BoomPilot will be controlled by speed or by the BoomPilot icon
 - ▶ BoomPilot icon – used to activate the guidance screen icon for manually controlling on-screen application painting
4. Press NEXT PAGE arrow  to set up specific implement options. See the Implement chapter for details.
 5. Press RETURN arrow  or CONFIGURATION side tab  to return to the main Configuration screen.

Figure 4-6: Implement – Single section setup



Section(s) with ISOBUS sprayer/spreader setup

Some Implement options are completed on the ISOBUS ECU. When these options are also available in the Implement setup section, they will be greyed out or unavailable.





1. Press CONFIGURATION side tab .
2. Press **Implement**.
3. Select from:
 - ▶ Machine type [when available] – used to select the type of machine that most closely represents your machine
 - ▶ GNSS antenna height [when available] – used to measure the height of the antenna from the ground
 - ▶ Implement type – used to select the layout of the sections for the applied product location
 - ▶ Application width [Straight implement type completed on ISOBUS ECU] – used to display the total width of the implement as entered on the ISOBUS sprayer
 - ▶ Working width [Spreader implement type completed on the ISOBUS ECU] – used to display the total width of the implement as entered on the ISOBUS spreader
 - ▶ Droplet size monitor [available only with Pressure sensor interface kit] – used to enable droplet size monitoring for up to five sprayer tips
 - ▶ Nozzle selection [Straight implement type completed on the ISOBUS ECU] – used to display the type of sprayer nozzle as entered on the ISOBUS sprayer
 - ▶ Applied alert – [only available without a switchbox] used to establish an alert to signal when exiting or entering an applied area
 - ▶ BoomPilot start mode – used to control BoomPilot automatically by speed, or manually by BoomPilot icon
 - ▶ BoomPilot icon – used to activate icon for manually controlling BoomPilot
4. Press NEXT PAGE arrow  to set up specific implement options. See the Implement chapter for details.
5. Press RETURN arrow  or CONFIGURATION side tab  to return to the main Configuration screen.

Figure 4-7: Implement – with ISOBUS setup



Multiple sections with SDM/SFM setup

Multiple sections with SDM/SFM setup is used when a Section driver module (SDM) or switch function module (SFM) is on the system.

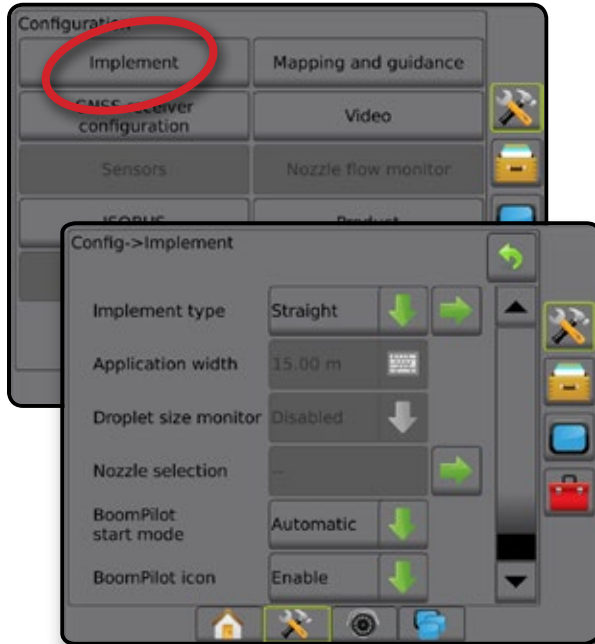
The boom or delivery area can include up to 15 sections of varying width and (in spreader mode) length. Additional options available with an SDM include application overlap, application delay, and staggered mode.

The Switch function module enables manual and automated control of up to 20 sections.

1. Press CONFIGURATION side tab
2. Press **Implement**.
3. Select from:
 - ▶ Machine type [when available] – used to select the type of machine that most closely represents your machine
 - ▶ GNSS antenna height [when available] – used to measure the height of the antenna from the ground
 - ▶ Implement type – used to select the layout of the sections for the applied product location
 - ▶ Symmetric implement – used to establish if sections are paired and therefore share the same width, offset, and length values
 - ▶ Multiple section output modules – used to enable use of multiple section output modules on the CAN bus
 - ▶ Number of implement sections – used to select the number of implement sections
 - ▶ Application width [Straight or Staggered implement type] – used to enter the total width of all sections of the implement

- ▶ Working width [Spreader implement type] – used to enter the total width of the implement
 - ▶ Droplet size monitor [when available] – used to enable droplet size monitoring for up to five preselected sprayer tips
 - ▶ Nozzle selection [Straight or Staggered implement type] – used to select the type of sprayer nozzle
4. Press NEXT PAGE arrow to set up specific implement options. See the Implement chapter for details.
 5. Press RETURN arrow or CONFIGURATION side tab to return to the main Configuration screen.

Figure 4-8: Implement – Multiple sections with SDM or SFM setup

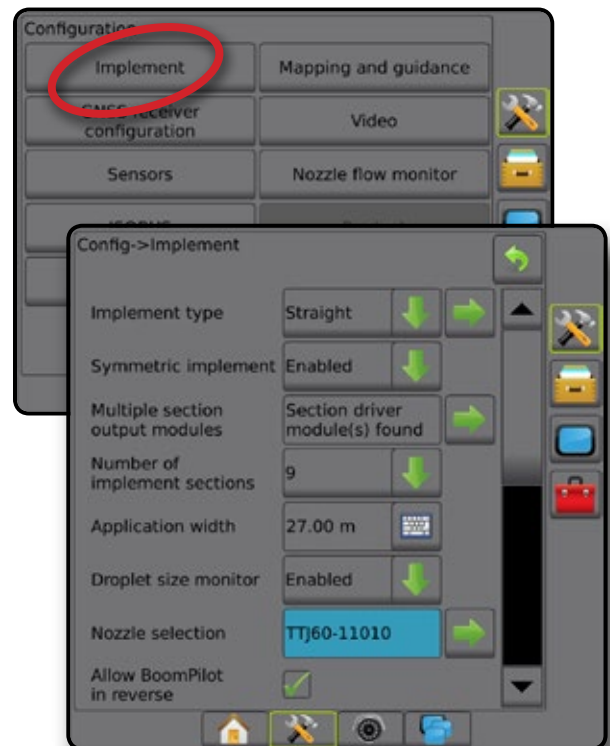

Droplet size monitor

When the system includes a Pressure sensor interface kit (PSIK), Droplet size monitor can be enabled/disabled. The DSM then becomes available on the operation screens.

NOTE: For more information, see "Droplet size monitor" in the Implement chapter of this manual.



1. Press CONFIGURATION side tab .
2. Press **Implement**.
3. Select if Droplet size monitor is enabled or disabled. (If enabling, also read displayed information and press **Accept**.)
4. Press RETURN arrow  or CONFIGURATION side tab  to return to the main Configuration screen.

Figure 4-9: Droplet size monitor



Nozzle selection

Nozzle selection enables up to five (5) tips to be preset for quick recall, and the current nozzle to be selected.

NOTE: For more information, see "Nozzle selection" in the Implement chapter of this manual.





1. Press CONFIGURATION side tab .
2. Press **Implement**.
3. Press Nozzle selection NEXT PAGE arrow .
4. Select from:
 - ▶ Nozzle preset 1-5 – selects up to five (5) tips for quick recall, and selected the current nozzle for determining droplet size information
 - ▶ Current nozzle – displays the current nozzle
5. Press RETURN arrow  or CONFIGURATION side tab  to return to the main Configuration screen.

Figure 4-10: Nozzle selection



Reverse sense options

Reverse sense options are used when adding a Reverse sense module or SCM Pro (Steering control module Pro for FieldPilot Pro/UniPilot Pro) to any configuration.. This allows for application mapping and control, and on-screen guidance when traveling in reverse.

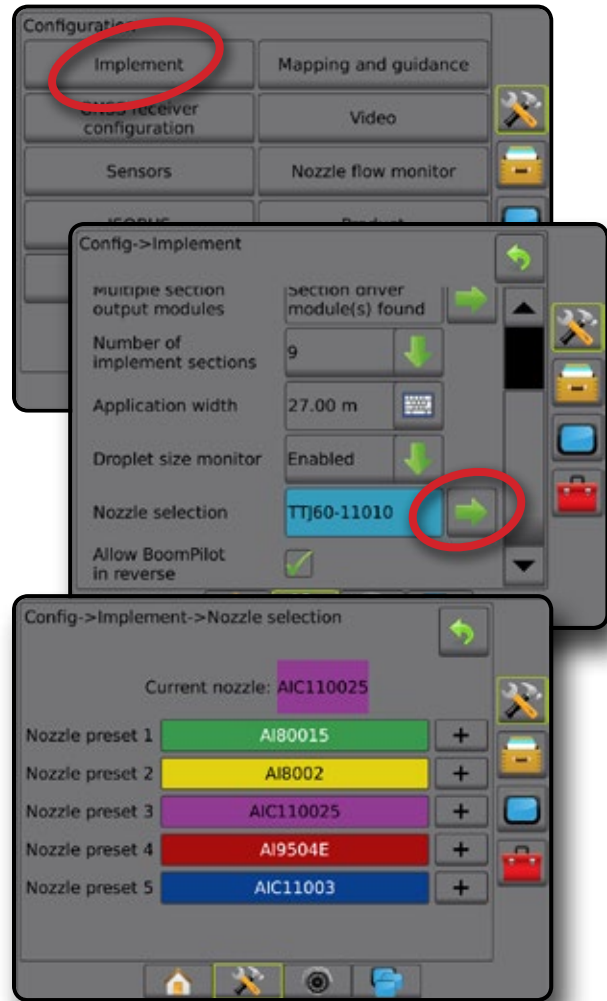
NOTE: For more information, see "Reverse sense" in the Implement chapter of this manual.



1. Press CONFIGURATION side tab .
2. Press **Implement**.
3. Select:
 - ▶ Allow BoomPilot in reverse [when available] – used to enable BoomPilot function while traveling in reverse
 - ▶ Reverse signal delay – used to set the delay when going from forward to reverse or reverse to forward, after which the vehicle icon on a navigation screen changes direction
4. Press RETURN arrow  or CONFIGURATION side tab  to return to the main Configuration screen.

Figure 4-11: Reverse sense



Mapping and guidance

Mapping and guidance options are used to configure the mapping location, guidance width, guidance sensitivity (cross track error) and/or an optional external lightbar module (ELM).

- Mapping and guidance [console only] – used to configure the mapping location, guidance width and guidance sensitivity/cross track error shown on the on screen guidance bar
- Mapping and guidance [using an external lightbar] – used to configure an optional external lightbar module (ELM) which provides additional guidance information.

Figure 4-12: Mapping and guidance

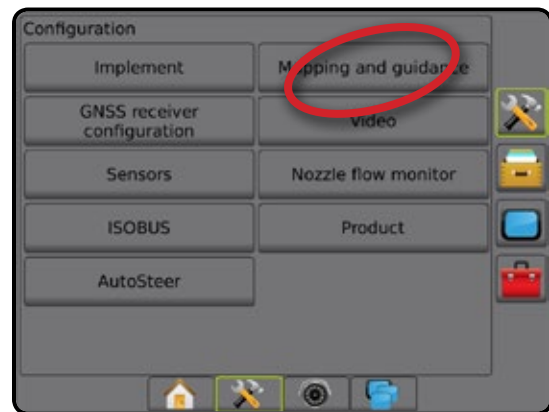

Mapping and guidance [console only]



1. Press CONFIGURATION side tab .
2. Press **Mapping and guidance**.
3. Select:
 - ▶ Mapping location – establishes the location from which the boundary or polygon will be mapped.
 - Default location – While creating an exterior boundary or polygon, the line will be to the exterior of the outermost active section. While creating an interior boundary, the line will be to the interior of the innermost active section. If no sections are active, the boundary will be marked to the end of the outermost section.
 - User entry – in-line and lateral offset from the GNSS antenna directions and distances can be specified by the user. Up to five (5) user entries can be created. See "User entered mapping location" for details.
 - ▶ Guidance width – used to set the distance between guidelines
 - ▶ Guidance sensitivity – sets the distance around the guideline that is perceived as zero error.
4. Press RETURN arrow  or CONFIGURATION side tab  to return to the main Configuration screen.

Figure 4-13: Mapping and guidance



Mapping and guidance using an external lightbar

Additional configuration options are available when using an external lightbar.

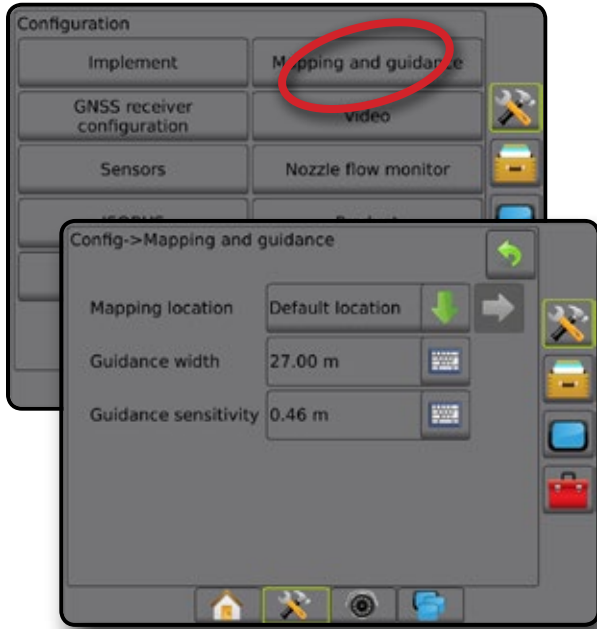



1. Press CONFIGURATION side tab .
2. Press **Mapping and guidance**.
3. Select from:
 - ▶ Mapping location – establishes the location from which the boundary or polygon will be mapped.
 - Default location – While creating an exterior boundary or polygon, the line will be to the exterior of the outermost active section. While creating an interior boundary, the line will be to the interior of the innermost active section. If no sections are active, the boundary will be marked to the end of the outermost section.
 - User entry – in-line and lateral offset from the GNSS antenna directions and distances can be specified by the user. Up to five (5) user entries can be created. See "User Entered Mapping Location" for details.
 - ▶ Guidance width – used to set the distance between guidelines
 - ▶ Display mode – when External lightbar is "enabled", determines whether the lightbar represents the swath or vehicle
 - When set to "swath", the LEDs represent guideline location and the moving LED represents the vehicle
 - When set to "vehicle", the center LED represents vehicle location and the moving LED represents the guideline
4. With the External lightbar module (ELM) enabled, select from:
 - ▶ External lightbar LED Brightness – adjusts the brightness of the external lightbar LEDs
 - ▶ External lightbar text brightness – adjusts the brightness of the external lightbar text
 - ▶ External cross track – enable/disable display of cross track error information on the external lightbar
 - ▶ External swath number – enable/disable display of swath number information on the external lightbar
 - ▶ External speed – enable/disable display of speed information on the external lightbar
 - ▶ External actual rate [available with rate control] – enable/disable display of actual rate information on the external lightbar
 - ▶ External target rate [available with rate control] – enable/disable display of target rate information on the external lightbar.
 - ▶ External applied product [available with rate control] – enable/disable display of applied product information on the external lightbar
5. Press RETURN arrow  or CONFIGURATION side tab  to return to the main Configuration screen.

Figure 4-14: Mapping and guidance with external lightbar



User entered mapping location

Mapping location establishes the location from which boundary and polygon mapping will take place.

1. Press CONFIGURATION side tab .
2. Press **Mapping and guidance**.
3. Select user entry location from the Mapping Locations drop-down options.
4. Press MAPPING LOCATION NEXT PAGE arrow  to set up the selected specific mapping location options.
5. Select:
 - ▶ Location name – used to enter the name of the mapping location for the current user entry selected
 - ▶ Mapping location in-line offset direction – used to select whether the mapping location is located in front of or behind the GNSS antenna as the vehicle moves in a forward direction
 - ▶ Mapping location in-line offset distance – used to define the in-line distance from the GNSS antenna to the mapping location
 - ▶ Mapping location lateral offset direction – used to select the lateral direction from the centreline of the machine to

the mapping location while facing in the machine's forward direction

- ▶ Mapping location lateral offset distance – used to define the lateral distance from the centreline of the machine to the mapping location



6. Press RETURN arrow  to return to the Mapping and Guidance screen or CONFIGURATION side tab  to return to the main Configuration screen.

Figure 4-15: User entered mapping location



Aeros 9040 field computer

INTRODUCTION

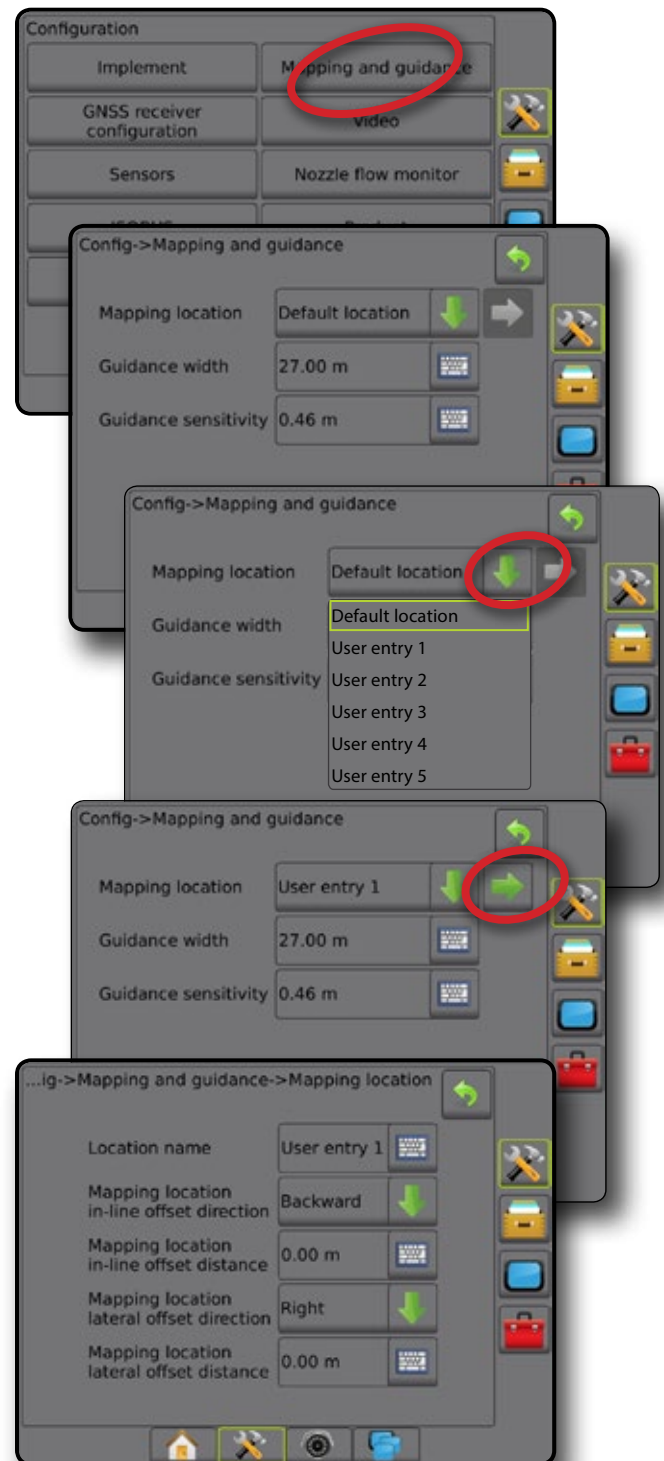
HOME

FULL SCREEN

SETUP

GNSS

IMPLEMENT

GUIDANCE

RATE CONTROL

APPENDIX

GNSS

GNSS is used to configure GNSS type, GNSS port, and PRN, as well as to view GNSS status information.

NOTE: For more information, see the GNSS chapter of this manual.

These settings are required for assisted/auto steering, tilt sensor operation, and rate control functionality, as well as proper implement operation.

1. Press CONFIGURATION side tab .
2. Press **GNSS receiver configuration**.
3. Select from:
 - ▶ GNSS type – sets to accept GNSS source transmissions: GPS, GLONASS, SBAS (with or without DGPS required)
 - ▶ GNSS port – sets GNSS communication port to either internal or external
 - ▶ GNSS status information – displays current GNSS status information
 - ▶ Program – only TeeJet support technicians should use this feature
 - ▶ PRN – selects the first of two possible SBAS PRN's to provide SBAS correction data. Set to **Automatic** for automatic PRN selection.
 - ▶ Alternate PRN – when PRN is not automatic, allows possible selection of a second SBAS PRN to provide correction data
 - ▶ Show refresh GNSS position button – establishes if the refresh GNSS position button is available on the guidance screens.

NOTE: Activating the refresh while in a job will cause a momentary interruption in the relay of GNSS data. This will most likely result in sections already on in automatic BoomPilot mode to go off for a short period of time.

The refresh should not be done during active application.



4. Press NEXT PAGE arrow  to set up the selected specific GNSS options.
5. Press RETURN arrow  or CONFIGURATION side tab  to return to the main Configuration screen.

Figure 4-16: GNSS options



PRN not shown

PRN options are only available with SBAS GNSS type selected.

Video

Video setup is used to set up a single directly connected camera or individual cameras while using an eight (8) channel or four (4) channel Video selector module (VSM). Up to 8 cameras can be configured if a VSM is installed.

1. Press CONFIGURATION side tab .
2. Press **Video**.
3. Select the appropriate check box(es):
 - ▶ Reverse – **ABC**
 - ▶ Upside down – **VBC**



For normal video view **ABC** un-check all check boxes.
4. Press RETURN arrow  or CONFIGURATION side tab  to return to the main Configuration screen.

Figure 4-17: Video with 4 channel VSM options



Video setup unavailable

If a camera or VSM is not connected, setup options will not be available.

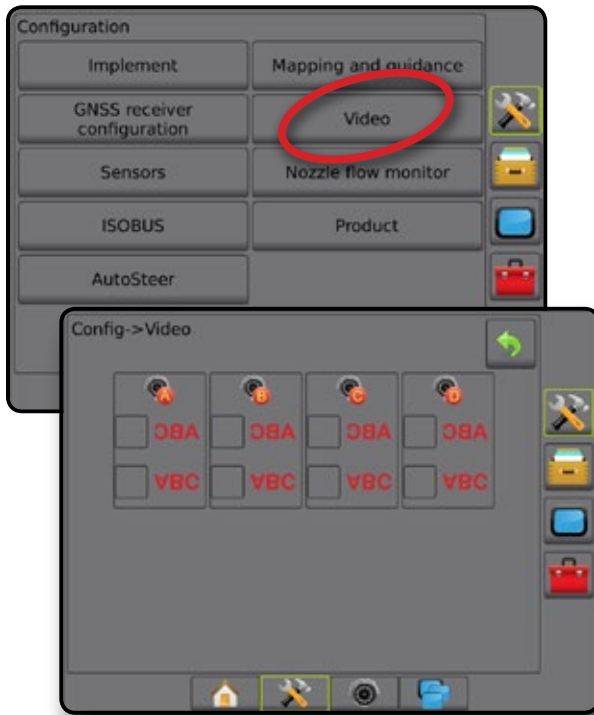
Sensors

When a Pressure sensor interface kit (specifically, an Input output module (IOM)) is on the system, options to set up and configure the sensor will be available.

1. Press CONFIGURATION side tab .
2. Press **Sensors**.

Figure 4-18: Sensors

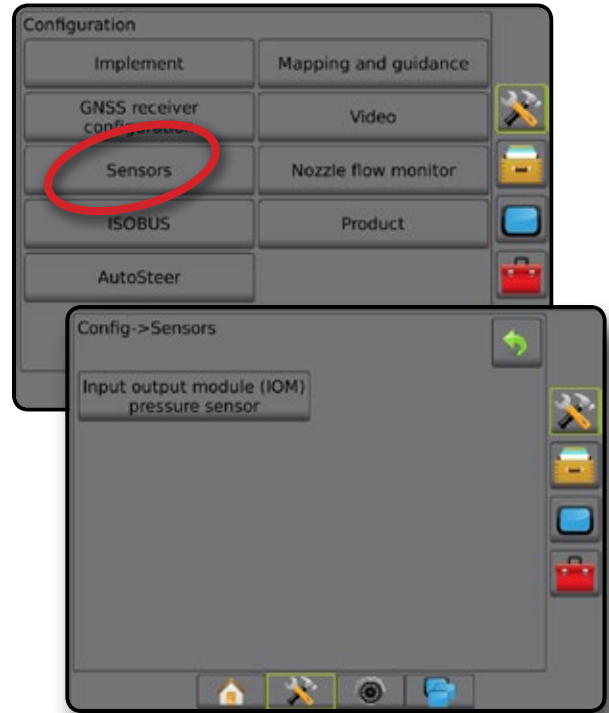

The Pressure sensor interface kit is recognized on the console about screen as an Input/output module (IOM).

Figure 4-19: Input/output module

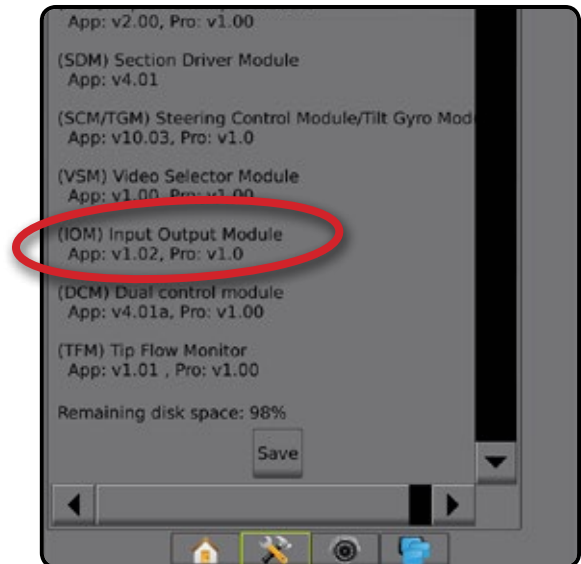

Sensors unavailable

If a Pressure sensor interface kit is not installed, setup options will not be available.

Input/output module pressure sensor

When a Pressure sensor interface kit is present, pressure sensor options are used to enter the sensor manufacture's maximum pressure rating and set high and low user determined pressure alarms.



1. Press CONFIGURATION side tab .
2. Press **Sensors**.
3. Press **Input output module (IOM) pressure sensor**.
4. Select from:
 - ▶ Maximum pressure rating – used to establish the maximum pressure rating of the pressure sensor as recommended by the manufacturer
 - ▶ Low pressure alarm – used to enter the user determined low pressure point at which the alarm will sound
 - ▶ High pressure alarm – used to enter the user determined high pressure point at which the alarm will sound
5. Press RETURN arrow  or CONFIGURATION side tab  to return to the main Configuration screen.

Figure 4-20: Input/output monitor pressure sensor options



Droplet size monitor

If a Pressure sensor interface kit is being used, the Droplet size monitor options will be available.

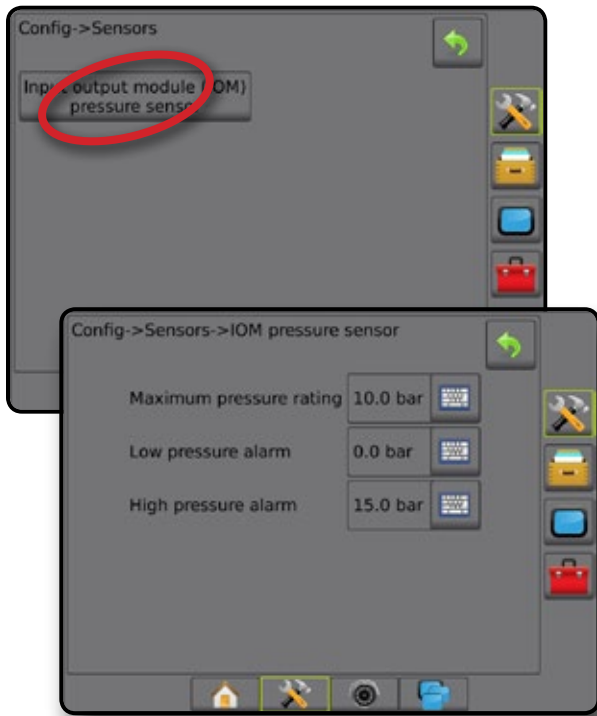

1. Press CONFIGURATION side tab .
2. Press **Implement**.
3. Press **Droplet size monitor**.
4. Select if droplet size monitor is enabled or disabled.
5. Press RETURN arrow  or CONFIGURATION side tab  to return to the main Configuration screen.

Figure 4-21: Droplet size monitor



Nozzle flow monitor

When a nozzle flow monitor kit is present, nozzle flow monitor options are used to configure flow limits and alarm behavior, and to run the nozzle flow balance process.

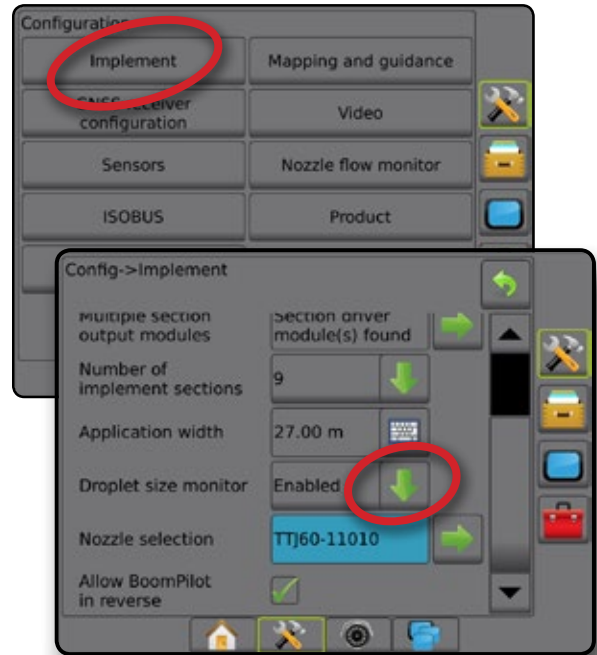
NOTE: For detailed setup instructions, refer to the supplemental Nozzle flow monitor (TFM) guide.

1. Press CONFIGURATION side tab .
2. Press **Nozzle flow monitor**.
3. Select from:
 - ▶ Nozzle alarm percentage – used to set the error reporting range for the nozzle sensors
 - ▶ Nozzle alarm delay – used to set the time the console will wait after an error has been encountered before sounding a nozzle alarm
 - ▶ Number of sections – used to set the number of sections
 - ▶ Number of tips per section – used to enter the number of tips on the specified section
 - ▶ Nozzle balance percentage – used to set the range for balancing nozzle sensors

NOTE: The implement must be in a job and all sections must be on to start the nozzle balance process.





- ▶ Nozzle flow monitor balance – used to start the nozzle flow balance process
4. Press RETURN arrow  or CONFIGURATION side tab  to return to the main Configuration screen.

Figure 4-22: Nozzle flow monitor options

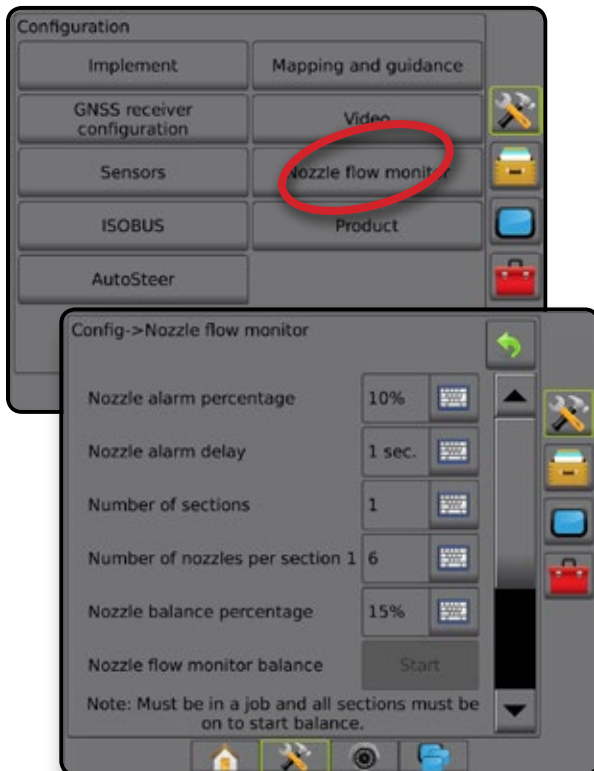

ISOBUS

When ISOBUS is in use, the ISOBUS page is used to select information for broadcast over the ISOBUS, and to verify specific information in troubleshooting.

1. Press CONFIGURATION side tab .
2. Press **ISOBUS**.
3. Select from:
 - ▶ Machine speed broadcast – used to broadcast speed information provided by the machine over the ISOBUS
 - ▶ Navigation speed broadcast – used to broadcast speed information provided by the machine over the ISOBUS
 - ▶ Ground speed broadcast – used to establish if the GNSS speed shall be broadcast as Ground based speed on the ISOBUS from this console.
 - ▶ Time/date broadcast – used to broadcast time and date over the ISOBUS

NOTE: Normally these shall be enabled, but if an alternative speed source shall be used, then it might be required to disable the GNSS speed, to ensure that the alternative speed source will be used by the ISOBUS controllers.



- ▶ Press RETURN arrow  or CONFIGURATION side tab  to return to the main Configuration screen.

Figure 4-23: ISOBUS options



Aeros 9040 field computer

INTRODUCTION
HOME
FULL SCREEN
SETUP
GNSS
IMPLEMENT
GUIDANCE
RATE CONTROL
APPENDIX

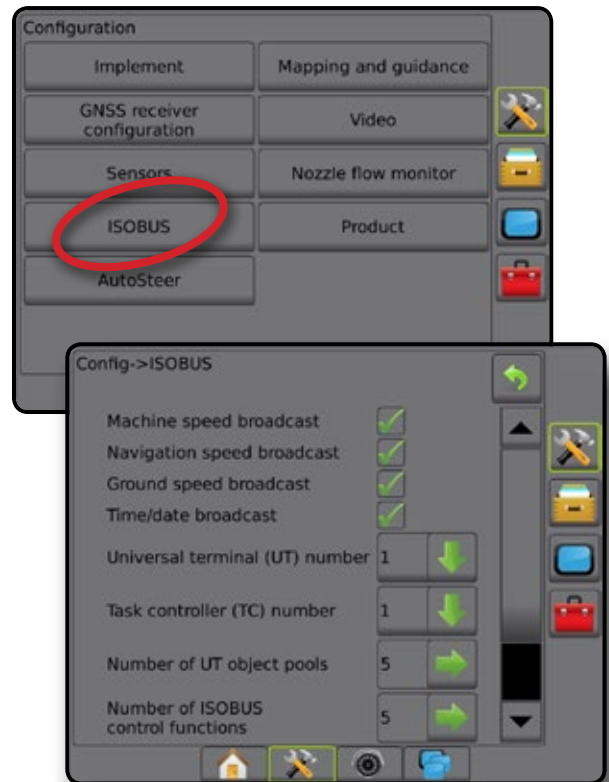
The following items on the ISOBUS page are for use **only** by TeeJet support technicians.

- ▶ Universal terminal (UT) Number [support technicians only] – used to define the unique number for this specific UT
- ▶ Task controller (TC) Number [support technicians only] – used to define the unique number for this specific TC
- ▶ Number of UT object pools [support technicians only] – shows the number of UT object pools are currently stored in the console
- ▶ Number of ISOBUS control functions [support technicians only] – shows the number of ISOBUS control functions communicating on the ISOBUS

Figure 4-24: ISOBUS options

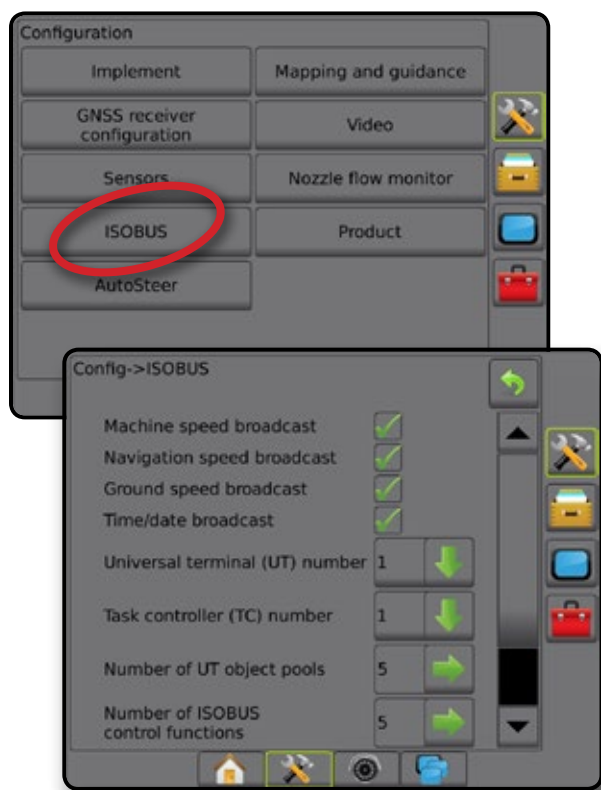

Product

When an ISOBUS rate control system is present, Product options are available for configuring product control channel names, product volumes, application rates, increment for adjusting rates, and maximum/minimum rate limits and corresponding display colours for mapping.

NOTE: For more information, see the Rate control chapter of this manual.

1. Press CONFIGURATION side tab
2. Press **Product**.
3. Select from:
 - ▶ Product name – used to enter the name of the product for the current Control Channel
 - ▶ Maximum/minimum rate colour – used to create the colour scheme that best represents the change in rates across an application or target rate map
 - ▶ Color range – used to select automatic or manual mode for setting maximum and minimum rate colour
 - ▶ Applied rate mapping upper limit [Manual colour range only] – used to set the maximum rate for which the Maximum rate colour will be used (higher rates will use the selected Maximum rate colour)
 - ▶ Applied rate mapping lower limit [Manual colour range only] – used to set the minimum rate for which the Minimum rate colour will be used (lower rates will use the selected Minimum rate colour)

Figure 4-25: Product options



AutoSteer

When a steering control module (SCM or SCM Pro) is present, assisted/auto steering options will be available.

NOTE: For detailed setup instructions, refer to your specific assisted/auto steering installation manual.

AutoSteer setup is used to enable/disable and calibrate assisted/auto steering

- FieldPilot [using a SCM] – used to establish valve setup settings, steering settings, steering wheel and steering angle sensor settings, and to perform valve tests or valve diagnostics
- FieldPilot Pro / UniPilot Pro [using a SCM Pro] – used to manage vehicle settings, calibrate sensors, select QI values, as well as establish transport mode and service mode

Assisted/auto steering unavailable

If an assisted/auto steering system is not installed, setup options will not be available.

FieldPilot [using a SCM]







1. Press CONFIGURATION side tab .
2. Press **AutoSteer**.
3. Select if assisted/auto steering is enabled or disabled.
4. When enabled, select from:
 - ▶ Valve setup – used to configure valve type, valve frequency, minimum duty cycle left/right and maximum duty cycle left/right
 - ▶ Steering settings – used to establish coarse steering adjustment, fine steering adjustment, deadband, and lookahead
 - ▶ Valve test – used to verify if steering is directed correctly
 - ▶ Valve diagnostics – used to test the valves to see if they are connected properly
 - ▶ Options: Steering wheel sensor – used to select whether the steering disengage sensor is magnetic or pressure sensor based
 - ▶ Steering angle sensor – used to establish and calibrate the steering angle sensor (SAS) as the primary feedback sensor for auto steering
5. Press RETURN arrow  or CONFIGURATION side tab  to return to the main Configuration screen.

Figure 4-26: AutoSteer



FieldPilot Pro / UniPilot Pro [using a SCM Pro]

1. Press CONFIGURATION side tab .
2. Press **AutoSteer**.
3. Select from:
 - ▶ Manage vehicles – allows the operator to select, edit, copy, delete, or export/import vehicle profiles as well as
 - NOTE: When creating a new vehicle profile or editing an existing vehicle profile, manual disengage should be set up before doing the automatic calibration.*
 - ◀ New  – creates a new vehicle profile.
 - ◀ Load – activates the highlighted vehicle profile.
 - ◀ Edit  – allows the operator to modify the parameters of the active vehicle profile including wheel base, antenna in-line offset direction & distance, antenna lateral offset direction & distance, antenna height, SCM Pro in-line offset direction & distance, SCM Pro lateral offset direction & distance, SCM Pro height, and SCM Pro orientation
 - ◀ Copy – duplicates the active vehicle profile
 - ◀ Automatic calibration  – guides the operator through the calibration process for the active vehicle. The calibration steps teach the FieldPilot Pro system or UniPilot Pro system the characteristics of the vehicle and the steps are critical to achieve optimal control performance.

◀ Adjust – after the vehicle has been calibrated, it should perform adequately for most normal field operations. However in some situations, it may be necessary to adjust the steering performance to take into account field conditions, implement selection, traveling speed, etc. The Vehicle Adjust screen enables the operator to adjust the vehicle steering performance to match these changing conditions.

- Manual disengage **2** – adjust the limit at which FieldPilot Pro or UniPilot Pro is disengaged when the steering wheel is being turned manually.

◀ Delete – allows the operator to delete a vehicle profile that is no longer needed. The active vehicle profile cannot be deleted.

- ▶ Select QI values – allows the user to configure the minimum GNSS position quality (precision level) requirements to allow FieldPilot Pro or UniPilot Pro to be activated and remain engaged
- ▶ Maximum DOP – Maximum DOP (dilution of precision) sets the maximum value of the overall quality of a GNSS position based on the satellite geometry that is used to calculate it. A value of 1 to 2 is excellent, 2-5 is good, 5-10 is moderate, 10-20 is fair, and anything over 20 is poor.

Assisted/automatic steering should be performed when the DOP is below 4 for best results.

- ▶ Transport mode – when enabled, all AutoSteer functions are disabled and cannot be activated.
- ▶ Service mode – when enabled, WiFi will be available through the next power cycle so a technician can connect to the SCM Pro directly for service tasks.
- ▶ Operator presence – set operator presence switch response
 - Enable – FieldPilot Pro or UniPilot Pro not possible with switch OPEN. Recommended setting regardless of presence/absence of operator presence switch.
 - Disable – operator presence detection has been deactivated and will not affect FieldPilot Pro or UniPilot Pro. This is a critical safety feature that should only be disabled when instructed by the machine manufacturer or TeeJet Technologies.



4. Press RETURN arrow  or CONFIGURATION side tab  to return to the main Configuration screen.

Figure 4-27: FieldPilot Pro or UniPilot Pro setup opening screen





Active vehicle

Active vehicle is highlighted with a set of asterisks (*). This is the vehicle profile the FieldPilot Pro system or UniPilot Pro system is currently programmed to use.

Tilt correction

When a Steering control module (SCM) or Tilt gyro module (TGM) is present, Tilt correction is available. This corrects the GNSS signal to compensate for errors in the GNSS position while operating on hilly or sloped terrain.

For detailed setup instructions, refer to your specific assisted/auto steering installation manual or tilt setup bulletin.

1. Press CONFIGURATION side tab .
2. Press **Tilt correction**.
3. Select if Tilt correction is enabled or disabled.
4. When enabled, select **Field level** to calibrate tilt correction.
5. Press RETURN arrow  or CONFIGURATION side tab  to return to the main Configuration screen.

NOTE: If FieldPilot or UniPilot is being used, a Tilt gyro module is built into the system. When using a FieldPilot Pro or UniPilot Pro, tilt correction is calibrated under Setup-> Configuration-> AutoSteer-> Manage vehicles-> Adjust-> Tilt calibration.

NOTE: Antenna height must be entered prior to tilt calibration.

Figure 4-28: Tilt Correction



Field level unavailable

If the vehicle is in motion, the field level option will not be available. Vehicle must be stopped for at least 10 seconds to begin to calibrate tilt correction.

Tilt correction unavailable

If an SCM or TGM is not connected, setup options will not be available. When using a FieldPilot Pro or UniPilot Pro, tilt correction is calibrated under Setup-> Configuration-> AutoSteer-> Manage vehicles-> Adjust-> Tilt calibration.



DATA MANAGEMENT

Data management allows for transfer and management of job data, reporting of job data, changing of job mode, and transfer and management of machine settings.

1. Press SYSTEM SETUP bottom tab
2. Press DATA MANAGEMENT side tab
3. Select from:
 - ▶ Job data – in advanced job mode, used to transfer job information (delete, import, export) and manage job information (create a new job, delete a job, or copy a job's guidelines, boundaries, applied data, prescription map and/or polygons to a new job)
 - ▶ Reports – used to create job reports and save them to a USB drive
 - ▶ Options – used to select simple job mode or advanced job mode
 - ▶ Machine settings – used to transfer machine settings (delete, import, export) and manage machine setting (create a new machine setting, copy a machine setting, delete a machine setting, save the current machine setting to the selected file, or load the selected file's machine setting)

Figure 4-29: Data management options

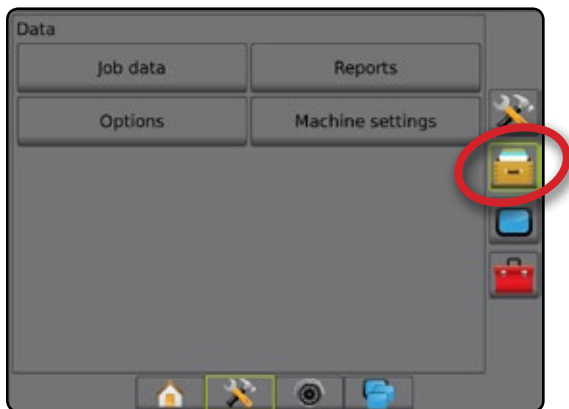

Job data

When in advanced job mode, job data options are used to transfer job information (delete, import, export) and manage job information (create a new job, delete a job, or copy a job's guidelines, boundaries, applied data, prescription map and/or polygons to a new job).

Job data includes:

- Job name
- Client, Farm, and Field names
- Boundary (exterior, interior)
- Polygons
- Coverage Area
- Guidelines
- Maps (coverage, prescription, application, preset target rate)
- Nozzle faults

1. Press DATA MANAGEMENT side tab
2. Press **Job data**
3. Select from:
 - ▶ Transfer – when in advanced job mode, allows the transfer of selected jobs to or from a USB drive, as well as deleting jobs
 - ▶ Manage – when in advanced job mode, allows the creation of a new empty job, copying of a selected job's guidelines, boundaries, applied data, prescription map and/or polygons to a new job, as well as deleting a selected job
4. Press RETURN arrow or DATA MANAGEMENT side tab to return to the main Data management screen.

Figure 4-30: Job data options

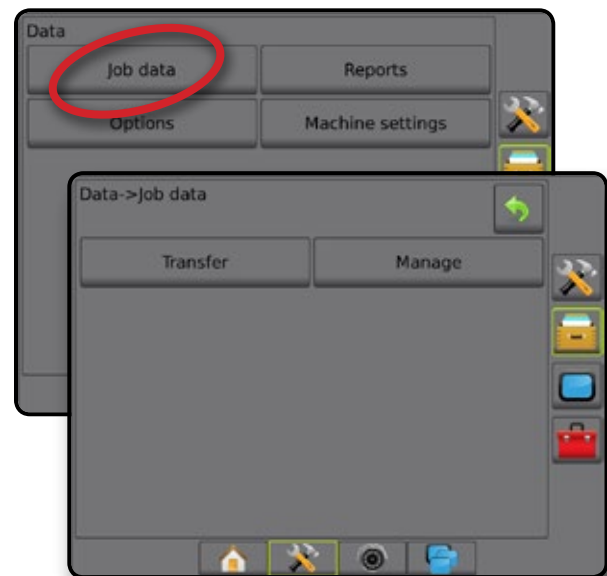

Job data unavailable

When in simple job mode, job data options will not be available.

Transfer

When in advanced job mode, the job data transfer screen allows the transfer of selected jobs to or from a USB drive, as well as deleting jobs.

Jobs transferred to a USB storage device can be opened and updated using Fieldware Link. In Fieldware Link a user can input client, farm and field data as well as copy/edit jobs for reuse of boundaries and guidelines. From Fieldware Link, jobs can be ported back to a USB storage device to be moved back onto the console internal storage for use.

NOTE: When a job is active/started, Transfer options are not available for selection. Stop the current job to enable the function.

Jobs transferred to a storage device are removed from the console and are no longer available for use.







1. Press DATA MANAGEMENT side tab .
2. Press **Job data**.
3. Press **Transfer**.
4. Select from:
 - ▶ Move Job data to USB storage  – used to move job data from internal storage to USB storage
 - ▶ Move Job data to Internal storage  – used to move job data from USB storage to internal storage
 - ▶ Delete Job data  – used to delete job data from internal storage
5. Press RETURN arrow  or DATA MANAGEMENT side tab  to return to the main Data management screen.

Figure 4-31: Job data – Transfer



Manage

When in advanced job mode, the job data manage screen allows the creation of a new empty job, copying of a selected job's guidelines, boundaries, applied data, prescription map and/or polygons to a new job, as well as deleting a selected job.

NOTE: When a job is active/started, Manage options are not available for selection. Stop the current job to enable the function.



1. Press DATA MANAGEMENT side tab .
2. Press **Job data**.
3. Press **Manage**.
4. Select from:
 - ▶ New – used to create a new empty job with no associated Guidelines, Boundaries, Applied Data, Prescription Map or Polygons
 - ▶ Copy – used to copy the selected job's guidelines, boundaries, applied data, prescription map and/or polygons into a new job
 - ▶ Delete – used to delete job data from internal storage
5. Press RETURN arrow  or DATA MANAGEMENT side tab  to return to the main Data management screen.

Figure 4-32: Job data – Manage



NOTE: Copying applied data is not recommended as the user will end up with two copies that can be changed. When backing up data, it is best to transfer the Job to Fieldware Link and make a backup of the catalog.

Aeros 9040 field computer

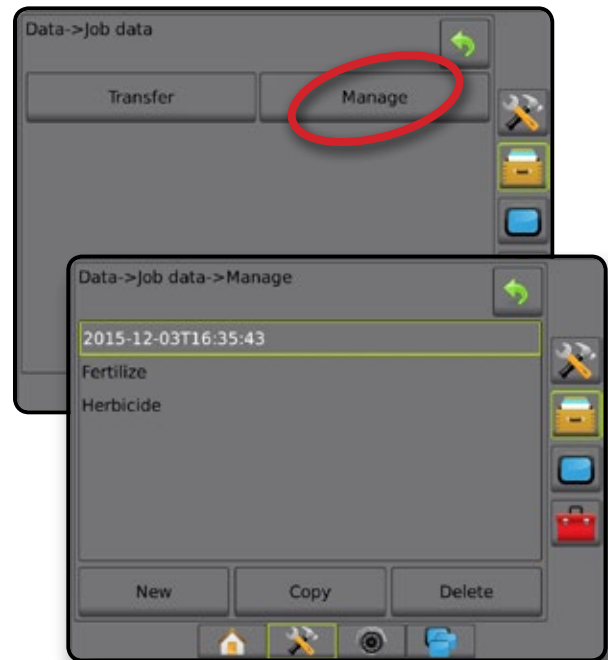
INTRODUCTION

HOME

FULL SCREEN

SETUP

GNSS

IMPLEMENT





GUIDANCE

RATE CONTROL

APPENDIX

Copy job data

When in advanced job mode, the copy job data option is used to duplicate job information (guidelines, boundaries, applied data, prescription map and/or polygons) to a new job.

1. Press DATA MANAGEMENT side tab .
2. Press **Job Data**.
3. Press **Manage**.
4. Select the job data from which job information is to be duplicated.
5. Press **Copy**.
6. Select the job's guidelines, boundaries, applied data, prescription map and/or polygons to be copied into a new job.
7. Press **Copy**.
8. Name the new job.
9. Press the ACCEPT icon  to save the new job or the CANCEL icon  to leave the keyboard without saving.
10. Press RETURN arrow  or DATA MANAGEMENT side tab  to return to the main Data management screen

NOTE: Copying applied data is not recommended as the user will end up with two copies that can be changed. Whne backuping up data, it is best to transfer the Job to Fieldware Link and make a backup of the catalog.

Figure 4-33: Job Data – Copy Data









Reports

Reports provides options for generating a report of the Job data in three different formats and save them to a USB drive.

NOTE: If Simple Job mode is selected in the Options page, only the current job can be saved.

When a job is active/started, Reports are not available for selection. Stop the current job to enable the function.

When closing a job with a USB drive in the console, you get the option to create a report on the current job.

1. Press DATA MANAGEMENT side tab .
2. Press **Reports**.
3. Insert a USB drive into the console.
4. Select the job to be saved.
5. Select:
 - ▶ PDF  – report for print
 - ▶ KML  – Google Earth map
 - ▶ SHP  – ESRI shape data
 - ▶ ALL  – all available file types
6. Press RETURN arrow  or DATA MANAGEMENT side tab  to return to the main Data management screen.





NOTE: The file icons     or buttons are not available for selection (grayed out) until a USB drive is inserted properly.

Figure 4-34: Reports – Advanced job mode

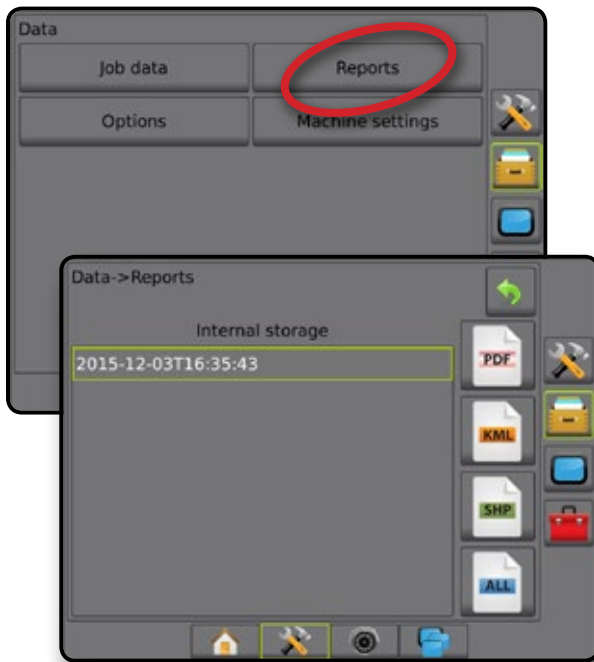
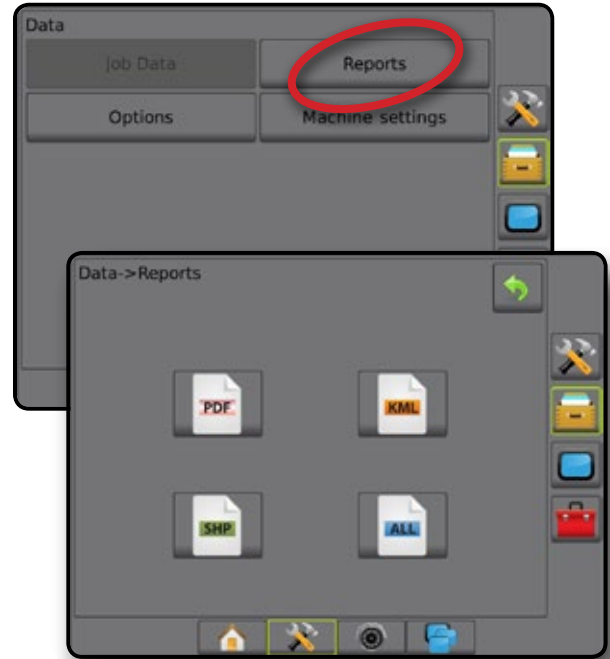

Figure 4-35: Reports – Simple job mode





Options (Job mode)

Options allows the operator to select between simple or advanced Job mode.

NOTE: When a job is active/started, changing the job mode is not available. Stop the current job to enable the function.

WARNING! Changing job modes deletes all internal job data.

1. Press DATA MANAGEMENT side tab .
2. Press **Options**.
3. Press DOWN arrow  to access the list of options.
4. Select:
 - ▶ Simple – only bounded area and coverage areas are displayed on the home screen. Only the current job is available for saving in Reports. Use with Fieldware Link is not available.
 - ▶ Advanced – more than one job will be available at any time. Client, farm, field and job names; bounded and coverage areas; application time; and distance from selected job are displayed on the home screen. All saved job profiles can be exported as a PDF, SHP or KML file to a USB drive using Data -> Reports.
 - Client information, farm information, field information, and prescription maps can only be inputted using Fieldware Link. A job name can only be edited using Fieldware Link.
 - A user can duplicate jobs for reuse of guidelines, boundaries, applied data, prescription map, and/or polygons using Fieldware Link or Data -> Job data -> Manage in the console.
5. "Changing job modes requires deleting all job data. Do you wish to change modes?"

Press:



 - ▶ Yes – to make the change
 - ▶ No – to keep the current setting
6. Press RETURN arrow  or DATA MANAGEMENT side tab  to return to the main Data management screen.

Figure 4-36: Options – Change Job mode



Machine settings

The Machine Settings menu is used to create and manage individual Machine Profiles representing the configuration of the console on a particular vehicle/equipment setup. Each Machine Profile records the settings in use at the time the profile is generated allowing the customer to recall their exact setup for later use. Machine Profiles can be used to transfer settings to another console of the same make and model with the same attached hardware.

Machine settings include:

- Implement settings
- AutoSteer/Tilt correction settings
- Rate control settings
- Job-specific settings (including application rates, application type, and product channel assignments)

NOTE: Not all settings are saved as part of the machine settings. See the appendix "Aeros console menu settings" for details.



1. Press DATA MANAGEMENT side tab .
2. Press **Machine settings**.
3. Select from:
 - ▶ Transfer – allows the transfer of selected machine settings to or from a USB drive, as well as deleting machine settings
 - ▶ Manage – allows the creation of a new empty machine settings, the copying of a selected machine settings to a new machine settings, the deletion of a selected machine settings, the saving of the current machine settings to the selected machine settings, or the loading of the selected machine settings to the current settings
4. Press RETURN arrow  or DATA MANAGEMENT side tab  to return to the main Data management screen.

Figure 4-37: Machine settings



Transfer

The machine settings transfer screen allows the transfer of selected machine settings to or from a USB drive, as well as deleting machine settings.

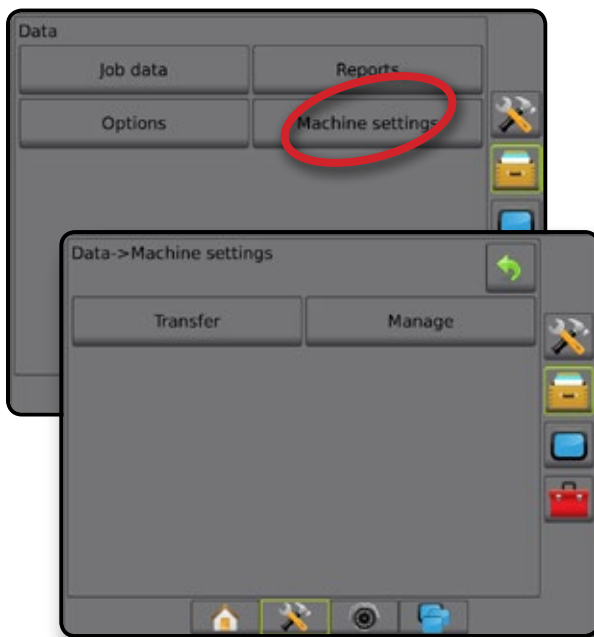
Machine settings transferred to a USB storage device can be opened and updated using Fieldware Link. From Fieldware Link, machine settings can be ported back to a USB storage device to be moved back onto the console internal storage for use.

NOTE: Not all settings saved as part of the machine settings are available to be edited in Fieldware Link. See the appendix "Aeros console menu settings" for details.

Machine settings transferred to a storage device are removed from the console and are no longer available for use.







1. Press DATA MANAGEMENT side tab .
2. Press **Machine settings**.
3. Press **Transfer**.
4. Select from:
 - ▶ Move Machine settings to USB storage  – used to move machine settings from internal storage to USB
 - ▶ Move Machine settings to Internal Storage  – used to move machine settings from USB to internal storage
 - ▶ Delete Machine settings  – used to delete machine settings from internal storage or USB storage
5. Press RETURN arrow  or DATA MANAGEMENT side tab  to return to the main Data management screen.

Figure 4-38: Machine settings – Transfer



Manage

The Machine settings Manage screen allows the creation of a new empty machine settings, the copying of a selected machine settings to a new machine settings, the deletion of a selected machine settings, the saving of the current machine settings to the selected machine settings, or the loading of the selected machine settings to the current settings.

NOTE: Not all settings are saved as part of the machine settings.
See the appendix "Aeros console menu settings" for details.



1. Press DATA MANAGEMENT side tab .
2. Press **Machine settings**.
3. Press **Manage**.
4. Select from:
 - ▶ New – used to create a new machine setting with no associated implement information
 - ▶ Copy – used to copy a selected machine settings into a new machine settings
 - ▶ Delete – used to delete a selected machine settings from internal storage
 - ▶ Save – used to save the current machine settings to the selected machine settings
 - ▶ Load – used to load the selected machine settings to the current settings
5. Press RETURN arrow  or DATA MANAGEMENT side tab  to return to the main Data management screen.

Figure 4-39: Machine settings – Manage



Copy machine profile

The copy machine profile option is used to duplicate the selected machine profile for recall of that profile at a later use. Machine profiles can be used to transfer settings to another console of the same make and model with the same attached hardware.





1. Press DATA MANAGEMENT side tab .
2. Press **Machine settings**.
3. Press **Manage**.
4. Select the machine profile to be copied into a new profile.
5. Press **Copy**.
6. Name the new profile.
7. Press the ACCEPT icon  to save the new profile or the CANCEL icon  to leave the keyboard without saving.
8. Press RETURN arrow  or DATA MANAGEMENT side tab  to return to the main Data management screen

Figure 4-40: Machine settings – copy profile



CONSOLE

Console setup is used to configure the display and cultural settings, unlock advanced features, and play back demo GNSS data. Information about other devices attached to the system can be found in the About section.



1. Press SYSTEM SETUP bottom tab .
2. Press CONSOLE side tab .
3. Select from:
 - ▶ About – used to display the system software version as well as the software versions of modules connected to the CAN bus
 - ▶ Display – used to configure colour scheme and LCD brightness, establish screenshot availability, and calibrate the touchscreen
 - ▶ Cultural – used to configure units, language, and time zone settings
 - ▶ Audio Volume – used to adjust the volume level of the audio speaker
 - ▶ Demo GNSS – used to start playback of simulated GNSS data
 - ▶ Feature Unlock – used to unlock advanced features



Figure 4-41: Console options

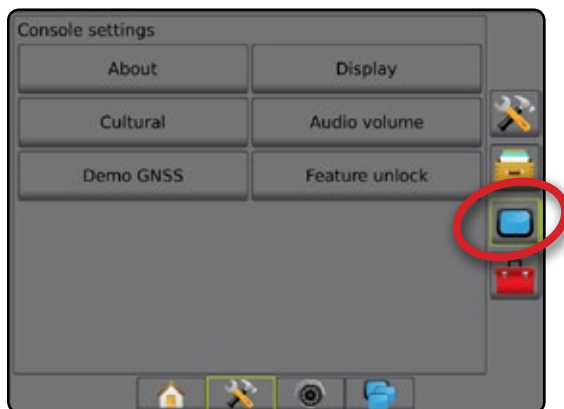

About

About/Save screen displays the system software version as well as the software versions of modules connected to the CAN bus.

To aid when troubleshooting problems in the field, an end user can use the Save button to download a text file containing current software information to a USB drive, then e-mail the file to support personnel.

1. Press CONSOLE side tab .
2. Press **About**.
3. Select from:
 - ▶ View Information including unit serial number, software version, and connected modules
 - ▶ With a USB drive in the console, press **Save** to save the About information to the USB drive. Saved version information to USB drive will confirm the save.
4. Press RETURN arrow  or CONSOLE side tab  to return to the main Console settings screen.

*NOTE: The **Save** option is not available for selection (grayed out) until a USB drive is inserted properly.*

Figure 4-42: About options



Display

Display is used to configure colour scheme and LCD brightness, establish screenshot availability and calibrate the touchscreen.



1. Press CONSOLE side tab .
2. Press **Display**.
3. Select from:
 - ▶ Color scheme – used to choose the colour scheme that is easiest to read
 - ▶ LCD brightness – used to adjust the brightness of the console display
 - ▶ Screenshot – used to allow screen captures to be saved to a USB drive
 - ▶ Screen calibration – used to calibrate the touch screen
4. Press RETURN arrow  or CONSOLE side tab  to return to the main Console settings screen.

Figure 4-43: Display options



Cultural

Cultural is used to configure units, language, and time zone settings for the Aeros console and any Electronic control units (ECUs) in the system.

NOTE: The languages available in a particular ECU may vary.



1. Press CONSOLE side tab .
2. Press **Cultural**.
3. Select from:
 - ▶ Units – used to define the system units
 - ▶ Language – used to define the system language
 - ▶ Time zone – used to establish the local time zone
4. Press RETURN arrow  or CONSOLE side tab  to return to the main Console settings screen.

Figure 4-44: Cultural options



Audio volume

Audio volume adjusts the volume level of the audio speaker.

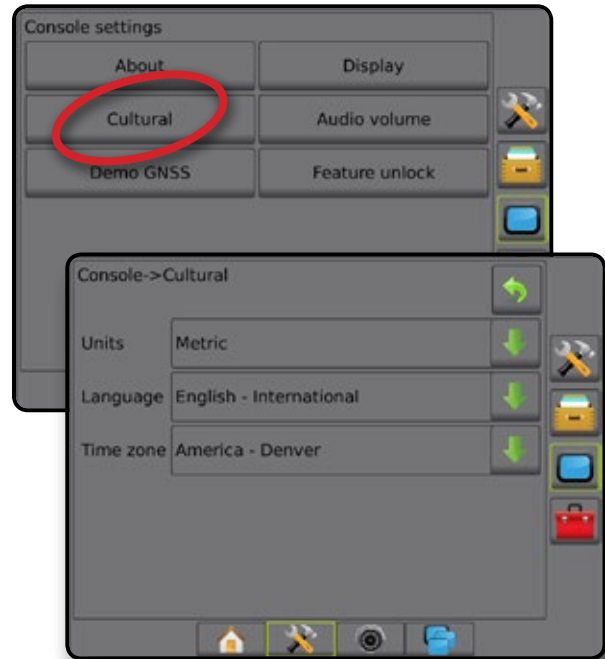



1. Press CONSOLE side tab .
2. Press **Audio volume**.
3. Press:
 - ▶ UP arrow  to increase the sound
 - ▶ DOWN arrow  to soften the sound
4. Press RETURN arrow  or CONSOLE side tab  to return to the main Console settings screen.



Figure 4-45: Audio volume options

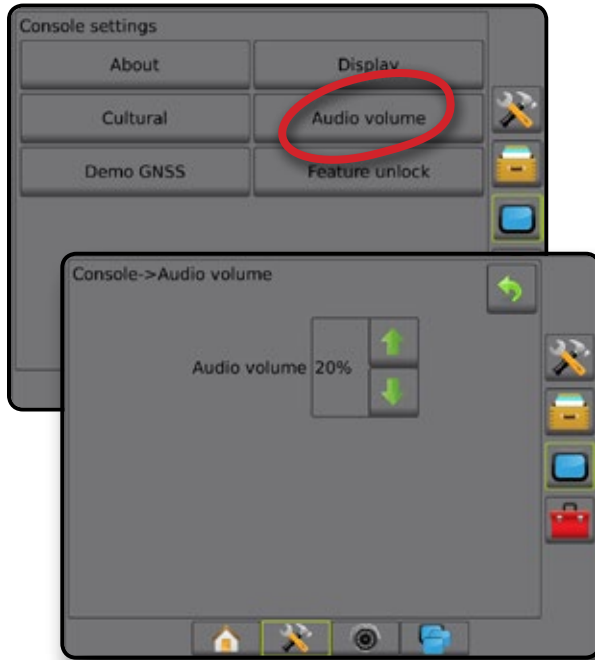

Demo GNSS

Demo GNSS is used to start the playback of a simulated GNSS signal.

WARNING! This tool will disable incoming GNSS positions and begin playing back simulated data. A console reboot is necessary in order to restore real GNSS.

1. Press CONSOLE side tab .
2. Press **Demo GNSS**.
3. Press **Start**.
4. Press RETURN arrow  or CONSOLE side tab  to return to the main Console settings screen.

NOTE: A console reboot is necessary in order to restore a real GNSS.

Figure 4-46: Demo GNSS



Restart Demo GNSS

Demonstration GNSS can be restarted.



1. Press CONSOLE side tab .
2. Press **Demo GNSS**.
3. Press **Restart**.
4. Press RETURN arrow  or CONSOLE side tab  to return to the main Console settings screen.

Figure 4-47: Restart Demo GNSS



Feature unlock

Feature unlock is used to unlock advanced features.

NOTE: The unlock code is unique for each console. Contact TeeJet Technologies customer service. Once unlocked, a feature remains unlocked unless the console is fully reset.



1. Press CONSOLE side tab .
2. Press **Feature unlock**.
3. Press the locked feature button  for the locked feature:
 - ▶ BoomPilot for spreader – allows for spreader application options when used with a compatible spreader implement
 - ▶ FieldPilot Pro / UniPilot Pro – allows for AutoSteer options when using a SCM Pro
4. Enter unlock code if required.
5. Restart the console.

Figure 4-48: Feature Unlocked



TOOLS

Tools is used to upload software updates for system devices, and to do various calculations on a regular calculator or a unit converter.

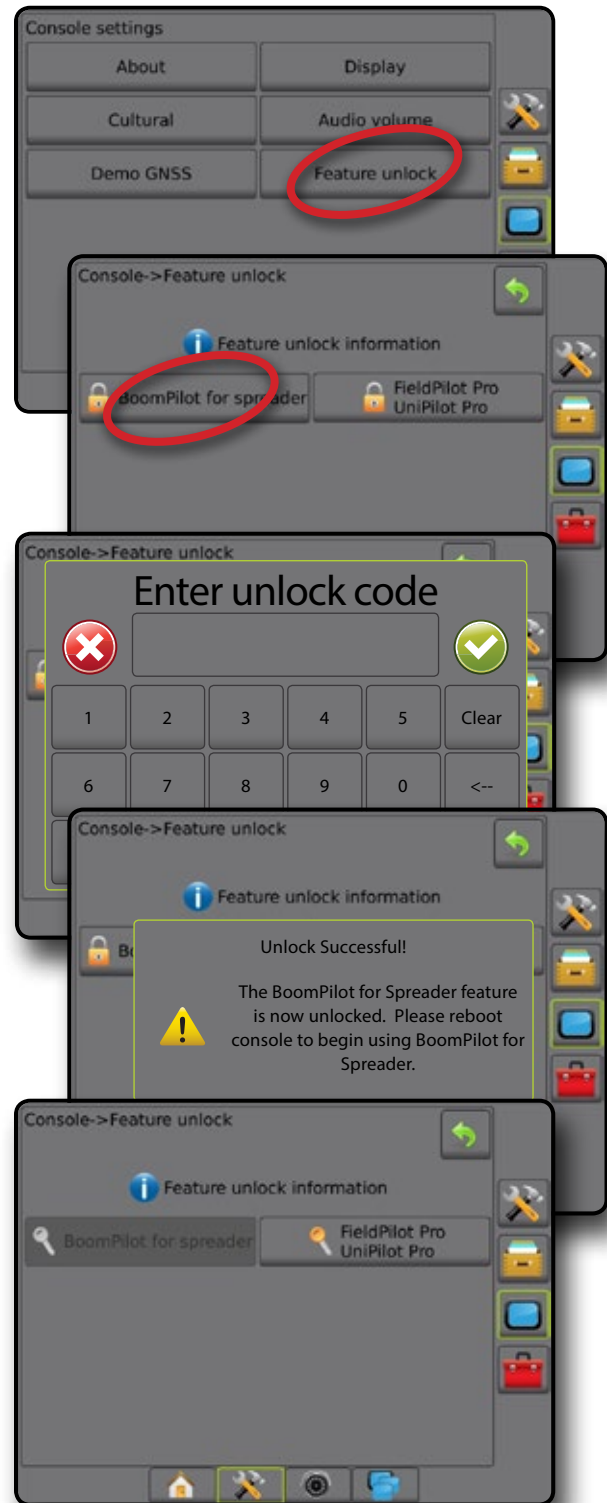

1. Press SYSTEM SETUP bottom tab .
2. Press TOOLS side tab .
3. Select from:
 - ▶ Upload software – used to upload software updates from a USB drive for system devices.
 - ▶ Extras – accesses Calculator and Units converter

Figure 4-49: Tools options



Upload software

The Upload software screen is used to upload software updates from a USB drive for system devices.

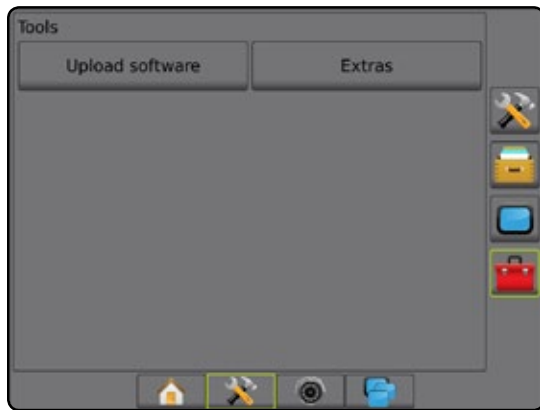



1. Press TOOLS side tab .
2. Press **Upload software**.
3. Insert the USB drive containing software updates into the console.
4. Press Device DOWN arrow  and select the device for which software will be updated:
5. Press Software DOWN arrow  and select the software update to be uploaded to the device.
6. Press **Begin upload**.
7. When prompted, press **OK**.
8. Press RETURN arrow  to return to the Tools screen, or press CONSOLE side tab  to return to the main Console settings screen.

Figure 4-50: Upload Software



Aeros 9040 field computer

INTRODUCTION

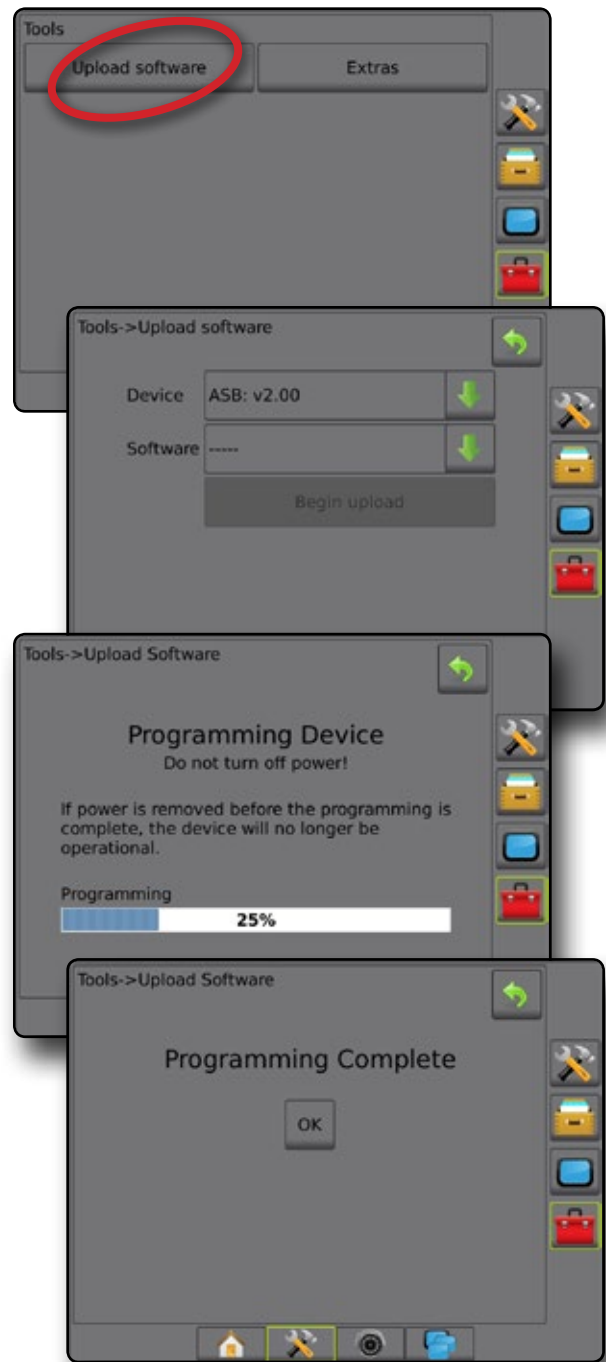
HOME

FULL SCREEN

SETUP

GNSS

IMPLEMENT

GUIDANCE

RATE CONTROL

APPENDIX

Extras

1. Press TOOLS side tab .
2. Press **Extras**.
3. Select from:
 - ▶ Calculator – used to perform mathematical calculations
 - ▶ Units converter – used to perform unit conversions for area, length, volume, pressure, mass, temperature, or angle

Figure 4-51: Calculator

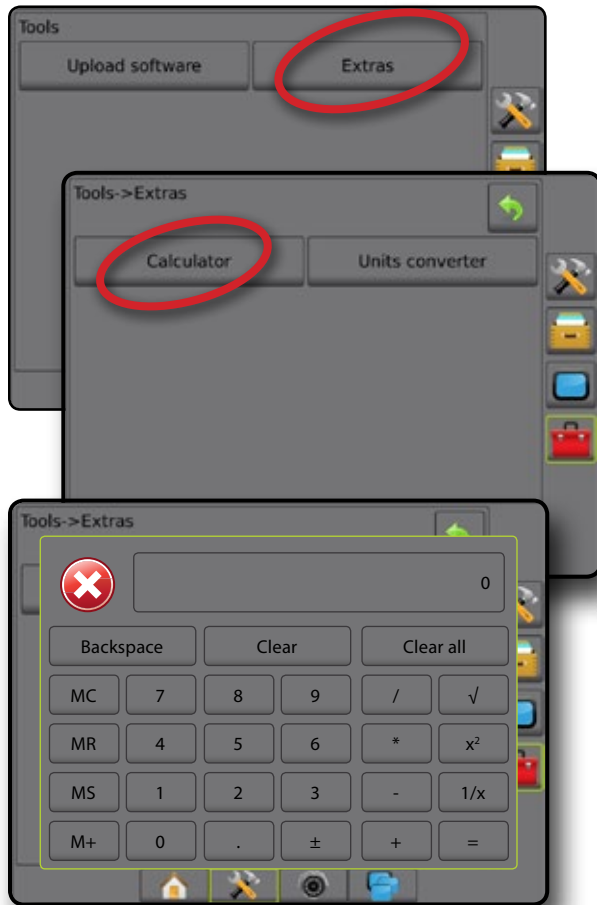
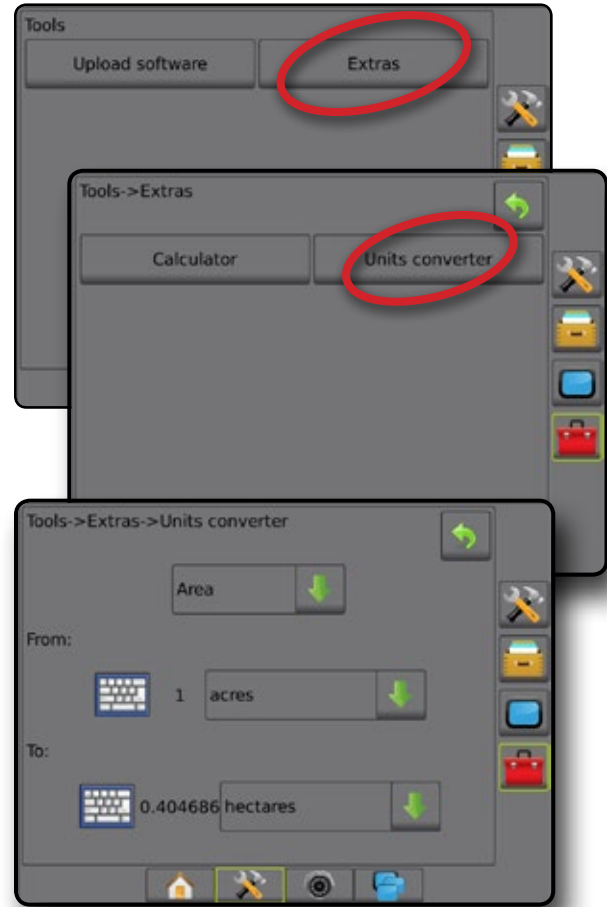

Figure 4-52: Units converter



CHAPTER 5 – GNSS RECEIVER CONFIGURATION

GNSS Receiver Configuration is used to configure GNSS type, GNSS port, and PRN, and other GNSS parameters, and to view GNSS status information.

GNSS

NOTE: These settings are required for rate control, assisted/ auto steering, and tilt sensor operation, as well as proper implement operation.



1. Press CONFIGURATION side tab .
2. Press **GNSS receiver configuration**.
3. Select from:
 - ▶ GNSS type – sets to accept GNSS source transmissions: GPS, GLONASS, or SBAS (with or without DGPS required).
 - ▶ GNSS port – sets GNSS communication port: Internal or External
 - ▶ GNSS status information – displays current baud rate, baud rate status, GNSS status information: GGA/VTG (data rates), number of satellites, HDOP, PRN, GGA quality, receiver, receiver version, UTM zone, and correction model
 - ▶ Programme – allows direct programming of the GNSS receiver through a command line interface. Only TeeJet support technicians should use this feature. Use at your own risk!
 - ▶ PRN – selects the first of two possible SBAS PRN's to provide SBAS correction data. Set to **Automatic** for automatic PRN selection.
 - ▶ Alternate PRN – when PRN is not automatic, allows possible selection of a second SBAS PRN to provide correction data
 - ▶ Show refresh GNSS position button – establishes if the refresh GNSS position button is available on the guidance screens.
4. Press RETURN arrow  or CONFIGURATION side tab  to return to the main Configuration screen.

Figure 5-1: GNSS options



GNSS type

This menu allows the user to specify the requirements of the GGA data received by the application software based on the GGA Quality Indicator data field. These selections dictate the commands sent to program the internal receiver for use.

- GPS – uncorrected signals from the GPS system
 - GLONASS – uncorrected signals from the GLONASS system
 - SBAS (e.g. EGNOS, GAGAN, MSAS, SDCM, WAAS) – differentially corrected signals from the SBAS system
 - DGPS required – differentially corrected GPS signals
1. Press NEXT PAGE arrow → to access the list of options.
 2. Select:
 - ▶ GPS – single point uncorrected position data based on GPS only with a GGA QI of "1" is accepted.
NOTE: GPS is always selected.
 - ▶ GPS+GLONASS – single point uncorrected position data based on GPS and GLONASS with a GGA QI of "1" is accepted.
 - ▶ GPS+SBAS – either single point uncorrected or SBAS corrected position data are accepted - GGA QI of "1" or "2" (3, 4 or 5 are also accepted).
 - ▶ GPS+GLONASS+SBAS – either single point uncorrected or SBAS corrected position data are accepted - GGA QI of "1" or "2" (3, 4 or 5 are also accepted).
 - ▶ GPS+GLONASS+SBAS+DGPS – only GGA data with a QI value of "2" or higher is accepted (3, 4 or 5 are also accepted).
NOTE: All console based mapping, application and guidance functions are ceased if the GGA QI value drops below "2" with this setting checked.
 3. Exit this screen to begin initializing the GNSS receiver. This takes about a minute, and the console will not respond until complete.

Figure 5-2: GNSS type

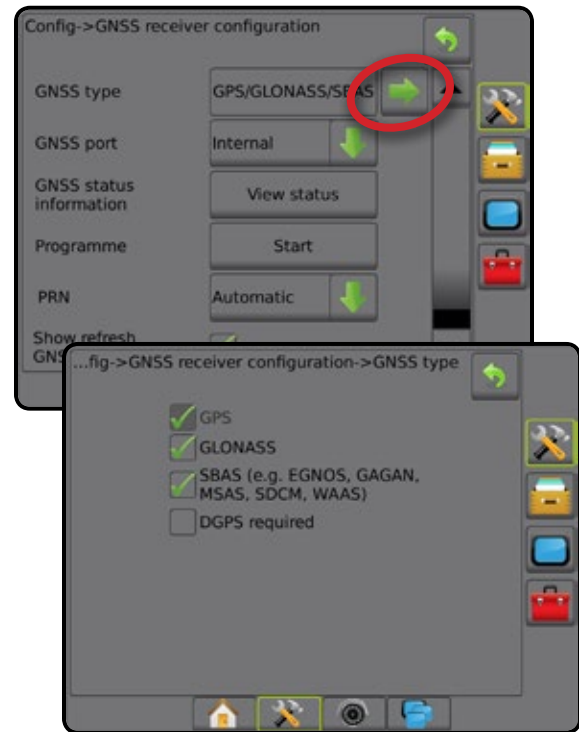

GNSS port

The COM port can be set to "Internal" to use the internal GNSS receiver and transmit out, or "External" to receive external GNSS data.

1. Press DOWN arrow ↓ to access the list of options.
2. Select:
 - ▶ Internal – uses position data from the internal GNSS receiver; these NMEA data are sent out the RS-232 serial "Port A" of the Aeros harness at 115,200 baud
 - ▶ External – uses position data from an externally attached GNSS receiver attached to the RS-232 serial "Port A" of the Aeros harness

NOTE: An external receiver is required to work with TerraStar, OmniStar HP/XP, or RTK position data.

Figure 5-3: GNSS port



External receiver minimum configuration requirements

Before the Aeros will connect and work with an external GNSS receiver, these minimum configuration requirements must be met.

Serial port settings

Baud rate:	not allowed below 38,400
Recommended	38,400, 56,000, 57,600, 76,800, or 115,200
FieldPilot Pro / UniPilot Pro	115,200
Data bits:	8
Parity:	None
Stop bits:	1

Serial Port connection requirements

Male 9-pin RS-232 serial cable

NOTE: May require Null modem adapter depending on pin-out of receiver.

NMEA Strings

GGA	10.0 Hz
Optional VTG	10.0 Hz
ZDA	1.0 Hz

GNSS status information

GNSS status information displays a snapshot of the current GNSS status information.

1. Press **View status**.
2. View data including:
 - ◀ Baud rate – the current status of the GNSS
 - ◀ Baud rate status – the rate at which information is transferred/communicated.

NOTE: a minimal baud rate maybe required for some software version to work at their peak performance.
 - ◀ GGA/VTG/TCP data rates – the number of GNSS positions per second.
 - ◀ Number of satellites – the number of GNSS satellites in view (minimum of 4 are required for DGPS)
 - ◀ HDOP – a measure of satellite geometry strength in the horizontal plane. A HDOP value of less than 2 is preferred.
 - ◀ PRN – the current DGPS satellite ID
 - ◀ GGA quality – the current quality indicator of the GNSS signal (see GGA requirements chart)
 - ◀ Receiver – the current indicator of the receiver
 - ◀ Receiver version – the software version installed on the receiver

- ◀ UTM zone – zone where currently located (see "UTM coordinates and zones" in this manual)
- ◀ Model – the correction models available to be used with the current receiver configuration

3. Press **OK** to return to the GNSS receiver configuration screen.

NOTE: If GNSS is not available, all entries will be "Invalid".

Figure 5-4: GNSS status information

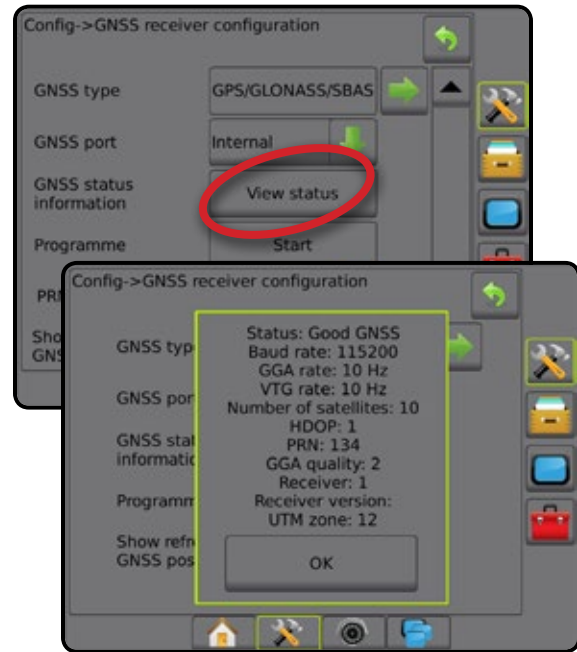

GNSS status information on Guidance screens

GNSS status displays information regarding current GNSS status, including data rates, number of satellites in view, HDOP and PRN status, receiver and version, satellite quality and ID, and UTM zone.

1. Press GNSS STATUS icon .

Figure 5-5: Guidance screen GNSS status information

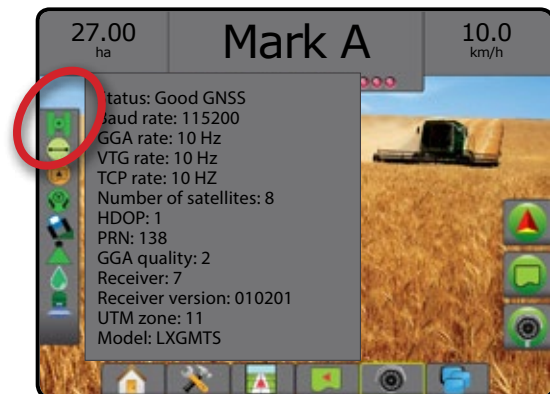

GGA requirements

GGA quality required to be able to work with various types of signal can vary. See table below for requirements.

Service	Indicator	Accuracy
GPS/GLONASS only	1	<10 m
WAAS/EGNOS	2	<1.5 m
RTK	4 or 5	4 cm
OmniSTAR HP/XP	5	10 cm
Glide/ClearPath*	9	<1 m
TerraStar C (converged)	5	10 cm

*For a 60 minute period.

Programme

Programme allows direct programming of the GNSS receiver through a command line interface. Only TeeJet support technicians should use this feature. Use at your own risk!

1. Press **Start**.
2. Adjust programming as required.

Figure 5-6: Programming receiver

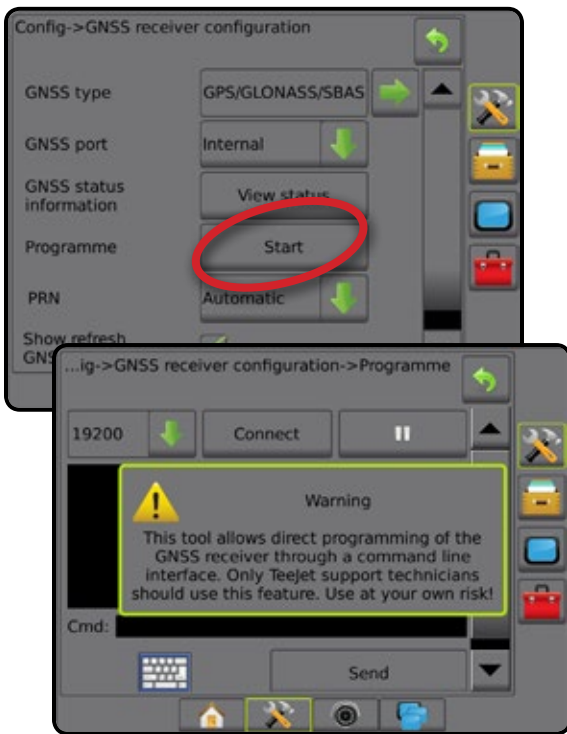

PRN

The PRN menu allows selection of up to two specific SBAS satellites to use for SBAS corrections. This allows the user to remove SBAS correction data from malfunctioning SBAS satellites.

1. Press DOWN arrow ↓ to access the list of options.
2. Select:
 - ▶ Automatic – automatic PRN selection
 - ▶ Number – contact your local dealer for the number associated with your operating location

Figure 5-7: PRN

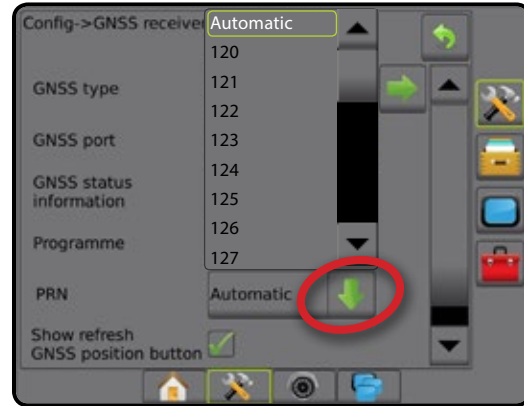

Alternate PRN

When PRN is not automatic, allows possible selection of a second SBAS PRN to provide correction data.

1. Press DOWN arrow ↓ to access the list of options.
2. Select:
 - ▶ None – no alternate PRN number
 - ▶ Number – contact your local dealer for the number associated with your operating location

Figure 5-8: Alternate PRN

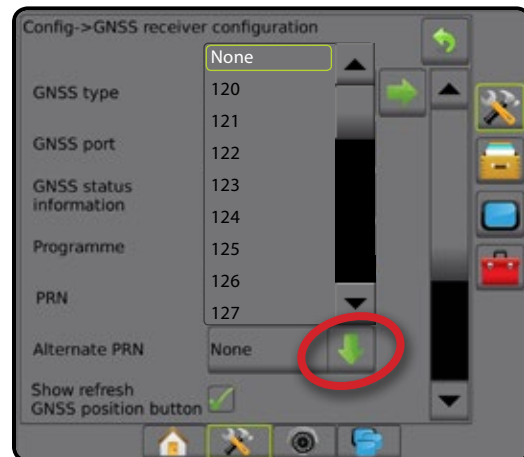

PRN not shown

PRN options are only available with SBAS GNSS type selected.

Figure 5-9: PRN not shown



Show refresh GNSS position button

Show refresh GNSS position button establishes if the refresh GNSS position button is available on the guidance screens.

The refresh GNSS position button will reset the ClearPath filter in the OEMStar receiver in cases where the user has had the receiver running in close proximity to heavy tree cover and/or buildings.

NOTE: Activating the refresh while in a job will cause a momentary interruption in the relay of GNSS data. This will most likely result in sections already on in automatic BoomPilot mode to go off for a short period of time.

The refresh should not be done during active application.

Figure 5-10: Refresh GNSS position button

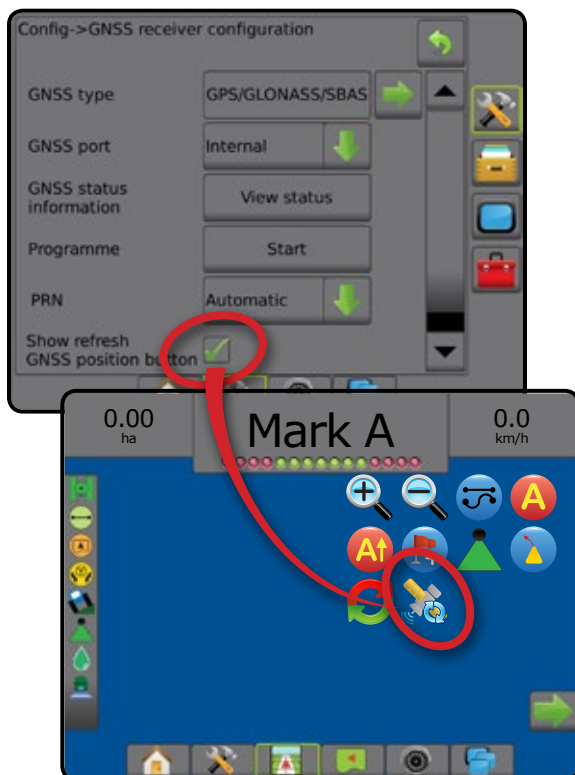

GNSS glossary

Commercial satellite provider:

Another common source for DGPS signals. Error correction information obtained from their base stations is sent to a communications satellite (separate from the GPS satellites) and broadcast to the user. These satellite-based corrections tend to have more widespread coverage than tower-based broadcasts (FM links), and system accuracy is not greatly affected by the user's distance from the base station receivers. Most of these service providers require a subscription fee for use. A commonly known provider is OmniSTAR.

CORS (Continuously operating reference station)/ Network RTK:

A series of base stations spread across a given geographic region (such as an entire state/county) that are networked via a centralized computer and which broadcast RTK correction data over the Internet. CORS networks may be publicly or privately owned/operated and may offer a free signal or require an annual subscription fee. By accessing a CORS network via a cellular connection, the end-user eliminates the need to own a base station.

Differential corrections

Differential corrections is a solution specific to the "double-differencing" algorithm used to determine the correction values applied by RTK to each GNSS satellites range data. "Corrections" is the generic term applied to all forms of potential corrections from SBAS (WAAS/EGNOS) through to OmniStar, TerraStar PPP and RTK.

Differential GPS (DGPS):

Use of the specific RTK solution to apply differential corrections to the GPS satellite constellation data.

EGNOS (European geostationary navigation overlay service):

A satellite based augmentation system (SBAS) developed jointly by the European space agency (ESA), European community and EUROCONTROL. The system is free to use and provides differential correction coverage primarily across the European continent. EGNOS delivers pass-to-pass accuracies of 15-25 cm and year-to-year accuracies of +/-1 m.

GLONASS (Global navigation satellite system):

A global satellite navigation system developed and operated by the Russian government. It is composed of approximately 24 satellites which continuously orbit the earth. While early GNSS receivers typically utilized only GPS signals, many of today's GNSS receivers can utilize signals from both GPS and GLONASS, effectively increasing the total number of satellites available for use.

GNSS Precise Point Positioning (PPP)

PPP is a subscription based globally provided satellite correction service broadcast to properly equipped GNSS receivers. PPP utilizes a global array of reference stations to correct for satellite clock and orbit errors which are then broadcast to local receivers. PPP does require a convergence time.

GNSS (Global navigation satellite system):

A general term that refers to a multiple satellite navigation system used by a receiver to compute its position. Examples of these systems include: GPS developed by the United States and GLONASS by Russia. Additional systems in development include Galileo by the European Union and Compass by China. New generation GNSS receivers are being designed to utilize multiple GNSS signals (such as GPS and GLONASS). Depending on constellation and desired accuracy levels, system performance may be improved by having access to a greater number of satellites.

GPS (Global positioning system):

The name of the satellite-navigation network maintained by the U.S. Department of Defense. It is composed of approximately 30 satellites which continuously orbit the earth. The term is also used to refer to any device that depends on navigation satellites for functionality.

NTRIP (Networked transportation of RTCM via internet protocol):

An internet-based application that makes the RTCM correction data from the CORS stations available to anyone with an internet connection and the appropriate log-on credentials to the NTRIP server. Typically uses a cellular link to get to the internet and the NTRIP server.

Positional drift

The constant change in the GNSS position calculation primarily caused by atmospheric and ionospheric changes, poor satellite geometry (possibly caused by obstructions such as buildings and trees, satellite clock errors and satellite constellation changes. For sub-decimeter accuracy dual frequency receivers using either PPP or RTK solutions are recommended.

RTK (Real time kinematic):

Currently the most accurate GPS correction system available that uses a land-based reference station located in relatively close proximity to the GPS receiver. RTK can provide one-inch, also known as centimeter, pass-to-pass accuracy and also provides year-to-year position stability. RTK users can have their own base stations, subscribe to RTK Networks or use CORS.

SBAS (Satellite based augmentation system):

A general term that refers to any satellite-based differential correction system. Examples of SBAS include: WAAS in the United States, EGNOS in Europe and MSAS in Japan. Additional SBAS covering other regions of the world will likely be coming online in the future.

WAAS (Wide-area augmentation system):

A satellite correction service developed by the Federal Aviation Administration (FAA). It is free to use and provides coverage across the U.S. along with parts of Canada and Mexico. WAAS delivers pass-to-pass accuracies of 15-25 cm; however, year-to-year accuracy will be in the range of +/-1 m.

CHAPTER 6 – IMPLEMENT SETUP

Implement setup is used to establish the various settings associated with straight mode, spreader mode, and staggered mode.

Settings will vary depending on if there is section control available (SmartCable, Section driver module (SDM), or Switch function module (SFM) or ISOBUS) or if there is an ISOBUS rate controller on the system.

Multiple section output modules

Multiple section output modules may be installed on the CAN bus to allow more sections than a single module allows. If a section control module is on the system, the settings for Multiple section output modules should be set up first.





1. Press CONFIGURATION side tab .
2. Press **Implement**.
3. Press Multiple section output modules NEXT PAGE arrow .
4. Press **Refresh**.
5. Press DOWN arrow  and assign the correct Module ID to the sections.
6. Press **Activate modules**.
7. Press RETURN arrow  to return to the Implement screen or CONFIGURATION side tab  to return to the main Configuration screen.

Figure 6-1: Setup options for multiple section output modules



IMPLEMENT TYPE

Implement type selects the type of application pattern that most closely represents your system.

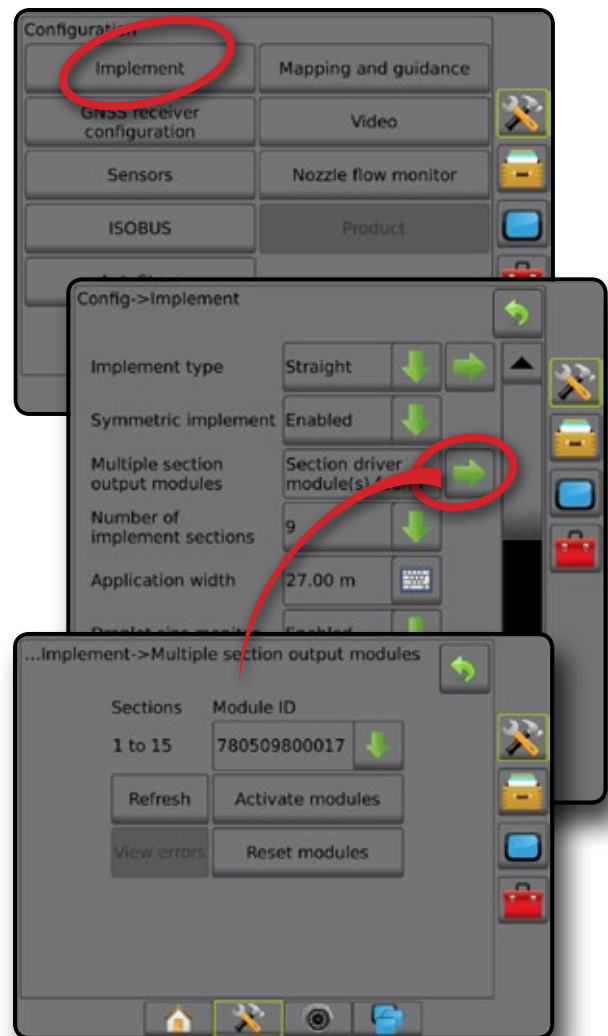
- In Straight mode – the boom sections have no length and are on a line a fixed distance from the antenna
- In Spreader mode – a virtual line is created in line with the delivery disks from which the application section or sections can vary in length and can be at different distances from the line (availability depends on the specific equipment in the system)
- In Staggered mode – a virtual line is created in line with section 1 from which the application section or sections have no length and can be at different distances from the line (availability depends on the specific equipment in the system)

Figure 6-2: Implement type – Straight

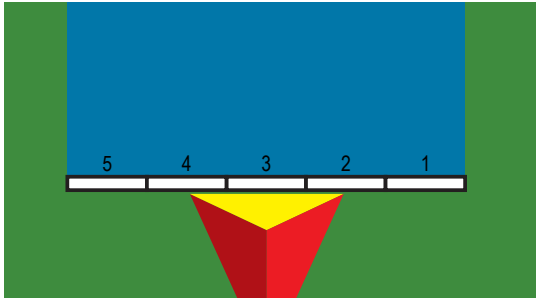

Figure 6-3: Implement type – Spreader

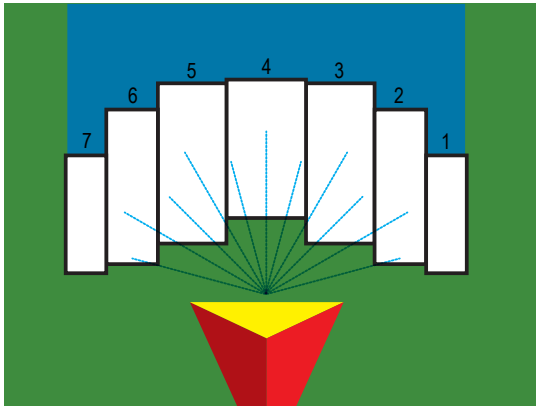
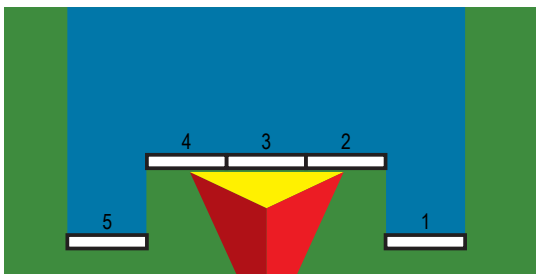

Figure 6-4: Implement type – Staggered



Section numbers

Sections are numbered from left to right while facing in the machine's forward direction.

Straight

The boom sections have no length and are on a line a fixed distance from the antenna.

Single section

No section control or ISOBUS Sprayer is available on the system.

1. Select **Straight** implement type on Implement screen.
2. Press Implement type NEXT PAGE arrow
3. Select from:
 - ▶ Implement in-line offset direction ① – establishes if the implement is located in front of (forward) or behind (backward) the GNSS antenna while facing in the machine's forward direction
 - ▶ Implement in-line offset distance ① – measured in parallel to the centreline of the machine, defines the in-line distance from the GNSS antenna to the implement
 - ▶ Implement lateral offset direction ② – defines the lateral direction, either left or right, from the centreline of the machine to the centre of the implement while facing in the machine's forward direction
 - ▶ Implement lateral offset distance ② – defines the lateral distance from the centreline of the machine to the centre of the implement
4. Press RETURN arrow to return to the Implement screen or CONFIGURATION side tab to return to the main Configuration screen.

Figure 6-5: Single section

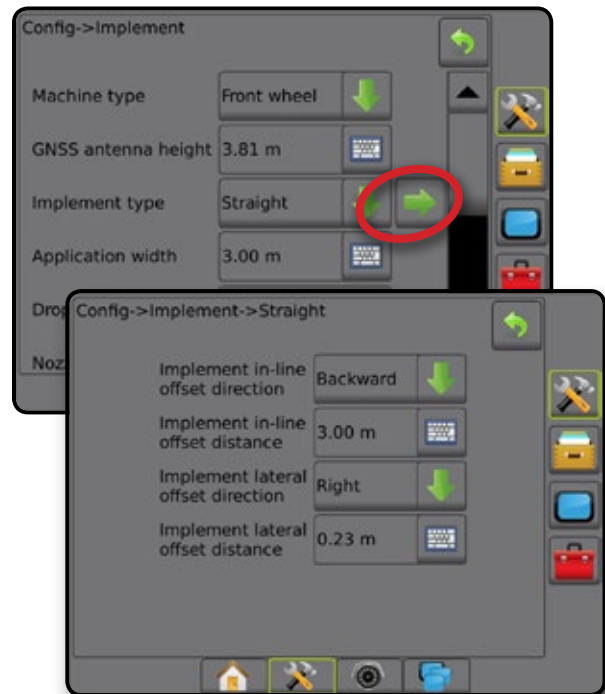
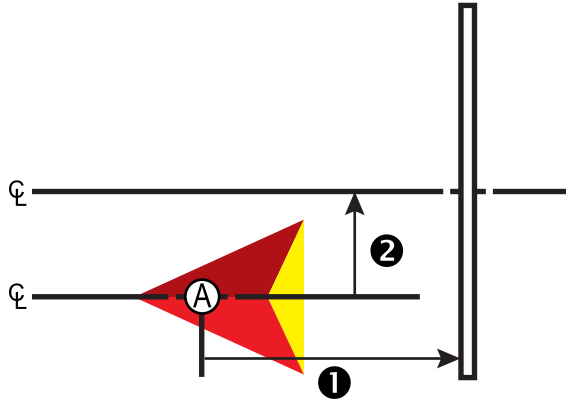

Figure 6-6: Implement offset directions and distances



- Ⓐ – Centre of the GNSS antenna
- ❶ – Implement in-line offset direction/distance
- ❷ – Implement lateral offset direction/distance

Multiple sections with SDM or SFM

Section control is available (SmartCable, Section driver module (SDM), or Switch function module (SFM)).

1. Select **Straight** implement type on Implement screen.
2. Press Implement type NEXT PAGE arrow →.
3. Select from:
 - ▶ Implement in-line offset direction ❶ – establishes if the implement is located in front of (forward) or behind (backward) the GNSS antenna while facing in the machine's forward direction
 - ▶ Implement in-line offset distance ❶ – measured in parallel to the centreline of the machine, defines the in-line distance from the GNSS antenna to the implement
 - ▶ Implement lateral offset direction ❷ – defines the lateral direction, either left or right, from the centreline of the machine to the centre of the implement while facing in the machine's forward direction
 - ▶ Implement lateral offset distance ❷ – defines the lateral distance from the centreline of the machine to the centre of the implement
 - ▶ Overlap – used to define the amount of overlap allowed when using automatic boom section control
 - ▶ Delay on time – used to set the time when the section will switch on when entering an area that has not been applied
NOTE: If the application turns on too soon when entering an unapplied area, decrease the Delay on time. If the application turns on too late, increase the Delay on time.
 - ▶ Delay off time – used to set the time when the section will switch off when entering an area that has been applied
NOTE: If the application turns off too soon when entering an unapplied area, decrease the Delay off time. If the application turns off too late, increase the Delay off time.

4. Press RETURN arrow ↶ to return to the Implement screen or CONFIGURATION side tab ⚙️ to return to the main Configuration screen.

Figure 6-7: Multiple sections

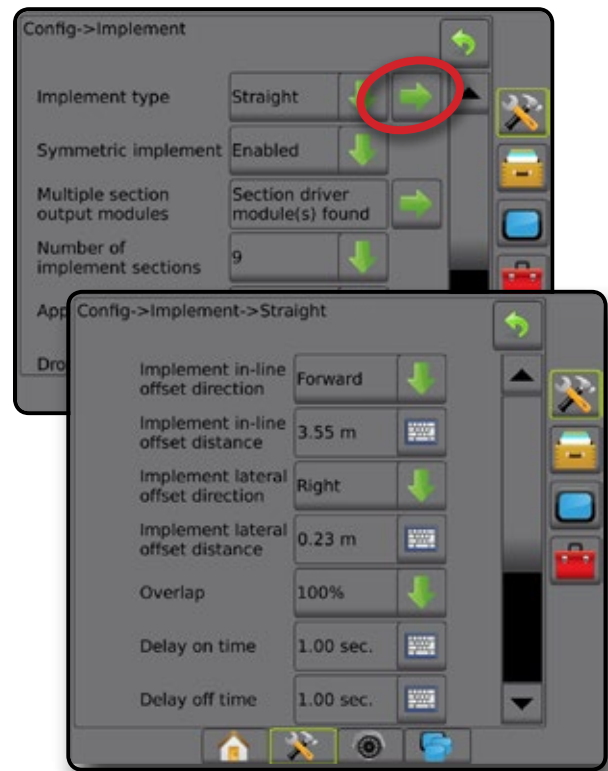
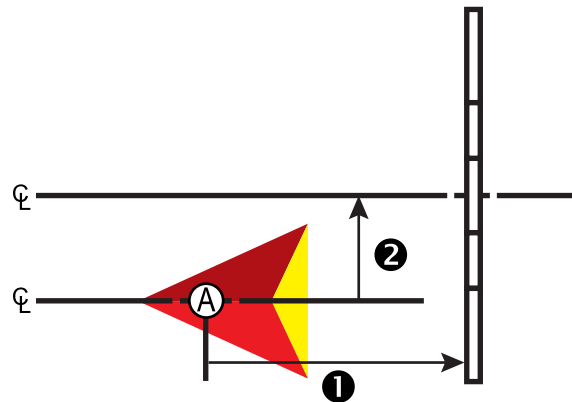
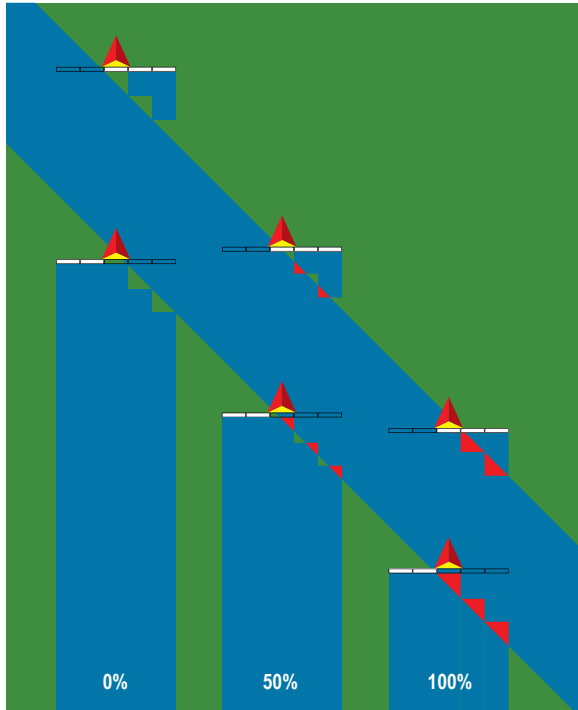

Figure 6-8: Implement offset directions and distances



- Ⓐ – Centre of the GNSS antenna
- ❶ – Implement in-line offset direction/distance
- ❷ – Implement lateral offset direction/distance

Figure 6-9: Overlap



Multiple sections with ISOBUS sprayer setup

Section control is available (ISOBUS). See "ISOBUS Sprayer Offsets" in this chapter for more details.

1. Select **Straight** implement type on Implement screen.
2. Press Implement type NEXT PAGE arrow →.
3. Select from:
 - ▶ Connection point in-line offset direction ③ – establishes if reference point ② is located in front of (forward) or behind (backward) the GNSS antenna while facing in the machine's forward direction
 - ▶ Connection point in-line offset distance ③ – measured in parallel to the centreline of the machine, defines the in-line distance from the GNSS antenna to reference point ②
 - ▶ Connection point lateral offset direction ④ – defines the lateral direction, either left or right, from the centreline of the machine to the centre of reference point ② while facing in the machine's forward direction
 - ▶ Connection point lateral offset distance ④ – defines the lateral distance from the centreline of the machine to the centre of reference point ②
 - ▶ Implement in-line offset direction ① – displays if the implement is located in front of (forward) or behind (backward) the GNSS antenna while facing in the machine's forward direction
 - ▶ Implement in-line offset distance ① – measured in parallel to the centreline of the machine, displays the in-line distance from the GNSS antenna to the implement

- ▶ Implement lateral offset direction ② – displays the lateral direction, either left or right, from the centreline of the machine to the centre of the implement while facing in the machine's forward direction
 - ▶ Implement lateral offset distance ② – displays the lateral distance from the centreline of the machine to the centre of the implement
 - ▶ Overlap – used to define the amount of overlap allowed when using automatic boom section control
 - ▶ Delay on time – used to set the time when the section will switch on when entering an area that has not been applied
NOTE: If the application turns on too soon when entering an unapplied area, decrease the Delay on time. If the application turns on too late, increase the Delay on time.
 - ▶ Delay off time – used to set the time when the section will switch off when entering an area that has been applied
NOTE: If the application turns off too soon when entering an unapplied area, decrease the Delay off time. If the application turns off too late, increase the Delay off time.
4. Press RETURN arrow ↵ to return to the Implement screen or CONFIGURATION side tab ⚙ to return to the main Configuration screen.

Figure 6-10: Implement offset directions and distances

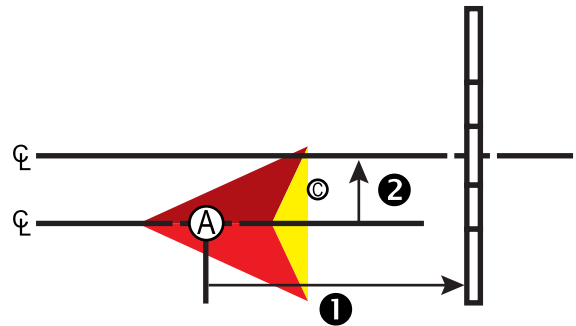
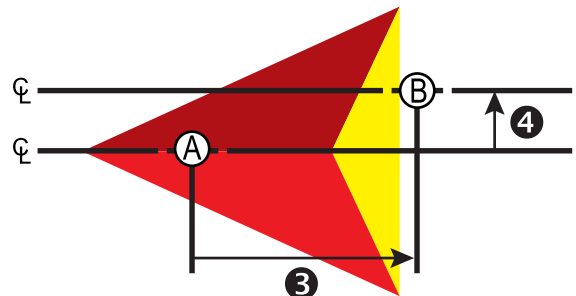

Figure 6-11: Connection point offset directions and distances



- Ⓐ – Centre of the GNSS antenna
- Ⓑ – Reference point
- ① – Implement in-line offset direction/distance
- ② – Implement lateral offset direction/distance
- ③ – Connection point in-line offset direction/distance
- ④ – Connection point lateral offset direction/distance

Figure 6-12: Multiple sections with ISOBUS Sprayer

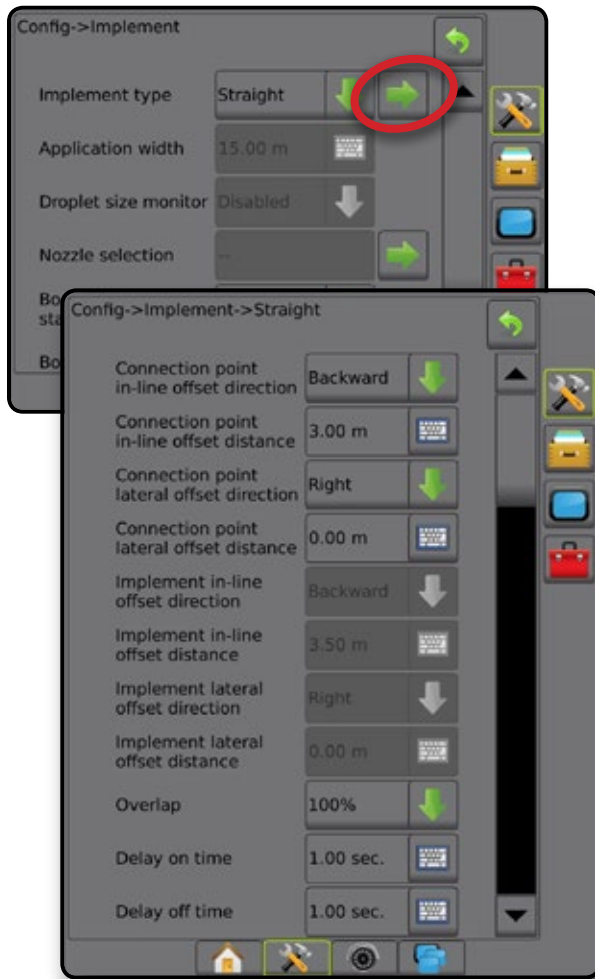
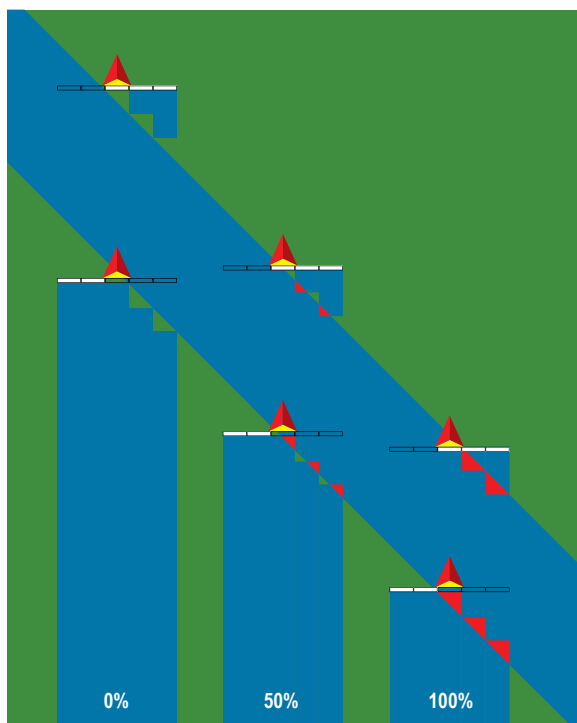

Figure 6-13: Overlap



Spreader – TeeJet

A virtual line is created in line with the delivery disks from which the application section or sections can vary in length and can be at different distances from the line (availability depends on the specific equipment in the system).

Single section

No section control is available on the system.



1. Select **Spreader** implement type on Implement screen.
2. Press Implement type NEXT PAGE arrow .
3. Select from:
 - ▶ Setup type – used to select **TeeJet** spreader type
 - ▶ Antenna to disks in-line offset distance **1** – measured in parallel to the centreline of the machine, defines the in-line distance from the GNSS antenna to the disks, or dispersal mechanism
 - ▶ Implement lateral offset direction **2** – defines the lateral direction, either left or right, from the centreline of the machine to the centre of the implement while facing in the machine's forward direction
 - ▶ Implement lateral offset distance **2** – defines the lateral distance from the centreline of the machine to the centre of the implement
 - ▶ Spread offset distance **3** – used to set the distance between the disks or dispersal mechanism and where product initially hits the ground for the section
 - ▶ Spread length **4** – used to set the length of application for the section
4. Press RETURN arrow  to return to the Implement screen or CONFIGURATION side tab  to return to the main Configuration screen.

Figure 6-14: Single section

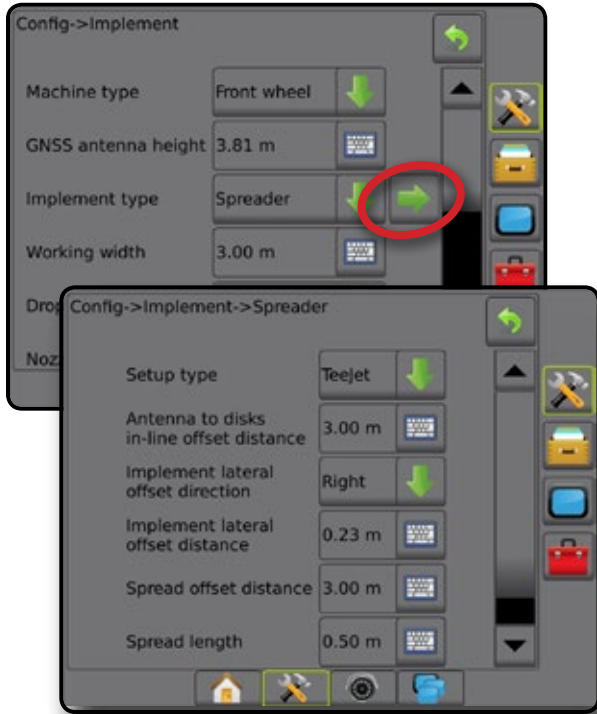

Figure 6-15: Distances and length

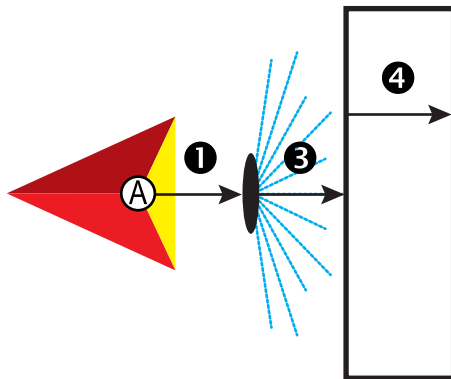
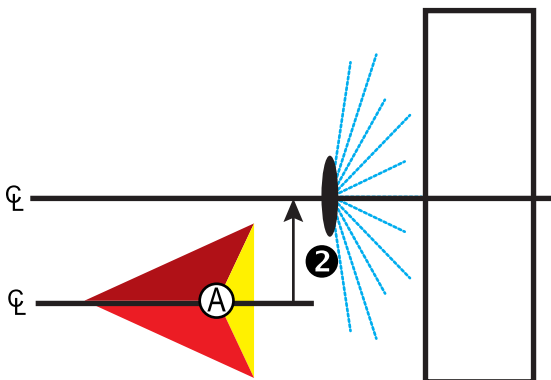

Figure 6-16: Lateral offset direction and distance



- Ⓐ – Centre of the GNSS antenna
- ① – Antenna to disks in-line offset distance
- ② – Implement lateral offset direction/distance
- ③ – Spread offset distance
- ④ – Spread length

Multiple sections

Section control is available (SmartCable, Section driver module (SDM), or Switch function module (SFM) or ISOBUS).

1. Select **Spreader** implement type on Implement screen.
2. Press Implement type NEXT PAGE arrow →.
3. Select from:
 - ▶ Setup type – used to select **TeeJet** spreader type
 - ▶ Antenna to disks in-line offset distance ① – measured in parallel to the centreline of the machine, defines the in-line distance from the GNSS antenna to the disks, or dispersal mechanism
 - ▶ Implement lateral offset direction ② – defines the lateral direction, either left or right, from the centreline of the machine to the centre of the implement while facing in the machine's forward direction
 - ▶ Implement lateral offset distance ② – defines the lateral distance from the centreline of the machine to the centre of the implement
 - ▶ Overlap – used to define the amount of overlap allowed when using automatic boom section control
 - ▶ Delay on time – used to set the time when the section will switch on when entering an area that has not been applied
NOTE: If the application turns on too soon when entering an unapplied area, decrease the Delay on time. If the application turns on too late, increase the Delay on time.
 - ▶ Delay off time – used to set the time when the section will switch off when entering an area that has been applied
NOTE: If the application turns off too soon when entering an unapplied area, decrease the Delay off time. If the application turns off too late, increase the Delay off time.
 - ▶ Spread offset distance ③ – used to set the distance between the disks or dispersal mechanism and where product initially hits the ground on section 1.
 - ▶ Section offsets ④ – used to set the offset distance from section 1 (the Spread offset line) to the leading edge of each section. section 1 is always 0. All other sections can be different distances.
 - ▶ Section lengths ⑤ – used to set the length of application in each section. Each section can be a different length.
NOTE: Sections are numbered from left to right while facing in the machine's forward direction.
4. Press RETURN arrow ↵ to return to the Implement screen or CONFIGURATION side tab ⚙ to return to the main Configuration screen.

Figure 6-17: Multiple sections

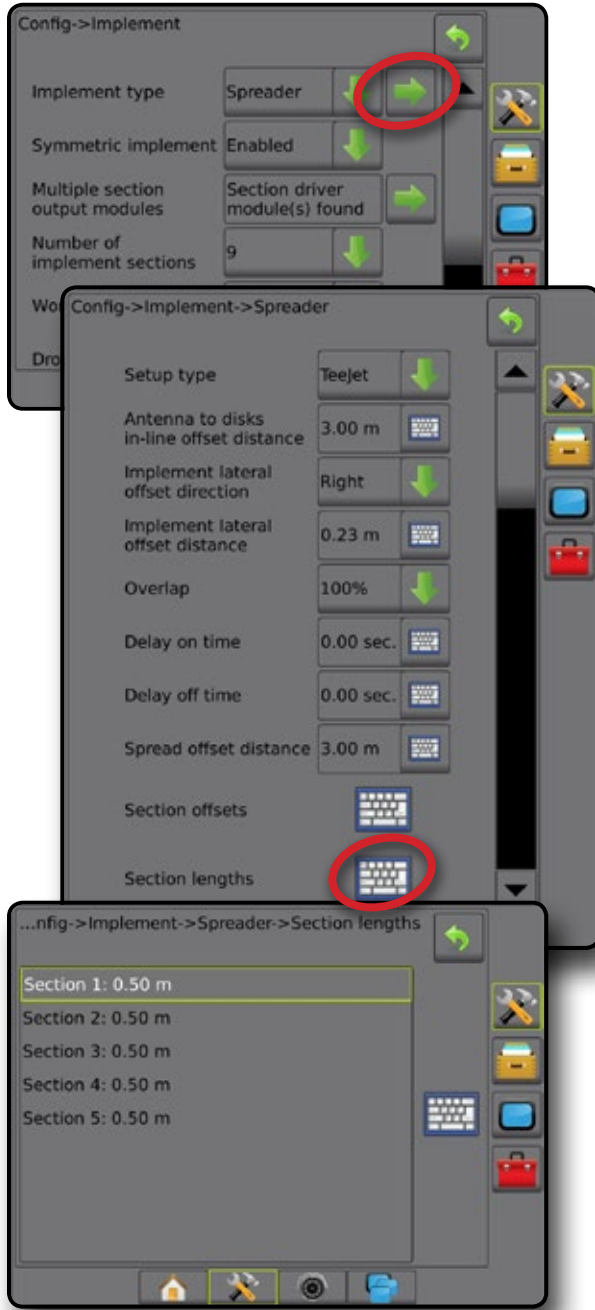

Figure 6-18: Distances and length

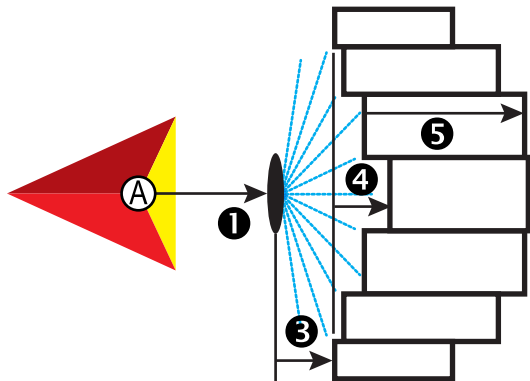
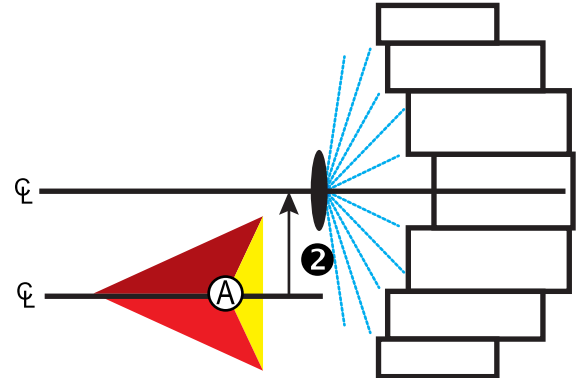
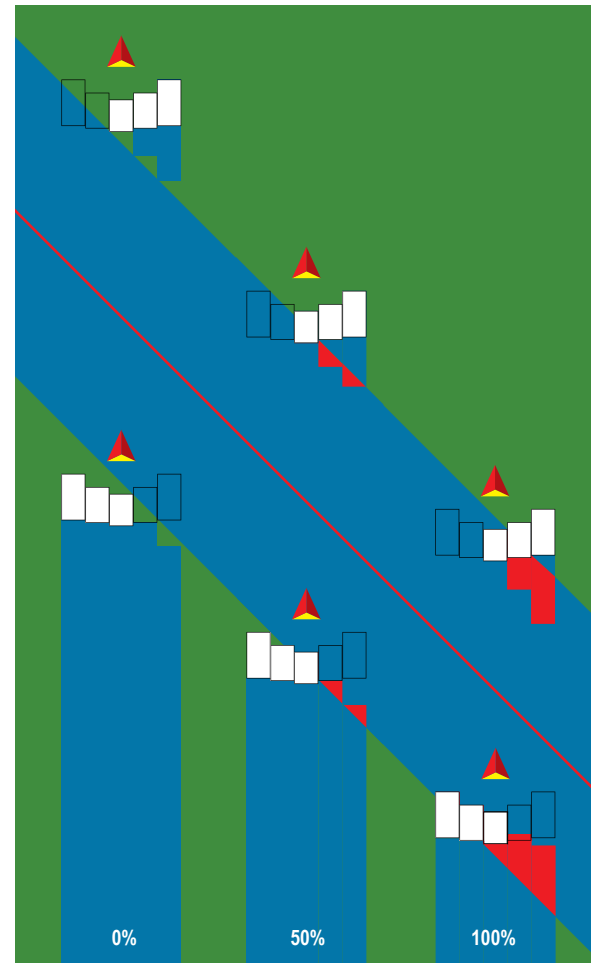

Figure 6-19: Lateral offset direction and distance



- Ⓐ - Centre of the GNSS antenna
- ❶ - Antenna to disks in-line offset distance
- ❷ - Implement lateral offset direction/distance
- ❸ - Spread offset distance
- ❹ - Section offsets
- ❺ - Section lengths

Figure 6-20: Overlap



Spreader – OEM

A virtual line is created in line with the delivery disks from which the application section or sections can vary in length and can be at different distances from the line.

Single section

No section control is available on the system.





1. Select **Spreader** implement type on Implement screen.
2. Press Implement type NEXT PAGE arrow .
3. Select from:
 - ▶ Setup type – used to select **OEM** spreader type
 - ▶ Antenna to disks in-line offset distance – measured in parallel to the centreline of the machine, defines the in-line distance from the GNSS antenna to the disks, or dispersal mechanism
 - ▶ Implement lateral offset direction – defines the lateral direction, either left or right, from the centreline of the machine to the centre of the implement while facing in the machine's forward direction
 - ▶ Implement lateral offset distance – defines the lateral distance from the centreline of the machine to the centre of the implement
 - ▶ Start distance – used to set the start distance when exiting an applied area (consult spreader manufacturer for value)
 - ▶ Stop distance – used to set the stop distance when entering an applied area (consult spreader manufacturer for value)
NOTE: Consult spreader manufacturer for start and stop distances.
4. Press RETURN arrow  to return to the Implement screen or CONFIGURATION side tab  to return to the main Configuration screen.

Figure 6-21: Single section

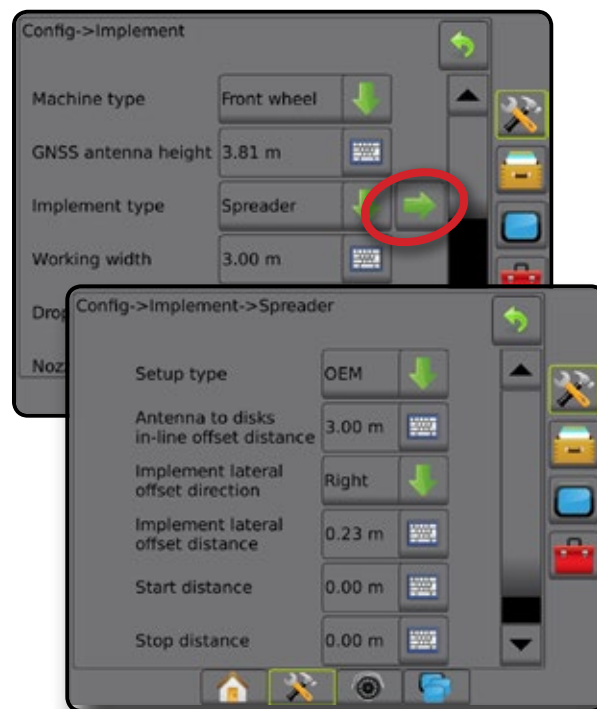

Multiple sections

Section control is available (SmartCable, Section driver module (SDM), or Switch function module (SFM) or ISOBUS).

1. Select **Spreader** implement type on Implement screen.
2. Press Implement type NEXT PAGE arrow .
3. Select from:
 - ▶ Setup type – used to select **OEM** spreader type
 - ▶ Antenna to disks in-line offset distance – measured in parallel to the centreline of the machine, defines the in-line distance from the GNSS antenna to the disks, or dispersal mechanism
 - ▶ Implement lateral offset direction – defines the lateral direction, either left or right, from the centreline of the machine to the centre of the implement while facing in the machine's forward direction
 - ▶ Implement lateral offset distance – defines the lateral distance from the centreline of the machine to the centre of the implement
 - ▶ Start distance – used to set the start distance when exiting an applied area (consult spreader manufacturer for value)
 - ▶ Stop distance – used to set the stop distance when entering an applied area (consult spreader manufacturer for value)
NOTE: Consult spreader manufacturer for start and stop distances.
 - ▶ Section start offsets – used to set the offset distance from section 1 to the leading edge of each section. Section 1 is always 0. All other sections can be different distances.

- ▶ Section stop offsets – used to set the offset distance from section 1 to the trailing edge of each section. Each section can be a different distance.

NOTE: Consult spreader manufacturer for section start and stop offset values. Sections are numbered from left to right while facing in the machine's forward direction.



4. Press RETURN arrow  to return to the Implement screen or CONFIGURATION side tab  to return to the main Configuration screen.

Figure 6-22: Multiple sections



Staggered

A virtual line is created in line with section 1 from which the application section or sections have no length and can be at different distances from the line.

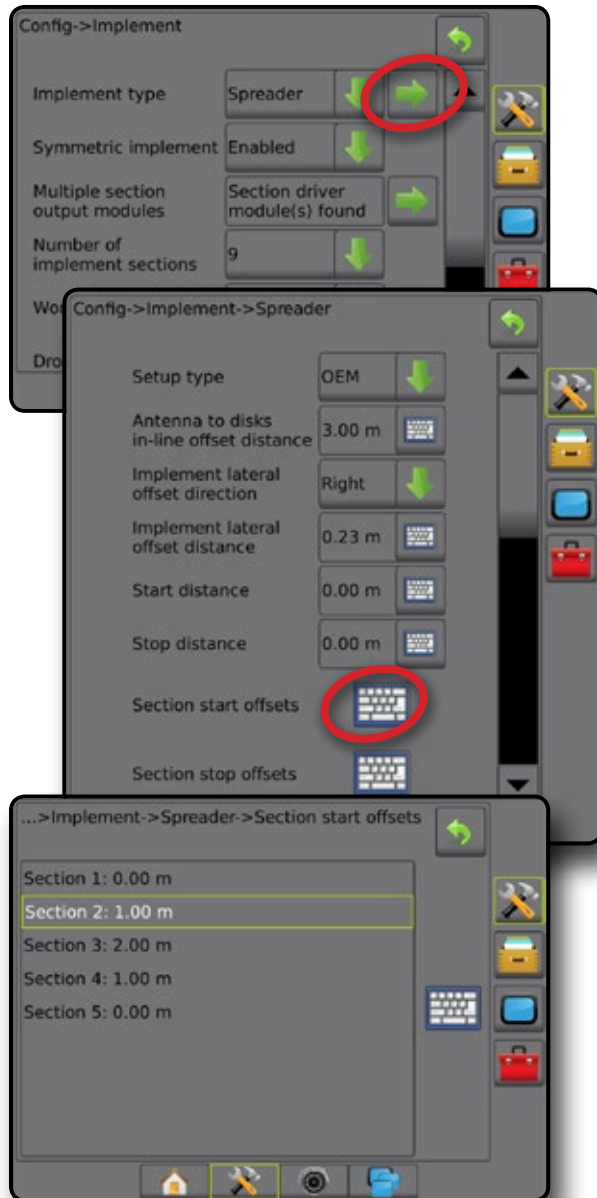
Multiple sections

Section control is available (SmartCable, Section driver module (SDM), or Switch function module (SFM) or ISOBUS).

1. Select **Staggered** implement type on Implement screen.
2. Press Implement type NEXT PAGE arrow .
3. Select from:

- ▶ Section 1 in-line offset direction ① – establishes if Section 1 (the zero-point of the Section Offsets) is located in front of (forward) or behind (backward) the GNSS antenna while facing in the machine's forward direction
- ▶ Section 1 in-line offset distance ① – measured in parallel to the centreline of the machine, defines the in-line distance from the GNSS antenna to Section 1 (the zero-point of the Section Offsets). Sections are numbered from left to right while facing in the machine's forward direction
- ▶ Implement lateral offset direction ② – defines the lateral direction, either left or right, from the centreline of the machine to the centre of the implement while facing in the machine's forward direction.
- ▶ Implement lateral offset distance ② – defines the lateral distance from the centreline of the machine to the centre of the implement
- ▶ Overlap – used to define the amount of overlap allowed when using automatic boom section control
- ▶ Delay on time – used to set the time when the section will switch on when entering an area that has not been applied
NOTE: If the application turns on too soon when entering an unapplied area, decrease the Delay on time. If the application turns on too late, increase the Delay on time.
- ▶ Delay off time – used to set the time when the section will switch off when entering an area that has been applied
NOTE: If the application turns off too soon when entering an unapplied area, decrease the Delay off time. If the application turns off too late, increase the Delay off time.
- ▶ Section offsets ③ – used to set the offset distance from section 1 (the In-line section 1 offset distance line) to each section. A positive offset value will move the section behind section 1. A negative offset value will move the section in front of section 1. Section 1 is always 0. All other sections can be different distances.



4. Press RETURN arrow  to return to the Implement screen or CONFIGURATION side tab  to return to the main Configuration screen.

Figure 6-23: Multiple sections

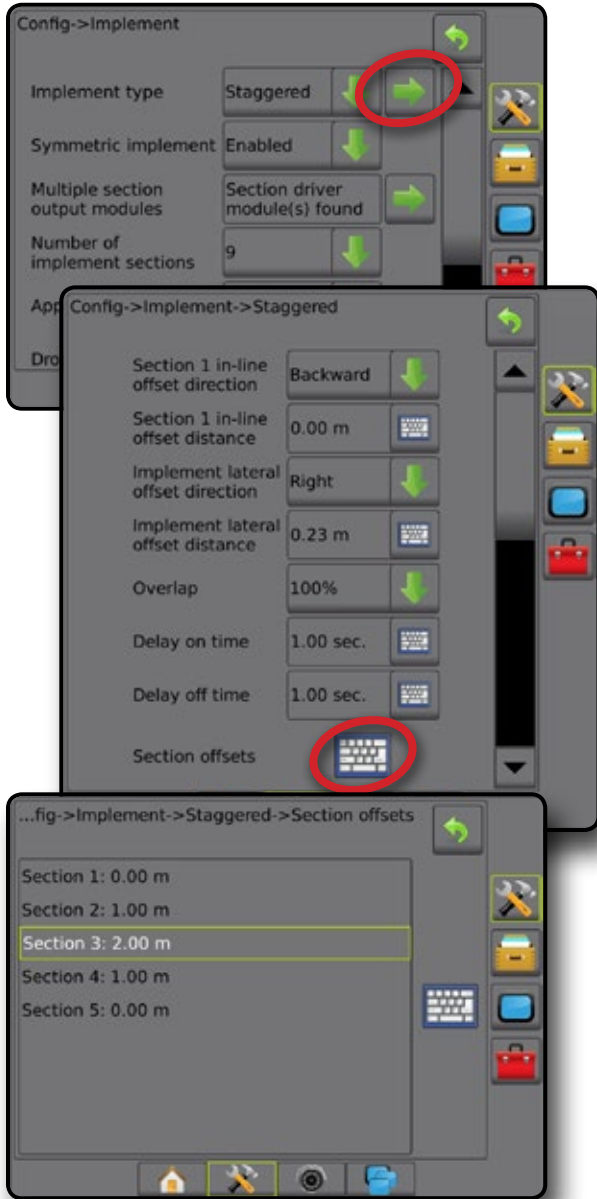
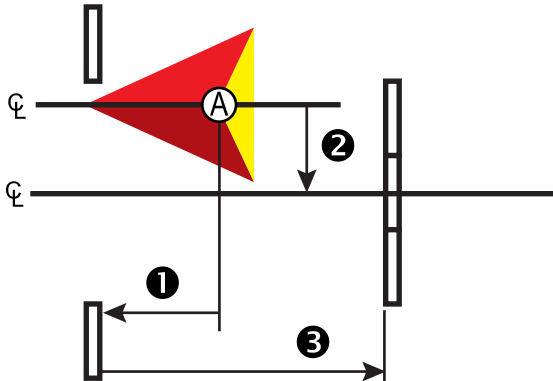
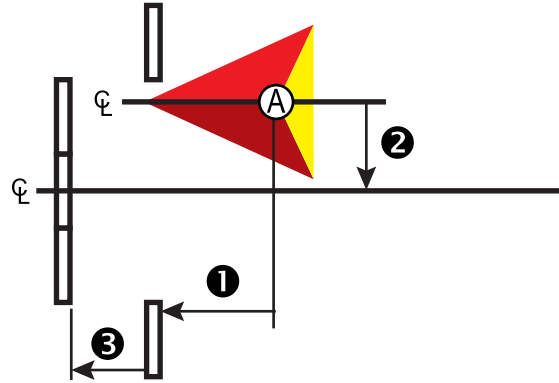

Figure 6-24: Offset directions and distances – behind section 1



- Ⓐ – Centre of the GNSS antenna
- ❶ – Section 1 in-line offset direction/distance
- ❷ – Implement lateral offset direction/distance
- ❸ – Section offsets

Figure 6-25: Offset directions and distances – in front of section 1



- Ⓐ – Centre of the GNSS antenna
- ❶ – Section 1 in-line offset direction/distance
- ❷ – Implement lateral offset direction/distance
- ❸ – Section offsets

Figure 6-26: Overlap

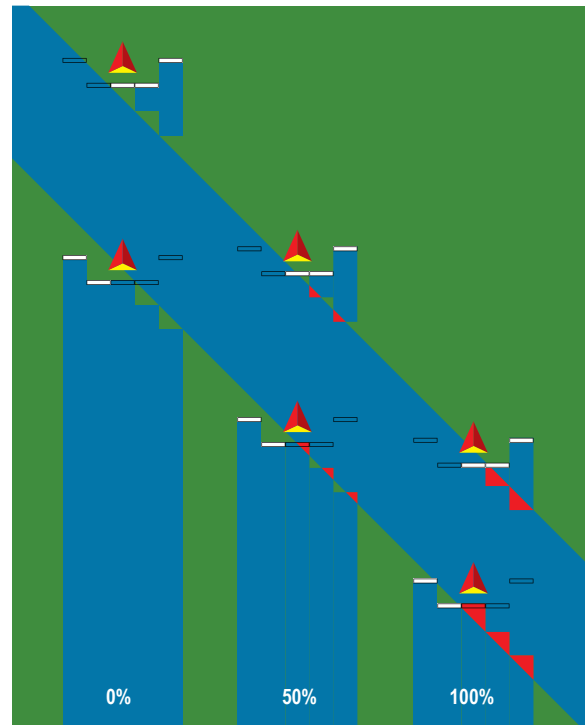

APPLICATION OR WORKING WIDTH

Application width [Straight implement type or Staggered implement type] or Working width [Spreader implement type] is used to enter the width of the single section or width of each section to calculate the total width of the implement.

Single section

No section control is available on the system.

Application width or Working width is used to enter the total width of the single section of the implement. Range is 1.0 to 75.0 metres.





1. Press CONFIGURATION side tab .
2. Press **Implement**.
3. Press the Application width [Straight implement type] or Working width [Spreader implement type] KEYPAD icon .
4. Use the numeric keypad to enter a value.
5. Press RETURN arrow  or CONFIGURATION side tab  to return to the main Configuration screen.





Figure 6-27: Single section – Application or Working width

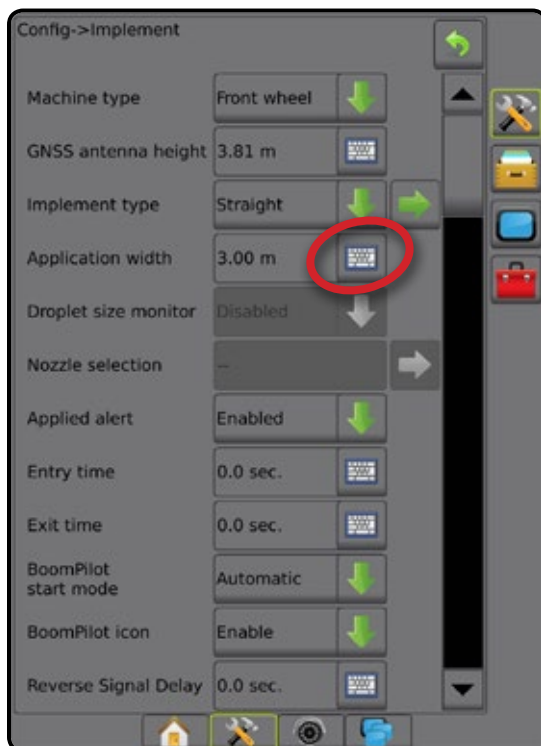

Multiple sections

Section control is available when any of the following are on the system: SmartCable, Section driver module (SDM), Switch function module (SFM) or compatible ISOBUS Implement ECU.

Application width or Working width is used to enter the width of each section to calculate the total width of all sections of the implement. Each section can be a different width. Sections are numbered from left to right while facing in the machine's forward direction. Range for each section is 0.0 to 75.0 metres. Total for all sections must be greater than 1.0 metre.

1. Press CONFIGURATION side tab .
2. Press **Implement**.
3. Press the Application width [Straight implement type or Staggered implement type] or Working width [Spreader implement type] KEYPAD icon .
4. Highlight the section to be entered or edited.
5. Press the KEYPAD icon .
6. Use the numeric keypad to enter the width of the selected section.
7. Press RETURN arrow  or CONFIGURATION side tab  to return to the Implement screen or main Configuration screen.

NOTE: If Symmetric implement layout is enabled, only the first of each pair of aligned sections will be available to be highlighted.

Figure 6-28: Multiple sections – Application or Working width

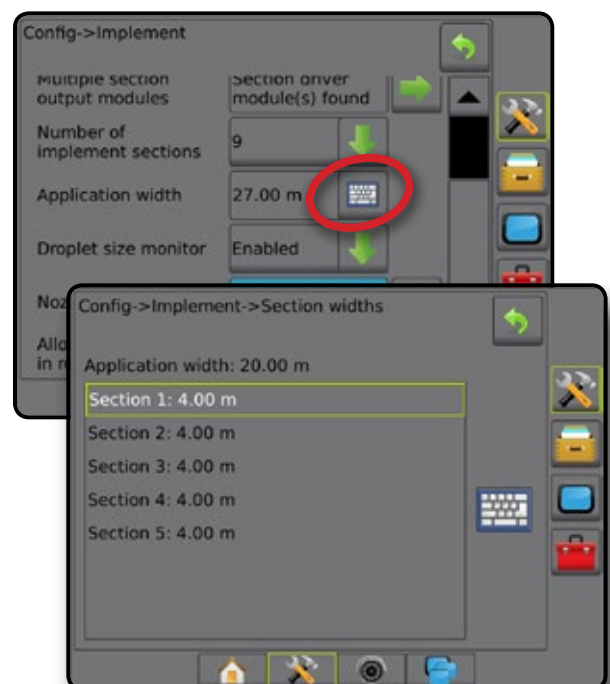

ISOBUS SPRAYER OFFSETS

Connection point and implement offsets are used to enter the directions and distances from the centreline of the machine to the connection point and implement when Aeros has an ISOBUS Sprayer on the system.

Different machines have different options. The following machines are detailed in this manual. Contact your TeeJet dealer for information on your specific setup or if there are any questions.

- Self-propelled – front mount
- Self-propelled – rear mount
- Three point hitch – front mount
- Three point hitch – rear mount
- Trailed – always rear mount

If using a self-propelled sprayer or spreader, use the GNSS offset adjustment calculation to calculate the implement lateral offset distance adjustment. If using a pull behind or trailed implement, use the Implement offset adjustment calculation to calculate the implement lateral offset distance adjustment. See the "Implement lateral offset distance adjustment" section of this chapter for more details.

Figure 6-29: Straight implement type with ISOBUS Sprayer



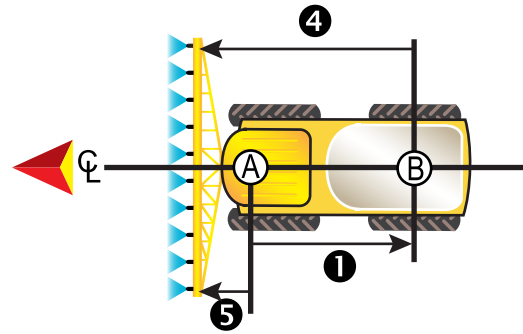

Self-propelled – front mount

Figure 6-30: Self-propelled – front mount





- Ⓐ – Centre of the GNSS antenna
- Ⓑ – Centre of the rear axle
- ① – Connection point in-line offset direction/distance
- ② – Connection point lateral offset direction/distance (not illustrated)
- ④ – B=Section X-offset distance
- ⑤ – Implement in-line offset direction/distance

ISOBUS Sprayer settings:

1. Press UNIVERSAL TERMINAL bottom tab .
2. From the Main setup screen , select **Machine**.
3. Select **OEM** then enter the access code as needed.
4. Select **Implement Geometry**.
5. Establish values for:
 - ▶ Connector type: **Selfpropelled - front**
 - ▶ B=Section X-offset ④ – measured in parallel to the centreline of the machine, define the distance from the centre of the rear axle ⑦ to the implement

Aeros settings:

1. Press SYSTEM SETUP bottom tab .
2. Press CONFIGURATION side tab .
3. Press **Implement**.
4. Select Implement type **Straight**.
5. Press Implement type NEXT PAGE arrow  to set up specific implement options.
6. Establish values for:
 - ▶ Connection point in-line offset direction ① – define the direction as **Forward** based on ISOBUS Sprayer connection type
 - ▶ Connection point in-line offset distance ① – measured in parallel to the centreline of the machine, define the distance from the GNSS antenna ① to the centre of the rear axle ⑦
 - ▶ Connection point lateral offset direction ② – define the direction, either left or right, from the centreline of the machine to the centre of the rear axle ⑦ while facing in the machine's forward direction

- ▶ Connection point lateral offset distance **2** – define the distance from the centreline of the machine to the centre of the rear axle **B**
- ▶ Implement in-line offset direction **1** – same direction as Aeros Connection point in-line offset direction
- ▶ Implement in-line offset distance **5** – calculated based on Aeros Connection point in-line offset distance **1** and ISOBUS Sprayer B=Section X-offset **4** entries
 - ▶ $4 - 1 = 5$
- ▶ Implement lateral offset direction **2** – same direction as Aeros Connection point lateral offset direction
- ▶ Implement lateral offset distance **2** – same value as on Aeros Connection point lateral offset distance

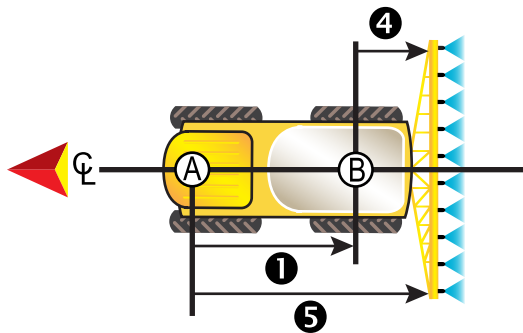

Self-propelled – rear mount

Figure 6-31: Self-propelled – rear mount





- A** – Centre of the GNSS antenna
- B** – Centre of the rear axle
- 1** – Connection point in-line offset direction/distance
- 2** – Connection point lateral offset direction/distance (not illustrated)
- 4** – B=Section X-offset distance
- 5** – Implement in-line offset direction/distance

ISOBUS Sprayer settings:

1. Press UNIVERSAL TERMINAL bottom tab .
2. From the Main setup screen , select **Machine**.
3. Select **OEM** then enter the access code as needed.
4. Select **Implement Geometry**:
5. Establish values for:
 - ▶ Connector type: **Selfpropelled - rear**
 - ▶ B=Section X-offset **4** – measured in parallel to the centreline of the machine, define the distance from the centre of the rear axle **B** to the implement

Aeros settings:

1. Press SYSTEM SETUP bottom tab .
2. Press CONFIGURATION side tab .
3. Press **Implement**.
4. Select Implement type **Straight**.
5. Press Implement type NEXT PAGE arrow  to set up specific implement options.

6. Establish values for:

- ▶ Connection point in-line offset direction **1** – define the direction as **Backward** based on ISOBUS Sprayer connection type
- ▶ Connection point in-line offset distance **1** – measured in parallel to the centreline of the machine, define the distance from the GNSS antenna **A** to the centre of the rear axle **B**
- ▶ Connection point lateral offset direction **2** – define the direction, either left or right, from the centreline of the machine to the centre of the rear axle **B** while facing in the machine's forward direction
- ▶ Connection point lateral offset distance **2** – define the distance from the centreline of the machine to the centre of the rear axle **B**
- ▶ Implement in-line offset direction **1** – same direction as Aeros Connection point in-line offset direction
- ▶ Implement in-line offset distance **5** – calculated based on Aeros Connection point in-line offset distance **1** and ISOBUS Sprayer B=Section X-offset **4** entries
 - ▶ $1 + 4 = 5$
- ▶ Implement lateral offset direction **2** – same direction as Aeros Connection point lateral offset direction
- ▶ Implement lateral offset distance **2** – same value as on Aeros Connection point lateral offset distance

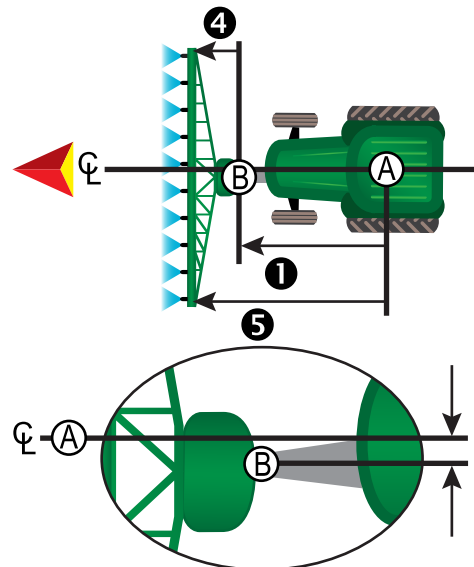

Three point hitch – front mount

Figure 6-32: Three point hitch – front mount





- A** – Centre of the GNSS antenna
- B** – Connection point
- 1** – Connection point in-line offset direction/distance
- 2** – Connection point lateral offset direction/distance
- 4** – B=Section X-offset distance
- 5** – Implement in-line offset direction/distance

ISOBUS Sprayer settings:

1. Press UNIVERSAL TERMINAL bottom tab .
2. From the Main setup screen , select **Machine**.
3. Select **OEM** then enter the access code as needed.
4. Select **Implement Geometry**:
5. Establish values for:
 - ▶ Connector type: **3-point hitch - front**
 - ▶ B=Section X-offset **4** – measured in parallel to the centreline of the machine, define the distance from point **(B)** to the implement

Aeros settings:

1. Press SYSTEM SETUP bottom tab .
2. Press CONFIGURATION side tab .
3. Press **Implement**.
4. Select Implement type **Straight**.
5. Press Implement type NEXT PAGE arrow  to set up specific implement options.
6. Establish values for:
 - ▶ Connection point in-line offset direction **1** – define the direction as **Forward** based on ISOBUS Sprayer connection type
 - ▶ Connection point in-line offset distance **1** – measured in parallel to the centreline of the machine, define the distance from the GNSS antenna **(A)** to point **(B)**
 - ▶ Connection point lateral offset direction **2** – define the direction, either left or right, from the centreline of the machine to the centre of point **(B)** while facing in the machine's forward direction
 - ▶ Connection point lateral offset distance **2** – define the distance from the centreline of the machine to point **(B)**
 - ▶ Implement in-line offset direction **1** – same direction as Aeros Connection point in-line offset direction
 - ▶ Implement in-line offset distance **5** – calculated based on Aeros Connection point in-line offset distance **1** and ISOBUS Sprayer B=Section X-offset **4** entries
 - ▶ **1 + 4 = 5**
 - ▶ Implement lateral offset direction **2** – same direction as Aeros Connection point lateral offset direction
 - ▶ Implement lateral offset distance **2** – same value as on Aeros Connection point lateral offset distance

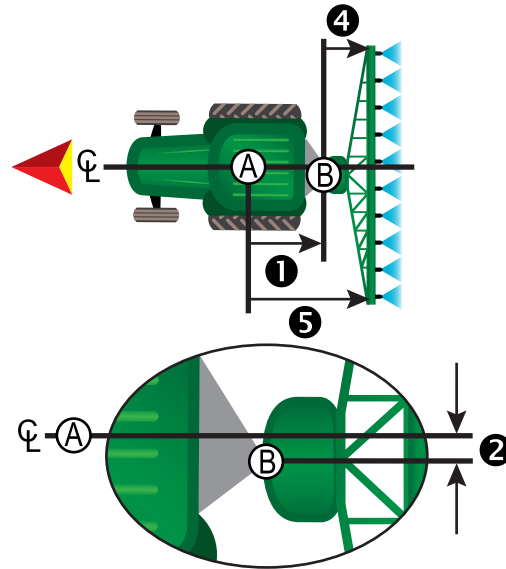

Three point hitch – rear mount

Figure 6-33: Three point hitch – rear mount





- (A)** – Centre of the GNSS antenna
- (B)** – Connection point
- 1** – Connection point in-line offset direction/distance
- 2** – Connection point lateral offset direction/distance
- 4** – B=Section X-offset distance
- 5** – Implement in-line offset direction/distance

ISOBUS Sprayer settings:

1. Press UNIVERSAL TERMINAL bottom tab .
2. From the Main setup screen , select **Machine**.
3. Select **OEM** then enter the access code as needed.
4. Select **Implement Geometry**:
5. Establish values for:
 - ▶ Connector type: **3-point hitch - rear**
 - ▶ B=Section X-offset **4** – measured in parallel to the centreline of the machine, define the distance from point **(B)** to the implement

Aeros settings:

1. Press SYSTEM SETUP bottom tab .
2. Press CONFIGURATION side tab .
3. Press **Implement**.
4. Select Implement type **Straight**.
5. Press Implement type NEXT PAGE arrow  to set up specific implement options.
6. Establish values for:
 - ▶ Connection point in-line offset direction **1** – define the direction as **Backward** based on ISOBUS Sprayer connection type
 - ▶ Connection point in-line offset distance **1** – measured in parallel to the centreline of the machine, define the distance from the GNSS antenna **(A)** to point **(B)**

- ▶ Connection point lateral offset direction **2** – define the direction, either left or right, from the centreline of the machine to point **B** while facing in the machine's forward direction
- ▶ Connection point lateral offset distance **2** – define the distance from the centreline of the machine to point **B**
- ▶ Implement in-line offset direction **1** – same direction as Aeros Connection point in-line offset direction
- ▶ Implement in-line offset distance **5** – calculated based on Aeros Connection point in-line offset distance **1** and ISOBUS Sprayer B=Section X-offset **4** entries
 - ▶ $1 + 4 = 5$
- ▶ Implement lateral offset direction **2** – same direction as Aeros Connection point lateral offset direction
- ▶ Implement lateral offset distance **2** – same value as on Aeros Connection point lateral offset distance

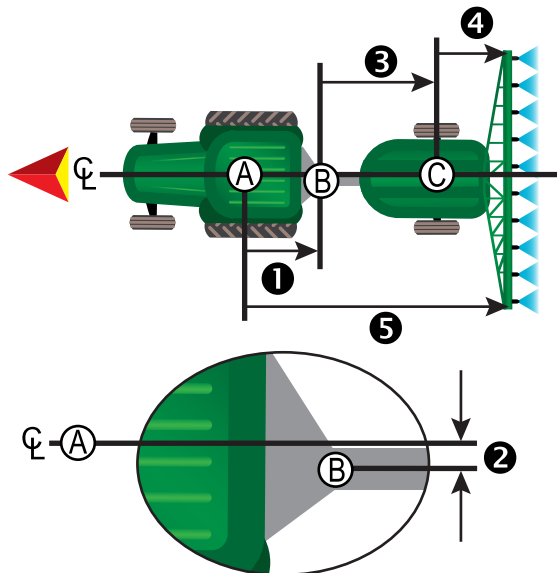

Trailed – always rear mount

Figure 6-34: Trailed – always rear mount





- A** – Centre of the GNSS antenna
- B** – Connection point
- C** – Centre of the front axle of the trailed implement
- 1** – Connection point in-line offset direction/distance
- 2** – Connection point lateral offset direction/distance
- 3** – A=Connection X-offset distance
- 4** – B=Section X-offset distance
- 5** – Implement in-line offset direction/distance

ISOBUS Sprayer settings:

1. Press UNIVERSAL TERMINAL bottom tab .
2. From the Main setup screen , select **Machine**.
3. Select **OEM** then enter the access code as needed.
4. Select **Implement Geometry** :
5. Establish values for:
 - ▶ Connector type: **Trailed**

- ▶ A=Connection X-offset **3** – measured in parallel to the centreline of the machine, define the distance from point **B** to the center of the front axle of trailed implement **C**
- ▶ B=Section X-offset **4** – measured in parallel to the centreline of the machine, define the distance from the center of the front axle of trailed implement **C** to the implement

Aeros settings:

1. Press SYSTEM SETUP bottom tab .
2. Press CONFIGURATION side tab .
3. Press **Implement**.
4. Select Implement type **Straight**.
5. Press Implement type NEXT PAGE arrow  to set up specific implement options.
6. Establish values for:
 - ▶ Connection point in-line offset direction **1** – define the direction as **Backward** based on ISOBUS Sprayer connection type
 - ▶ Connection point in-line offset distance **1** – measured in parallel to the centreline of the machine, define the distance from the GNSS antenna **A** to point **B**
 - ▶ Connection point lateral offset direction **2** – define the direction, either left or right, from the centreline of the machine to point **B** while facing in the machine's forward direction
 - ▶ Connection point lateral offset distance **2** – define the distance from the centreline of the machine to point **B**
 - ▶ Implement in-line offset direction **1** – same direction as Aeros Connection point in-line offset direction
 - ▶ Implement in-line offset distance **5** – calculated based on Aeros Connection point in-line offset distance **1**, ISOBUS Sprayer A=Connection X-offset **3** and ISOBUS Sprayer B=Section X-offset **4** entries
 - ▶ $1 + 3 + 4 = 5$
 - ▶ Implement lateral offset direction **2** – same direction as Aeros Connection point lateral offset direction
 - ▶ Implement lateral offset distance **2** – same value as on Aeros Connection point lateral offset distance

IMPLEMENT LATERAL OFFSET DISTANCE ADJUSTMENT

Implement lateral offset distance is used to enter the distance from the centreline of the machine to the centre of the implement. When on-screen mapping shows no overlap or gap, yet field application produces an overlap or gap consistently to only one side in the direction of travel, an adjustment to the Implement lateral offset distance should be calculated and made to the implement offset distance value.

If using a self-propelled sprayer or spreader, use the GNSS offset adjustment calculation to calculate the implement lateral offset distance adjustment.

If using a pull behind or trailed implement, use the Implement offset adjustment calculation to calculate the implement lateral offset distance adjustment.

NOTE: While using assisted/auto steering, if on-screen mapping shows overlaps and gaps, adjustments may need to be made to the assisted/auto steering settings.

Figure 6-35: Implement lateral offset distance

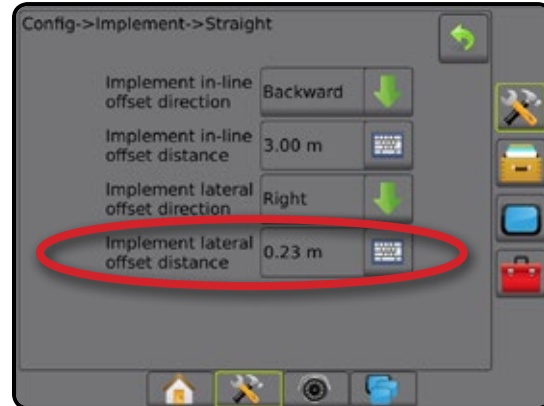

GNSS offset adjustment calculation

To calculate a GNSS offset adjustment using the same guideline:

1. Create a straight AB line.
2. With assisted/auto steering engaged, drive pass ① at least 100 feet / 30 meters, and place flags at the draw bar or next to the machine.
3. Turn around and engage assisted/auto steering on pass ② on the same AB guideline. Place flags at the draw bar or next to the machine, or stop while on the AB guideline next to the flags you placed on pass ①.
4. Measure the difference ③ between the flags of pass ① and pass ②.
5. Divide the measured distance ③ in half. This difference will be the offset adjustment.
6. Increase or decrease the offset distance as needed dependent on where the field application overlap occurs and the current implement offset direction setting.

Field application overlap	Current offset settings		
	Offset direction = left	Offset direction = right	Offset direction = right offset distance = 0 ft/m
To the right of pass ①	Increase distance offset value	Decrease distance offset value	Increase distance offset value
To the left of pass ①	Decrease distance offset value	Increase distance offset value	Change to implement offset direction to left and increase distance offset value

Figure 6-36: GNSS Offset Distance

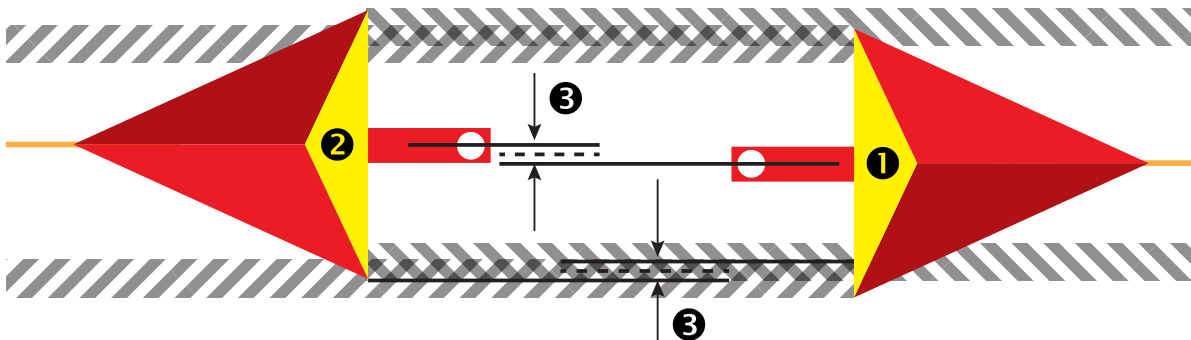

Implement lateral offset adjustment

To calculate an implement offset adjustment using adjacent guidelines:

1. Create a straight AB line.
2. With assisted/auto steering engaged, drive pass **1** as if you were operating the implement, and place flags at the outside edges of the implement.
3. Turn around and engage assisted/auto steering on pass **2** on the adjacent AB guideline. Place additional flags at the outside edges of the implement or stop while on the AB guideline next to the flags you placed on pass **1**.
4. Measure the difference **5** between the flags of pass **1** and pass **2**.
5. Divide the measured distance **5** in half. This difference will be the offset adjustment.
6. Increase or decrease the offset distance **4** as needed dependent on where the field application overlap occurs and the current implement offset direction setting.

Field application	Current offset settings		
	Offset direction = left	Offset direction = right	Offset direction = right offset distance = 0 m
Overlap on the right of pass 1 or Gap on the left of pass 1	Increase distance offset value	Decrease distance offset value	Increase distance offset value
Overlap on the left of pass 1 or Gap on the right of pass 1	Decrease distance offset value	Increase distance offset value	Change to implement offset direction to left and increase distance offset value

Figure 6-37: Implement lateral offset distance and direction

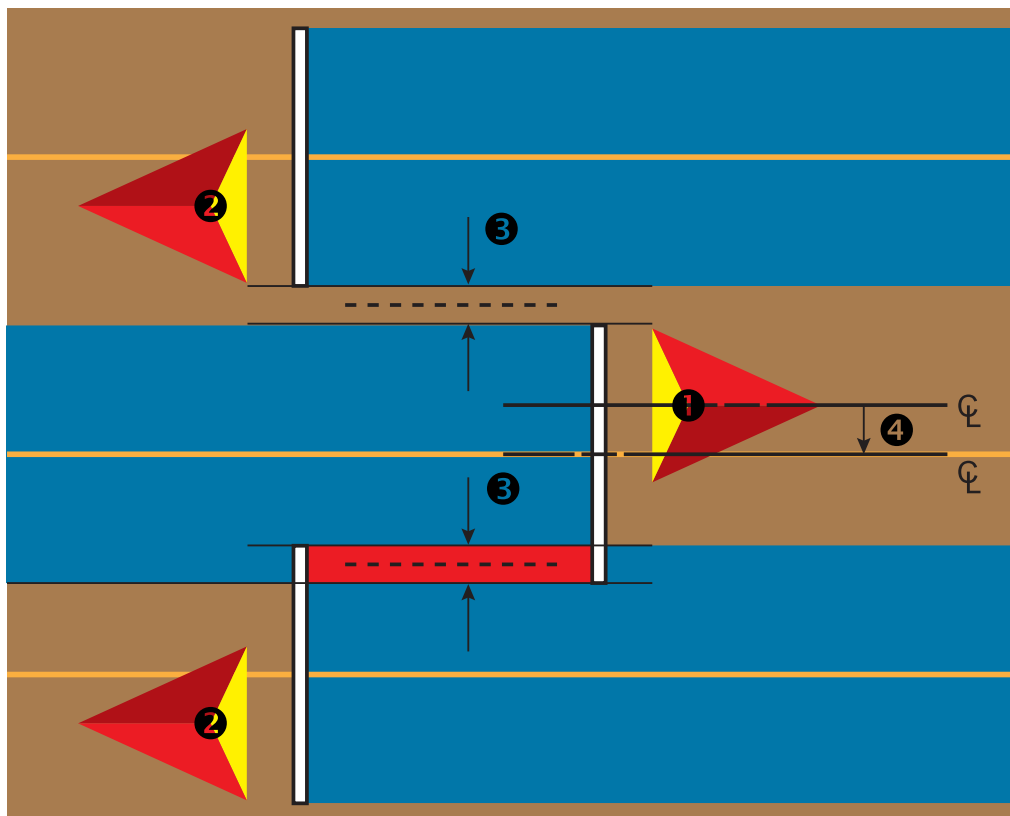

REVERSE SENSE

Reverse sense options are used when adding a Reverse sense module, SCM (Steering Control Module for FieldPilot IV) or SCM Pro (Steering Control Module Pro for FieldPilot Pro/UniPilot Pro) to any configuration. This allows for application mapping and control, and on-screen guidance when traveling in reverse.

1. Press CONFIGURATION side tab .
2. Press **Implement**.
3. In addition to standard options, select from:
 - ▶ Allow BoomPilot in reverse – used to enable BoomPilot function while traveling in reverse
 - ▶ Reverse signal delay – used to set the delay when going from forward to reverse or reverse to forward, after which the vehicle icon on a navigation screen changes direction

Figure 6-38: Reverse sense module



Reverse on guidance screens

While traveling in reverse, having BoomPilot in reverse active allows for product application, automatic section control, and mapping that is correct for reverse machine movement

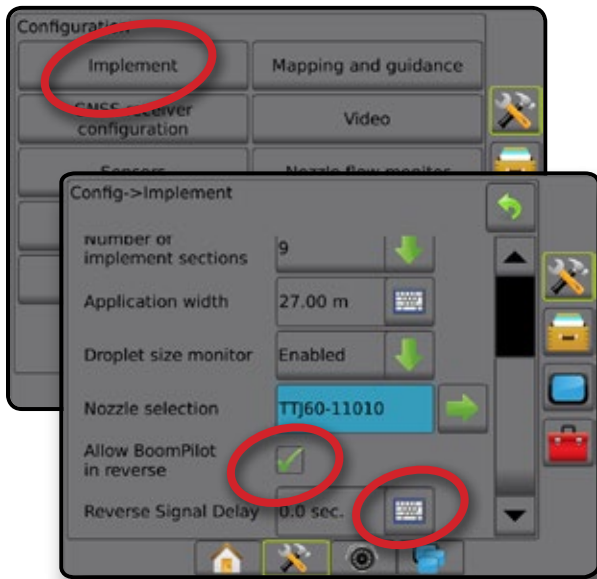
- ◀ Speed on the Guidance bar will turn red while traveling in reverse

Figure 6-39: Traveling forward

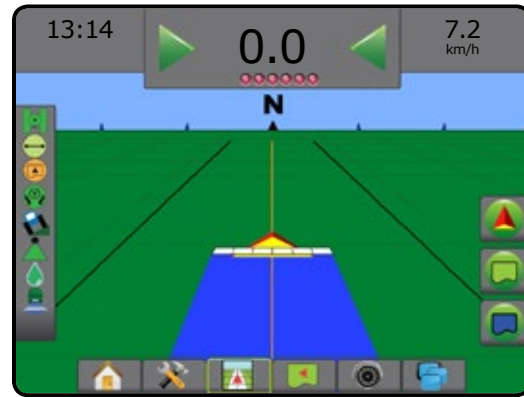
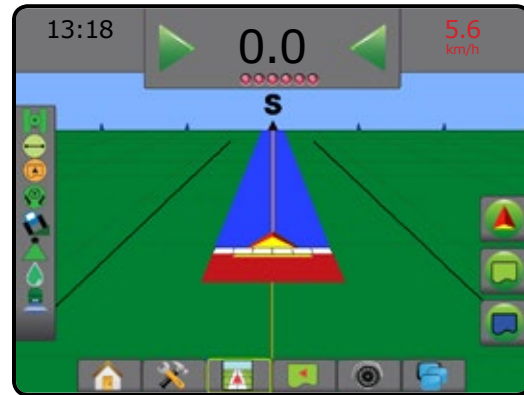

Figure 6-40: Traveling in reverse



Availability with different system configurations

Automatic Section Control device on system	Device sensing reverse vehicle movement	BoomPilot in reverse feature available	BoomPilot in reverse can be turned on/off in menu using Allow BoomPilot in reverse	Signal delay can be adjusted using Reverse signal delay
SDM or SFM	FieldPilot IV *	✓	✓	✓
	Reverse Sense Module	✓	✓	✓
	FieldPilot Pro / UniPilot Pro	✓	✓	✗**
IC18 Sprayer or IC34 Sprayer	FieldPilot IV *	✓***	✗	✗
	Reverse Sense Module	✓***	✗	✗
	FieldPilot Pro / UniPilot Pro	✓***	✗	✗**

* Optional function that is hardware dependent.

** Controlled directly by the FieldPilot Pro / UniPilot Pro.

*** Aeros consoles shipped from factory have the "Spray in Reverse" disabled by default. For TeeJet ISOBUS Implement ECU's, a USB Drive based settings app is required to change this to enabled, allowing to spray when in reverse.

NOZZLE SELECTION

When the system includes a Pressure sensor interface kit (PSIK), Nozzle selection is used to select the type of sprayer nozzle (series and capacity) for determining droplet size information.





1. Press CONFIGURATION side tab .
2. Press **Implement**.
 - ◀ Current nozzle section is shown in the information box
3. Press Nozzle selection NEXT PAGE arrow .
4. Select from:
 - ▶ Nozzle preset 1-5 – selects up to five (5) tips for quick recall, and selected the current nozzle for determining droplet size information
 - ▶ Current nozzle – displays the current nozzle
5. Press RETURN arrow  or CONFIGURATION side tab  to return to the main Configuration screen.

Figure 6-41: Droplet size monitor



Preset

Nozzle presets allow saving of up to five tips for quick recall.

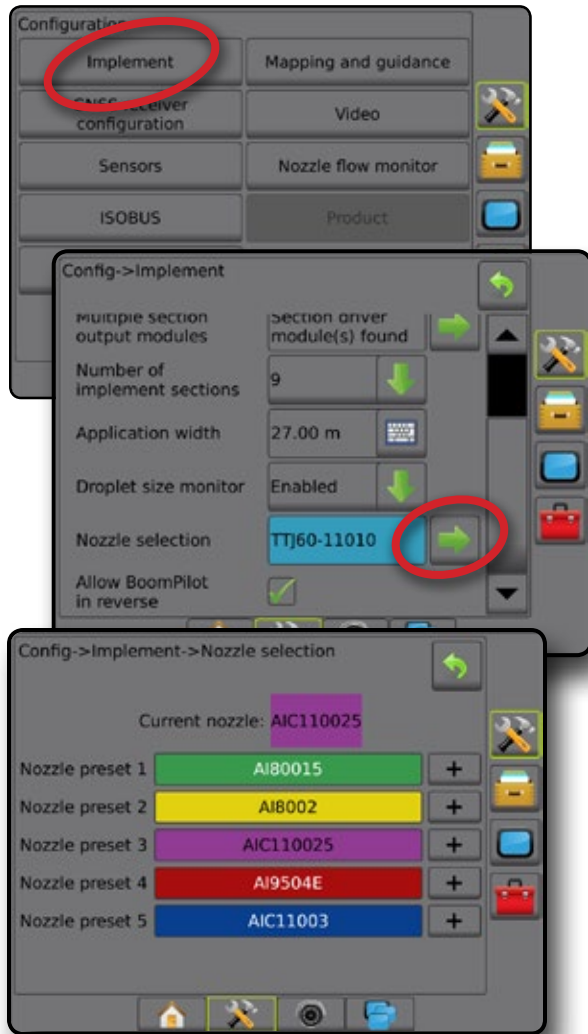
1. Press **+**.
2. Select a TeeJet nozzle series.
3. Select nozzle capacity.

Figure 6-42: Preset nozzle

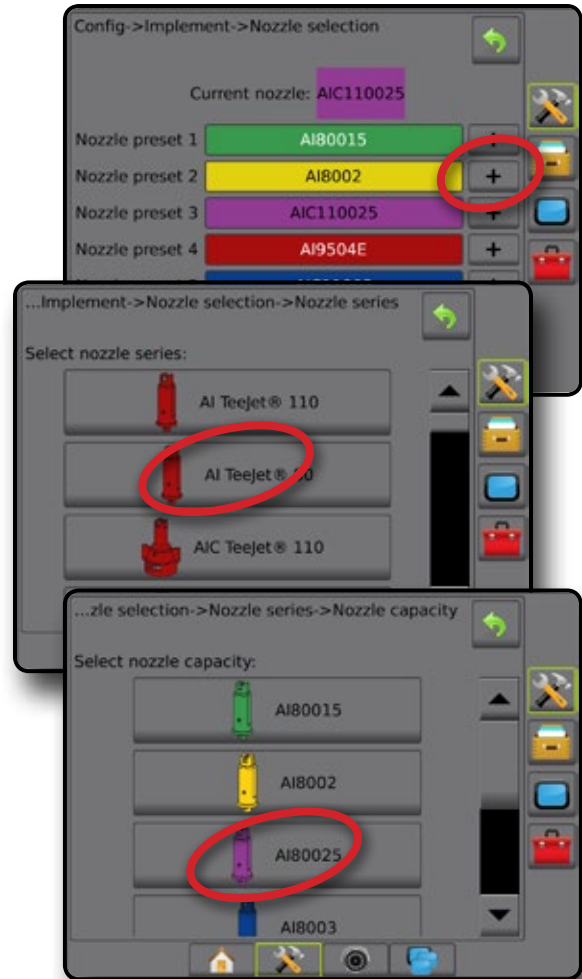

Nozzle sizes and associated colours

Established Nozzle Capacities and Colours			
Size	Color	Size	Color
01	Orange	06	Grey
015	Green	08	White
02	Yellow	10	Light Blue
025	Purple	12	Telemagenta
03	Blue	15	Light Green
04	Red	20	Black
05	Brown	30	Beige

Current nozzle

Current nozzle shows the active nozzle for determining current droplet size information. Tips must be preset to be available for current nozzle selection.

1. Press desired nozzle.

Selected nozzle will be shown:

- ◀ The information box on the Implement screen
- ◀ The Droplet/pressure status display from the status bar on the guidance screens

Figure 6-43: Current nozzle



DROPLET SIZE MONITOR

When the system includes a Pressure sensor interface kit (PSIK), Droplet size monitor can be enabled/disabled. The DSM then becomes available on the operation screens.

Setup

Enable/disable DSM

1. Press CONFIGURATION side tab
2. Press **Implement**.
3. Press **Droplet size monitor**.
4. Select if droplet size monitor is enabled or disabled.
5. Press RETURN arrow or CONFIGURATION side tab to return to the main Configuration screen.

NOTE: When Droplet size monitor is disabled, the Droplet/pressure status is not available on the guidance screen status bar.

Figure 6-44: Droplet size monitor

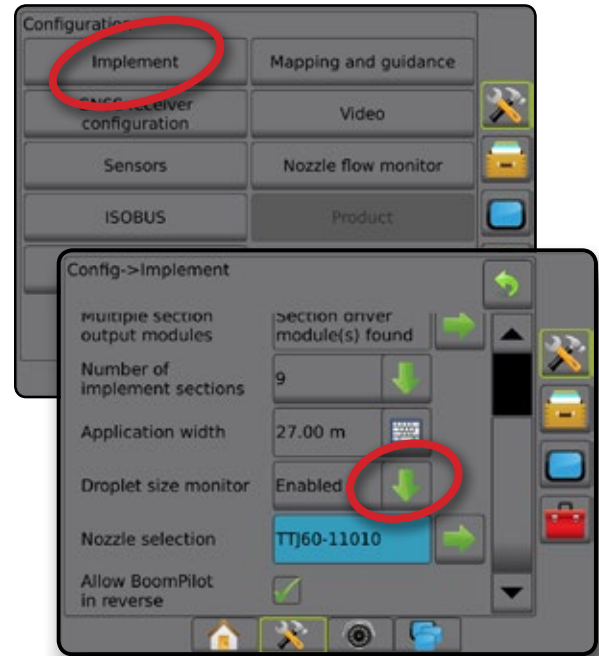

Nozzle selection / current nozzle

To establish the nozzle presets and current nozzle, see "Nozzle selection" in this chapter.

Input/output module pressure sensor

When a Pressure sensor interface kit is present, Pressure sensor options are used to enter the sensor manufacturer's maximum pressure rating and set high and low user determined pressure alarms.

NOTE: For more information, see "Sensors" in the Setup chapter of this manual.

Operation

Status bar

Droplet/pressure status displays information regarding the current status of the droplet size and system pressure.





1. Press DROPLET/PRESSURE STATUS icon .
2. Press the screen anywhere to return to the guidance screen.

Figure 6-45: Droplet/pressure status

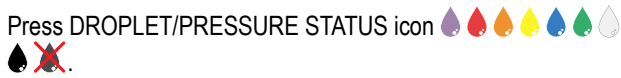
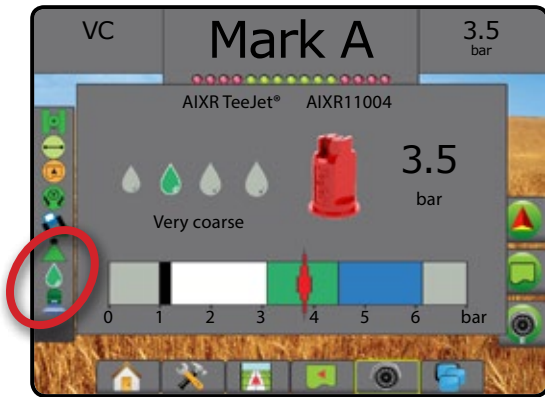

Droplet/pressure status

-  Colored = engaged. The colour of the droplet is directly associated with the current droplet size. Colour options include: 
-  Crossed out = disabled
- No icon = no Pressure sensor interface kit is installed on system

Droplet size chart

When choosing a spray nozzle that produces droplet sizes in one of the eight droplet size classification categories, always remember that a single nozzle can produce different droplet size classifications at different pressures. A nozzle might produce medium droplets at low pressures, while producing fine droplets as pressure is increased.

Category	Symbol	Colour code
Extremely fine	XF	Violet
Very fine	VF	Red
Fine	F	Orange
Medium	M	Yellow
Coarse	C	Blue
Very coarse	VC	Green
Extremely coarse	XC	White
Ultra coarse	UC	Black

Guidance bar

The Guidance bar keeps you informed of your choice of selectable information including current system pressure and current droplet size.

1. Press SELECTABLE INFORMATION box.
2. Select from:
 - ▶ System pressure – displays the current system pressure
 - ▶ Droplet size – displays the current nozzle droplet size
3. Press outside the selection box to return to the guidance screen.

Figure 6-46: Guidance bar selectable information

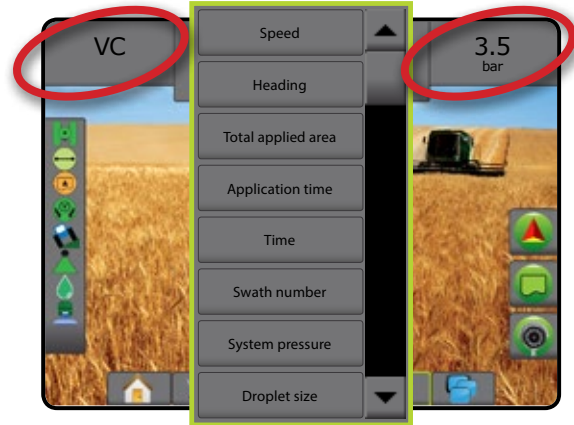

BOOMPILOT SECTION CONTROL

Depending on if there is a section control system present and, when present, what kind of section control is being used as well as what options are enabled, there are multiple options for BoomPilot section control. The settings of BoomPilot Start mode and BoomPilot icon change how section control is handled on the guidance screens.



1. Press CONFIGURATION side tab .
2. Press **Implement**.
3. Select from:
 - ▶ BoomPilot start mode – used to establish if automatic BoomPilot activation is controlled automatically by speed or manually using the BoomPilot icon in the navigation and guidance options on the guidance screens
 - ◀ Automatic – automatic section control will be controlled by speed
 - ◀ Off – automatic section control is disabled and can be manually controlled by the BoomPilot icon in the navigation and guidance options on the guidance screens
 - ▶ BoomPilot icon – used to establish if the BoomPilot icon is available in the navigation and guidance options on the guidance screens for manually controlling BoomPilot
 - ◀ Enable – BoomPilot icon will be available in the navigation and guidance options on the guidance screens to control automatic section control
 - ◀ Disable – BoomPilot icon will not be available in the navigation and guidance options
4. Press RETURN arrow  or CONFIGURATION side tab  to return to the main Configuration screen.

Figure 6-47: BoomPilot options

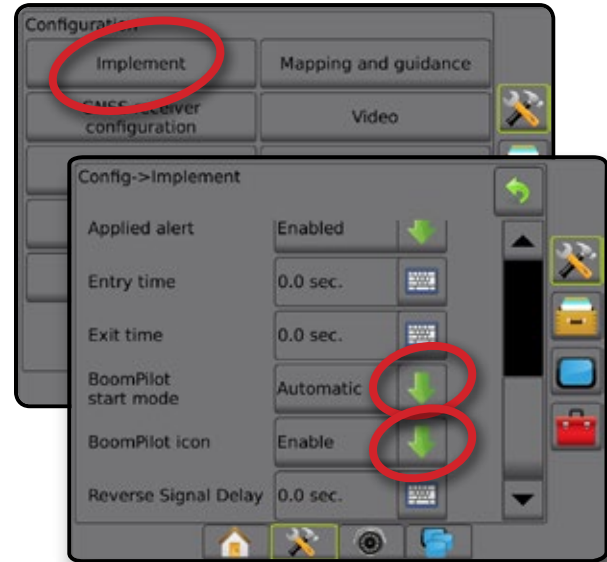

Figure 6-48: BoomPilot icon on guidance screen



Availability with different hardware systems

Hardware on System	BoomPilot start mode		BoomPilot icon		
	Available on Configuration-> Implement menu	Works when in guidance screens	Available on Configuration-> Implement menu	Changes what is available on Navigation and guidance options	Works when in guidance screens
SDM/SFM Only (no TeeJet ASB SwitchBox)	Yes	Yes	Yes	Yes	Yes
SDM + TeeJet ASB Switchbox	No	No	No	No	No
SFM + ISM	Yes	Yes	Yes	Yes	Yes
IC18 Sprayer + ISO Switchbox	Yes	Yes	Yes	No, always available	Yes

CHAPTER 7 – GUIDANCE AND MAPPING

The Aeros 9040 allows product application and vehicle guidance to be performed simultaneously. Once system setup is complete, guidance can begin. Six guidance modes allow users to optimize the field work: Straight AB (→), Curved AB (↷), Circle pivot (⊙), Last pass (↶), NextRow (↵) and Adaptive Curve (↻). Additional optimization can be accomplished with Interior boundary (⊞), Exterior boundary (⊞) and/or Polygon (⊞) application; Curved lookahead (↷); Return to point (⊞); and RealView guidance over video (📹). In addition, Coverage (📊) and Application (📊) mapping functions can display and record product application, and Prescription (📊) and Target rate (📊) maps can direct product application.

Overview

Three guidance screens assist in keeping you informed.

Vehicle view guidance creates a computer-generated image of the vehicle position displayed in the application area.

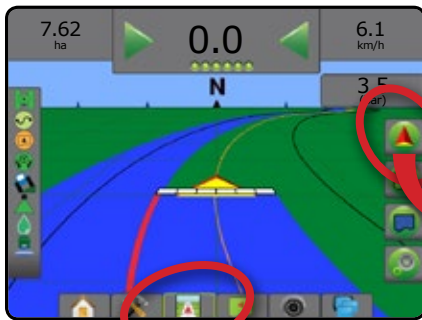



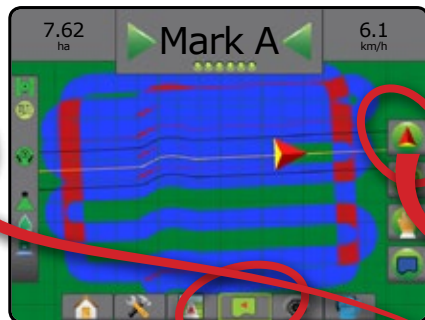





Field view guidance creates a computer-generated image of vehicle position and application area from an aerial perspective.



RealView guidance allows live video input to be displayed instead of a computer-generated image.



To choose a guidance mode:

1. Press NAVIGATION AND GUIDANCE OPTIONS tab  to display navigation options.
2. Press GUIDANCE MODE icon .
3. Select from:
 - ▶ No guidance 
 - ▶ Straight AB guidance 
 - ▶ Curved AB guidance 
 - ▶ Circle Pivot guidance 
 - ▶ Last Pass guidance* 
 - ▶ NextRow guidance* 
 - ▶ Adaptive curve guidance 

**Guidance options may not be available depending on assisted/automatic steering system installed.*

Figure 7-1: Choose a guidance mode



Screens options

Guidance and navigation can be accessed from the Vehicle view screen, Field view screen, or RealView screen.







- Navigation and guidance options tab  – on any guidance screen, displays navigation options including guidance modes, guideline options, return to point options, refresh GNSS, BoomPilot toggle, curved lookahead toggle and nozzle flow monitor reset.
- Boundary & polygon options tab  – on any guidance screen, displays exterior boundary, interior boundary and polygon options.
- Mapping options tab  – on vehicle view or field view guidance screens, displays polygon maps, coverage maps and application maps.
- Application options tab  – on vehicle view guidance screen, displays ISOBUS Sprayer application options.
- Screen options tab  – on field view guidance screen, displays zoom and pan options.
- RealView options tab  – on RealView guidance screen, displays camera setup and guidance over video options.

Figure 7-2: Guidance screen options







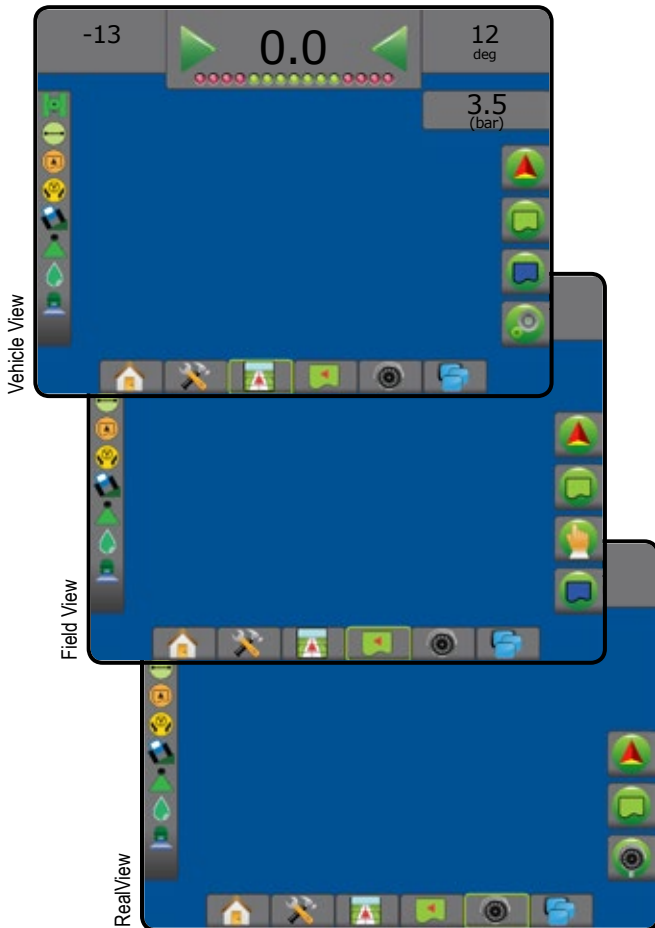
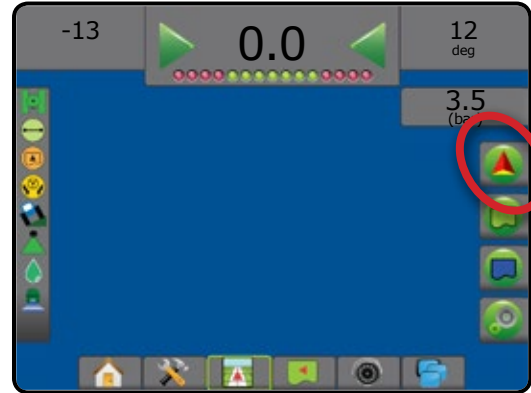









Navigation and guidance options

On any guidance screen, displays navigation options including guidance modes, guideline options, return to point options, refresh GNSS, BoomPilot toggle, curved lookahead toggle and nozzle flow monitor reset.



Guidance mode

	Guidance mode – access to guidance mode options
	No guidance – turns off guidance
	Straight AB guidance  – provides straight-line guidance based on A and B reference points
	Curved AB guidance  – provides guidance along curved lines based on an initial AB reference line
	Circle pivot guidance  – provides guidance around a central location that radiates inward or outward based on an initial AB reference line
	Last pass guidance  – offers true last-pass navigation
	NextRow guidance  – indicates where the NextRow is located, and provides guidance at row ends to the next adjacent row
	Adaptive curve guidance  – provides guidance along a curved line based on an initial AB reference line where each adjacent guideline is drawn from the projected guidance width and heading

BoomPilot

	Toggles the Automatic section control (ASC) on or off. Greyed = GNSS is unavailable.
---	--

Curved lookahead

	Indicates where the current steering will take the vehicle using a 'pointer' as guidance.
---	---

Guidelines	
	Mark A – marks the first point of the guideline.
	Mark B – marks the end point of the guideline. Greyed = minimum distance has not been travelled.
	Cancel mark A – cancels the Mark A process. Reverts to previous AB guideline (when established).
	NextRow mark B – marks the end point of the row.
	Azimuth degree – establishes a straight guideline measured by degrees clockwise from a north-south baseline. North = 0, East = 90, South = 180, West = 270.
	A+ nudge – shifts the existing guideline to the vehicle's current position.
	Next straight guideline – shows the next straight AB or Azimuth degree guideline saved in the current job.
	Next curved AB guideline – shows the next Curved AB guideline saved in the current job.
	Next circle pivot guideline – shows the next Circle pivot AB guideline saved in the current job.
	Next adaptive curve guideline – shows the next Adaptive Curve AB guideline saved in the current job.

Return to Point	
	Mark point – establishes a point at the vehicle location. Greyed = GNSS is unavailable.
	Return to point guidance – provides distance and guidance back to an established point.
	Delete point – deletes the Marked Point.
	Cancel guidance – hides the distance and guidance back to the marked point.

Nozzle fault reset	
	Clears any nozzle fault indications.

Refresh GNSS position	
	Resets the ClearPath filter in the OEMStar receiver.



Boundary and polygon options

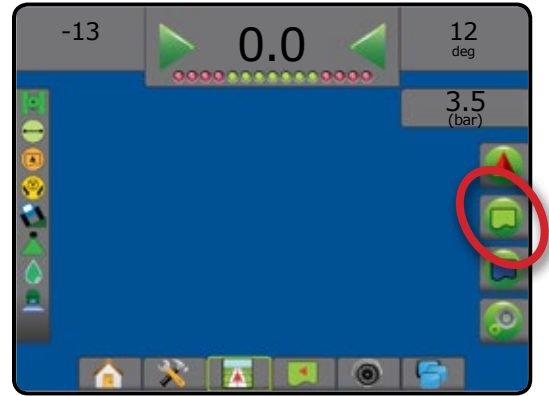





On any guidance screen, displays exterior boundary, interior boundary and polygon options.



Exterior boundaries	
	Mark exterior boundary – establishes application area and determines no-apply zones. While creating an exterior boundary, the boundary line will be to the exterior of the outer-most section. Greyed = GNSS is unavailable.
	Cancel exterior boundary – cancels mark exterior boundary process
	Finish exterior boundary – finalizes current mark exterior boundary process. Boundaries can also be closed by travelling to within a swath width of the starting point.
	Pause exterior boundary – pauses the mark exterior boundary process
	Resume exterior boundary – resumes the mark exterior boundary process
	Delete last marked boundary – deletes the last marked boundary (interior or exterior) from the current job. Press again to remove additional boundaries in order from last to first created

Interior boundaries	
	Mark interior boundary – establishes application area and determines no-apply zones. While creating an interior boundary, the boundary line will be to the interior of the inner-most section. Greyed = GNSS is unavailable.
	Cancel interior boundary – cancels current mark interior boundary process
	Finish interior boundary – finalizes current mark interior boundary process. Boundaries can also be closed by travelling to within a swath width of the starting point

	Pause interior boundary – pauses the mark interior boundary process
	Resume interior boundary – resumes the mark interior boundary process
	Delete last marked boundary – deletes the last marked boundary (interior or exterior) from the current job. Press again to remove additional boundaries in order from last to first created





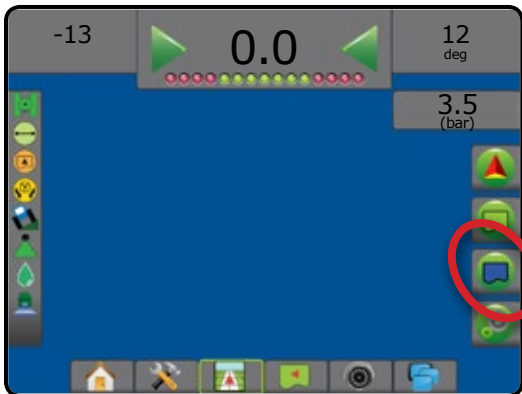

Polygons	
	Mark polygon – establishes mapping areas. Greyed = GNSS is unavailable.
	Cancel polygon – cancels current mark polygon process
	Finish polygon – finalizes current mark polygon process
	Pause polygon – pauses the mark polygon process
	Resume polygon – resumes the mark polygon process
	Delete last marked polygon – deletes the last marked polygon from the current job. Press again to remove additional polygons in order from last to first created

Mapping options

On vehicle view or field view guidance screens, displays polygon maps, coverage maps and application maps.

NOTE: Options are available only when a rate controller is on the system or a polygon has been established.







	Prescription map – shows pre-loaded map that provides information to the rate controller for use in applying product	
	Application map – shows where product has been applied, using colour to indicate level in proportion to preset maximum and minimum levels	
	Target rate map – shows the application rate that the rate controller will attempt to achieve	
	Vehicle view – icons adjust the vehicle's view or perspective to the horizon from vehicle view to bird's-eye view.	
	Field view – icons increase/decrease the area displayed on the screen.	

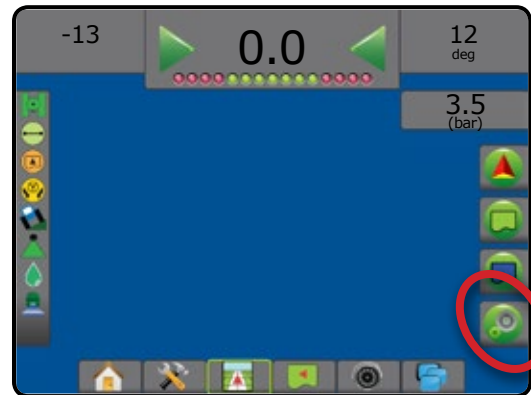

Application control options

On vehicle view guidance screen, displays ISOBUS Sprayer application options.

NOTE: Options are available only when a ISOBUS Sprayer rate controller is on the system.



	Target rate percentage increase – establishes the required boost percentage step increase
	Target rate percentage decrease – establishes the required boost percentage step decrease
	Percentage boost and reset – shows current boost percentage step and when pressed, zeros the boost percentage step

	Coverage map – shows areas covered by the implement, regardless of whether product was applied.
	Polygon map – shows all mapped polygons



Screen options

On field view guidance screen, displays zoom and pan options.

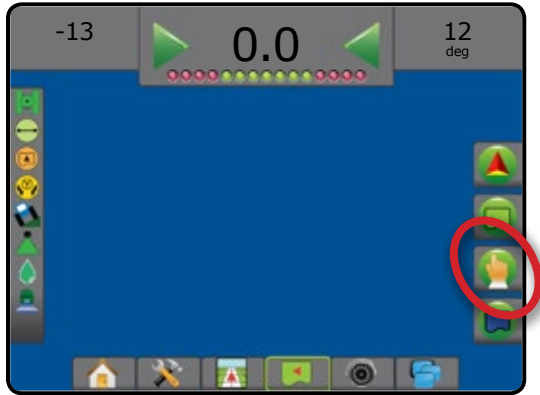

Zoom In/Out



Vehicle view – icons adjust the vehicle's view or perspective to the horizon from vehicle view to bird's-eye view.



Field view – icons increase/decrease the area displayed on the screen.



Pan



Arrows – move the displayed map area in the corresponding direction without moving the vehicle.



World view – extends the screen view to the widest area available.



RealView guidance options

On RealView guidance screen, displays camera setup and guidance over video options.

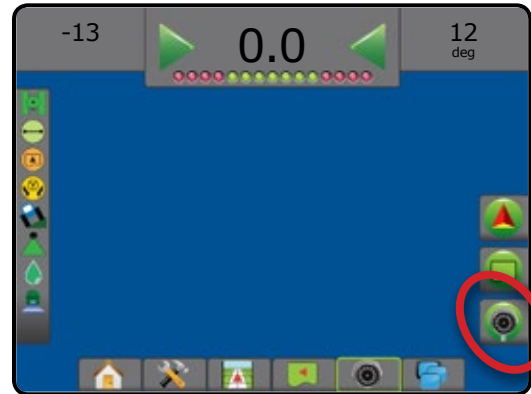

Video camera select – selects one of up to eight camera views if a Video selection module (VSM) is attached.



Split camera view – selects one of two sets of four camera inputs (A/B/C/D or E/F/G/H) to divide the screen into four separate video feeds.



Guidance over video setup – access to turn on Guidance over video or Steering angle and adjust guidelines.



Guidance over video – places three-dimensional guidelines over the video feed for navigational assistance.



Steering angle – displays the direction in which the steering wheel needs to be adjusted.



Up & down icons – used to adjust the guidance lines and horizon line to match the camera's view.



Camera image capture – saves a still photo of the current view on the screen to a USB drive.

GUIDANCE BAR

The Guidance bar keeps you informed of your choice of selectable information, navigation activity, and section status.

Navigation activity & Boom status

GNSS status – displays “No GNSS” when GNSS is unavailable, or “Slow GNSS” when GNSS is receiving GGA data at less than 5Hz

Cross track error – displays the distance from your desired guideline

Current activity – displays activities such as mark an A or B point, approaching the end of a row, indicating to turn now, and distance to return to a marked point

Section status – one dot is displayed for each section programmed: a green dot indicates the section is active, and a red dot indicates the section is not active

Figure 7-3: Navigation activity/section status



Cross track error

The distance around the guideline that is perceived as zero error can be adjusted using Configuration-> Guidance-> Guidance sensitivity.

To change the format in which the distance is displayed:

1. Press the Navigation activity box on the guidance bar.
2. Select the measurement format.

Selectable Information

Speed – displays the current speed of travel

Heading – displays the course of travel based clockwise from a true north baseline. North = 0°, East = 90°, South = 180°, West = 270°.

Total applied area – displays the total accumulated area that has had product applied, including double-coverage areas

Application time – displays the total time application is active during the current job

Time – displays the current time based on the selected time zone

Swath number – displays the current swath number in reference to the initial AB guidance line, facing in the direction from A to B. Number will be positive when the vehicle is to the right of the AB baseline, or negative when the vehicle is to the left of the AB baseline.

System pressure – displays the current system pressure (available only when an Input/Output Module is on the system)

Droplet size – displays the current nozzle droplet size (available only when an Input/Output Module is on the system)

Actual application rate – displays the current application rate (available only when a rate controller is on the system)

Target application rate – displays the target application rate (available only when a rate controller is on the system)

Volume/product applied – displays the volume or weight of product applied (available only when a rate controller is on the system)

Tank/bin amount remaining – displays the volume or weight of product remaining in the tank/bin (available only when a rate controller is on the system)

Figure 7-4: Selectable information



STATUS BAR

The Status bar provides information on GNSS status, guidance mode, exterior boundary area, assisted/auto steering engagement, tilt correction, implement control status, droplet/pressure status, and nozzle flow status.

When an icon is pressed, the related status information is displayed.

Figure 7-5: Status bar

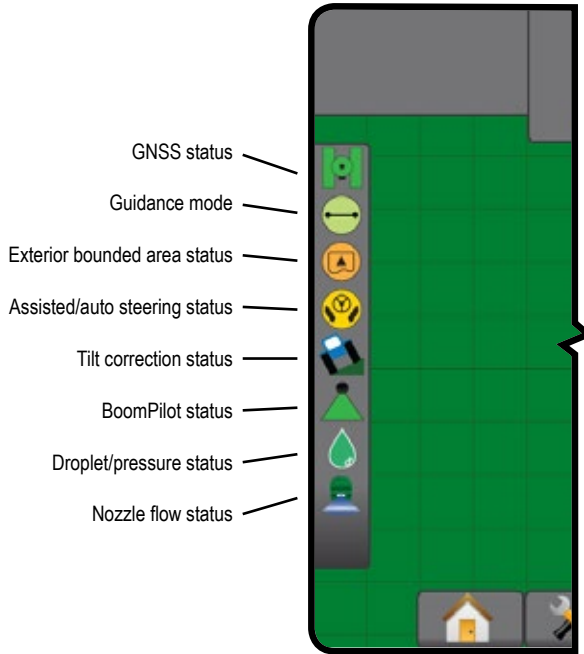

GNSS status

- Green = GPS, GLONASS, or SBAS (with or without DGPS Required)
- Yellow = GPS only
- Red = no GNSS
- Orange = Glide/ClearPath

Guidance mode

- No icon = no guidance
- Straight AB guidance
- Curved AB guidance
- Circle pivot guidance
- Last pass guidance
- NextRow guidance
- Adaptive curve guidance

Bounded area status

- Outside exterior boundary = traveling outside exterior bounded area
- Inside exterior boundary = traveling inside exterior bounded area
- No icon = no boundary established (exterior or interior)

Assisted/auto steering status

- Green = engaged, actively steering
- Yellow = enabled, all conditions have been met to allow for assisted/auto steering
- Red = disabled, all conditions have not been met to allow for assisted/auto steering
- No icon = no assisted/auto steering system installed

Tilt correction status

- Coloured = engaged, actively applying tilt correction
- Red = disabled
- No icon = no tilt gyro module installed on system, or tilt is associated with assisted/auto steering system

BoomPilot status

- Green = automatic
- Yellow = all on
- Red = off/manual
- No icon = single section (no SmartCable or SDM installed on system)

Droplet/pressure status

- Coloured = engaged. The colour of the droplet is directly associated with the current droplet size. Colour options include:
- Crossed out = disabled
- No icon = no Pressure sensor interface kit installed, no pressure sensor monitor on the DCM

Nozzle flow status

- Green = nozzle flow system calibrated with no nozzle errors
- Red = nozzle flow imbalance: flow is higher or lower than the nozzle alarm threshold
- No icon = no nozzle flow monitor hardware detected

Status/information screens

GNSS status

GNSS Status displays information regarding current GNSS status, including data rates, number of satellites in view, HDOP and PRN status, receiver and version, satellite quality and ID, and UTM zone.

1. Press GNSS STATUS icon

Figure 7-6: GNSS status

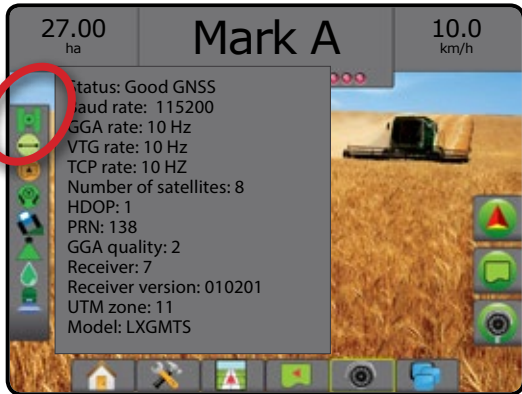

Guidance mode status

Guidance mode status displays information regarding the pattern of guidance, the name of the current guideline, and how many guidelines are saved in the console.

1. Press GUIDANCE MODE icon

Figure 7-7: Guidance mode status

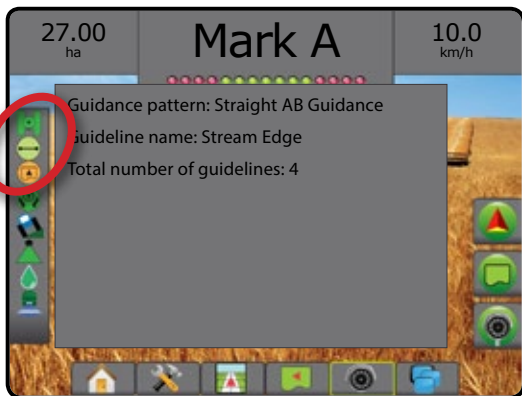

Bounded area status

Bounded area status displays information regarding the areas in the current exterior and interior boundaries.

1. Press BOUNDED AREA icon

 - ◀ Working area – total area of all exterior boundaries
 - ◀ Field area – total area of all exterior boundaries minus the area of all interior boundaries
 - ◀ Internal area – total area of all interior boundaries

Figure 7-8: Bounded area status



Assisted/auto steering status

Assisted/auto steering status displays information regarding the current status of the assisted/auto steering system, including tilt status.

1. Press ASSISTED/AUTO STEERING STATUS icon

Figure 7-9: Assisted/auto steering status

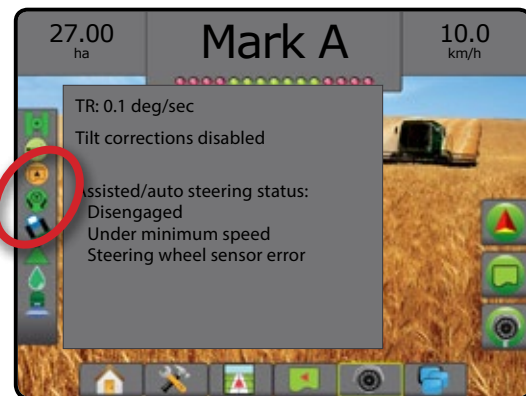

Tilt correction status

Tilt correction status displays information regarding the current status of the tilt correction system.

1. Press TILT CORRECTION STATUS icon .

Figure 7-10: Tilt correction status

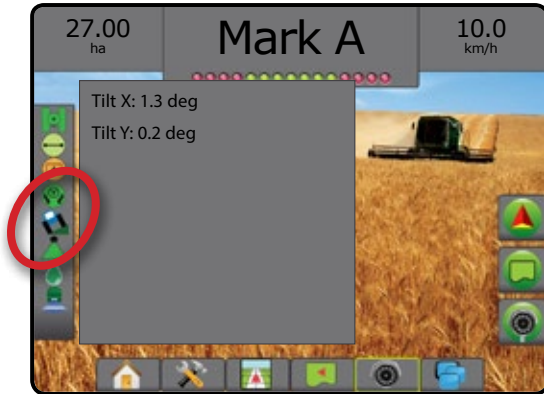

Droplet/pressure status

Droplet/pressure status displays information regarding the current status of the droplet size and system pressure.

1. Press DROPLET/PRESSURE STATUS icon .

Figure 7-12: Droplet/pressure status

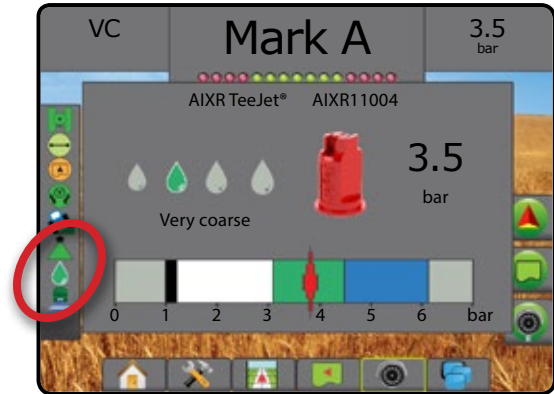

BoomPilot status

BoomPilot status displays information regarding the current status of the BoomPilot system.

1. Press BOOMPILOT STATUS icon .

Figure 7-11: BoomPilot status

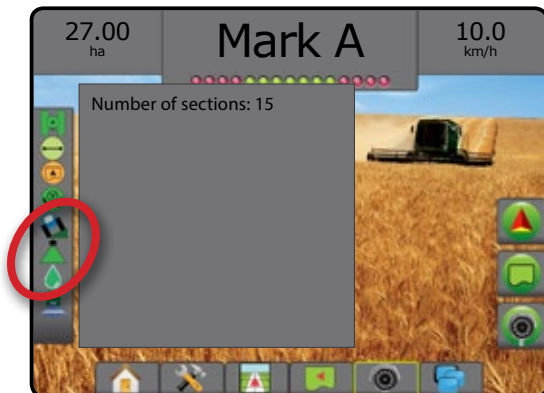

Nozzle flow status

Nozzle flow status displays information regarding the current status of the Nozzle flow system and how many nozzles are detected on the system.

1. Press Nozzle FLOW STATUS icon .

Figure 7-13: Nozzle flow status

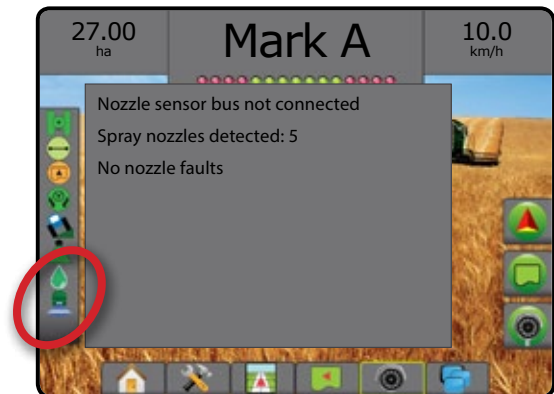

Aeros 9040 field computer

NAVIGATION SCREENS

Vehicle view

Vehicle view creates a computer-generated image of the vehicle position displayed in the application area. From this screen all setup, boundary, polygon, mapping, application and navigation options can be accessed via the options tabs on the right side of the screen.

To access the Vehicle view screen:

1. Press VEHICLE VIEW GUIDANCE tab .

Figure 7-14: Vehicle view

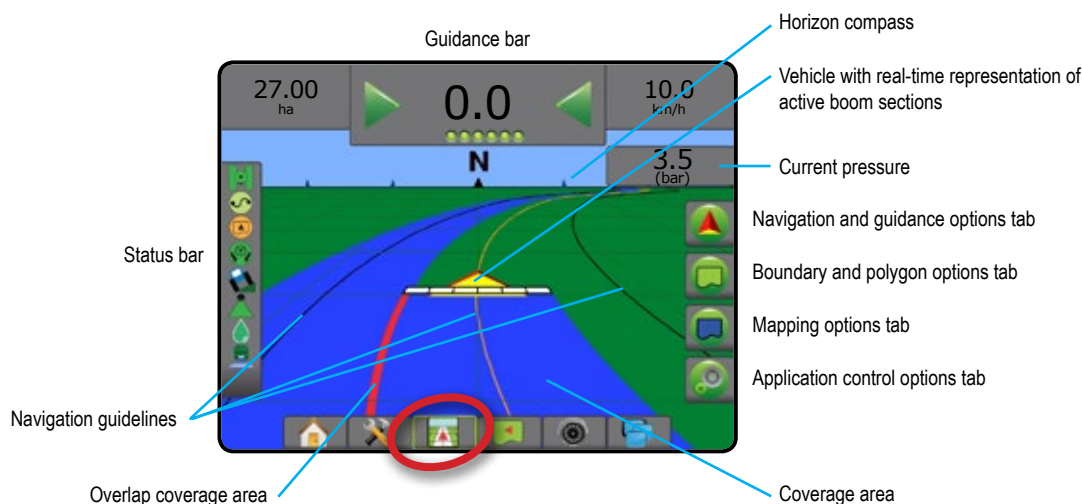

On screen guidance

- Guidelines
 - ◀ Orange – active guidance line
 - ◀ Black (multiple) – adjacent guidance lines
 - ◀ Black – exterior boundary line
 - ◀ Grey – interior boundary line
 - ◀ Blue – polygon boundary line
 - ◀ Black/white – prescription map zone boundary line
- Points – markers for established points
 - ◀ Red point – Return to point
 - ◀ Blue point – Mark A
 - ◀ Green point – Mark B
- Horizon compass – general heading can be displayed on horizon (when zoomed in)
- Coverage area – illustrates applied area and overlap:
 - ◀ Blue – one application
 - ◀ Red – two or more applications
 - ◀ User selected – Application map and Target rate map applied areas show coloured bars relative to selected colour range and map selection.
- Sections
 - ◀ Empty boxes – inactive sections
 - ◀ White boxes – active sections

Field view

Field view creates a computer-generated image of the vehicle position and application area from an aerial perspective. From this screen, all setup, boundary, polygon and navigation options, as well as Pan mode and mapping options, can be accessed via the option tabs on the right side of the screen.

To access the Field view screen:

1. Press FIELD VIEW GUIDANCE tab .

Figure 7-15: Field view

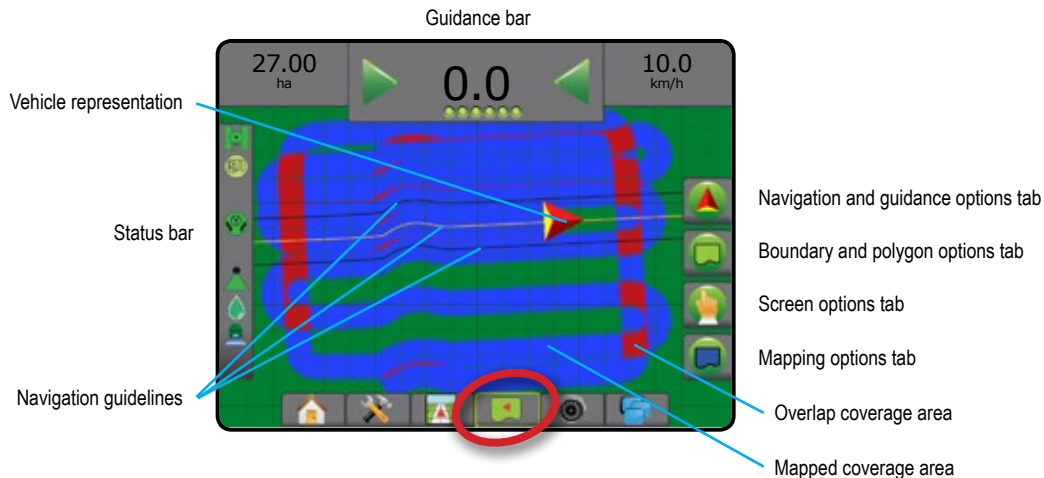

On screen guidance

- Guidelines
 - ◀ Orange – active guidance line
 - ◀ Black (multiple) – adjacent guidance lines
 - ◀ Black – exterior boundary line
 - ◀ Grey – interior boundary line
 - ◀ Blue – polygon boundary line
 - ◀ Black/white – prescription map zone boundary line
- Points – markers for established points
 - ◀ Red point – Return to point
 - ◀ Blue point – Mark A
 - ◀ Green point – Mark B
- Coverage Area – illustrates applied area and overlap
 - ◀ Blue – one application
 - ◀ Red – two or more applications
 - ◀ User selected – Application map and Target rate map applied areas show coloured bars relative to selected colour range and map selection.

Aeros 9040 field computer

INTRODUCTION

HOME

FULL SCREEN

SETUP

GNSS

IMPLEMENT

GUIDANCE

RATE CONTROL

APPENDIX

RealView guidance

 RealView guidance allows live video input to be displayed instead of a computer-generated image. From this screen all setup, boundary, polygon and navigation options can be accessed via the tabs on the right side of the screen. To adjust the camera view [reverse, upside down], go to Setup-> Configuration-> Video.

- ▶ Single camera – a single camera is directly attached to the console
- ▶ Video selection module – if a Video selection module (VSM) is installed on the system, two (2) video options are available:
 - One camera view – one of up to eight camera inputs can be selected to change the view of the video input.
 - Split camera view – one of two sets of four camera inputs (A/B/C/D or E/F/G/H) can be selected to divide the screen into four separate video feeds.

To access the RealView screen:

1. Press REALVIEW GUIDANCE tab .

Figure 7-16: RealView guidance

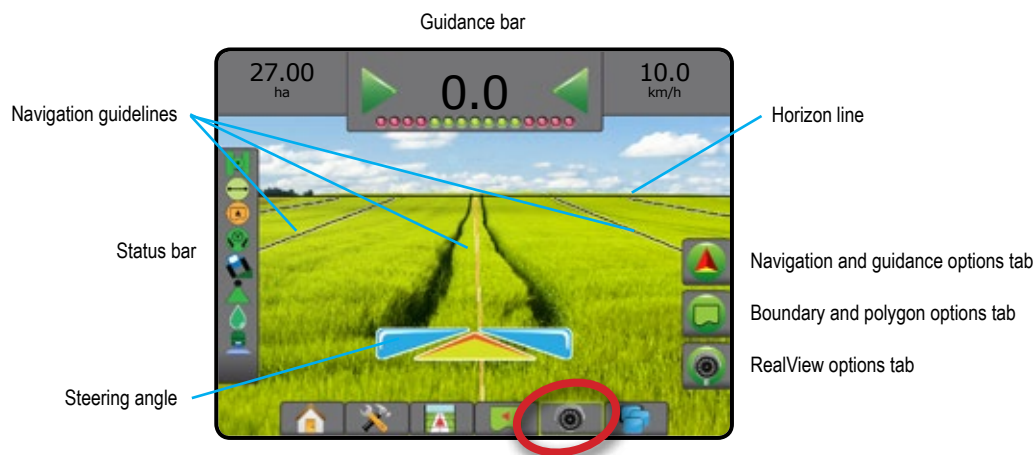







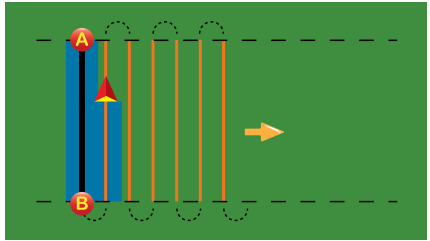

On screen guidance

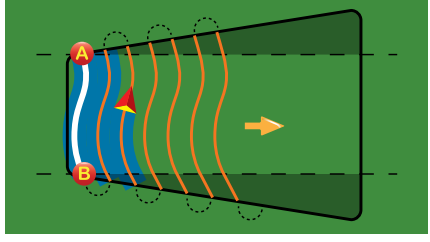
- Guidelines
 - ◀ Orange – active guidance line
 - ◀ Black (multiple) – adjacent guidance lines
 - ◀ Horizontal black line – adjustable horizon line
 - ◀ Black – exterior boundary line
 - ◀ Grey – interior boundary line
 - ◀ Blue – polygon boundary line

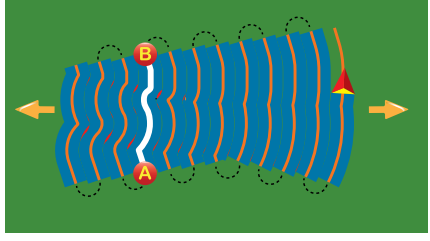

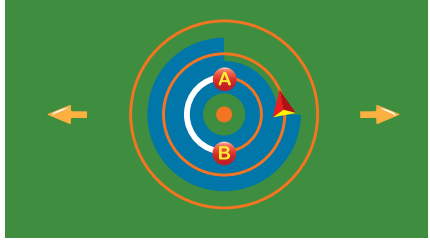
GUIDANCE MODES

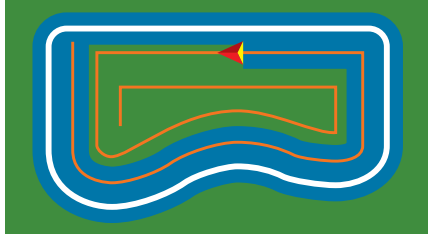
	<p>Straight AB guidance</p> <p>Straight AB guidance provides straight-line guidance based on A and B reference points. The original A and B points are used to calculate all other parallel guidelines.</p> <p><i>NOTE: Offset to adjacent guidelines will be calculated using the guidance width: see "Configuration-> Mapping and guidance" in the System setup chapter.</i></p>	
	<p>Curved AB guidance</p> <p>Curved AB guidance provides guidance along curved lines based on an initial AB reference line. This initial baseline is used to calculate all other guidelines.</p> <p><i>NOTE: Curved guidance is recommended not to exceed 30° within the AB guideline.</i></p> <p><i>Offset to adjacent guidelines will be calculated using the guidance width: see "Configuration-> Mapping and guidance" in the System setup chapter.</i></p> <p><i>HINT: While working in a bounded area, the guidance pattern extending beyond the established AB points will be straight-line guidance.</i></p>	
	<p>Adaptive curve AB guidance</p> <p>Adaptive curve guidance* provides guidance along a curved line based on an initial AB reference line where each adjacent guideline is drawn from the projected guidance width and heading.</p> <p><i>NOTE: Offset to adjacent guidelines will be calculated using the guidance width: see "Configuration-> Mapping and guidance" in the System setup chapter.</i></p>	
	<p>Circle pivot guidance</p> <p>Circle pivot guidance provides guidance around a central location that radiates inward or outward based on an initial AB reference line. This initial baseline is used to calculate all other guidelines.</p> <p>It is used for product application in a centre pivot field while being guided along a circular guideline that matches a centre pivot irrigation system radius.</p> <p><i>NOTE: Offset to adjacent guidelines will be calculated using the guidance width: see "Configuration-> Mapping and guidance" in the System setup chapter.</i></p>	
	<p>Last pass guidance</p> <p>Last pass guidance* offers true last-pass navigation. The console will automatically detect the nearest applied area and establish parallel guidelines based on that area.</p> <p><i>NOTE: If a boundary is established but no application occurred during the boundary process, guidance will not initiate.</i></p>	



NextRow guidance

NextRow guidance* indicates where the NextRow is located, and provides guidance at row ends to the next adjacent row. When the operator marks the end of the row and begins turning to the next row, a Straight AB guidance line is provided in the next row. When the vehicle is in the NextRow, guidance is turned off.

*NOTE: Offset to NextRow will be calculated using the guidance width: see "Configuration-> Mapping and guidance" in the System setup chapter.
The NextRow Guidance does not support skipping rows.*

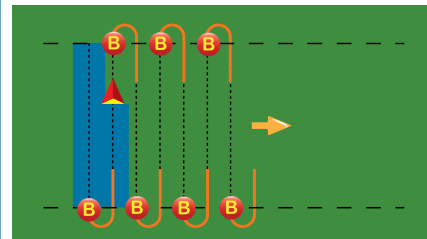

No guidance

No guidance* turns off guidance.

NOTE: No guidance mode does not delete established guide lines or points from the console. To delete established/saved data from the console, see "Data management" in the System setup chapter.

*Guidance options may not be available depending on assisted/automatic steering system installed.

Adjacent rows may be skipped in Straight AB guidance, Curved AB guidance, Adaptive curve guidance and Circle pivot guidance. Last pass guidance and NextRow guidance do not support skipping adjacent rows.

GUIDELINES

AB guidelines, Azimuth guidelines, next pass guidelines, and NextRow guidelines are each available depending on the current guidance mode. Switching from one guidance mode to another will change the current available guidelines.

Multiple guidelines can be created in each guidance mode. If more than one guideline is saved in a single guidance mode, the Next Guideline feature will become available. By pressing the Next guideline option, the vehicle will be directed to the next guideline saved in the console.

A user can duplicate and edit jobs for reuse of guidelines, boundaries, applied data, prescription map and/or polygons for different applications over the same field using Fieldware Link or the Data -> Job data -> Manage option.

Marking A and B points

To establish an AB guideline:

1. Drive to the desired location of Point A .
2. Press NAVIGATION AND GUIDANCE OPTIONS tab to display navigation options.
3. Press MARK A icon .
4. Drive to the desired location of Point B .
5. Press MARK B icon to establish the AB line.
6. "Would you like to name this guideline?"

Press:

- ▶ Yes – to enter a name and save the guideline in the console
- ▶ No – to automatically generate a name and save the guideline in the console

The console will begin providing navigation information.

NOTE: The MARK B Icon is not available for selection (greyed out) until the minimum distance is travelled (3.0 metres in Straight, Curved or Adaptive curve guidance; 50.0 metres in Circle pivot guidance).

NOTE: It is not necessary to drive the entire circumference of the centre pivot in order to initiate Circle pivot guidance.

Use CANCEL MARK icon to cancel the Mark A command and revert to the previous guideline (when established).

Figure 7-17: Mark A point



Figure 7-18: Mark B point



Figure 7-19: Save guideline



Figure 7-20: Follow guidance

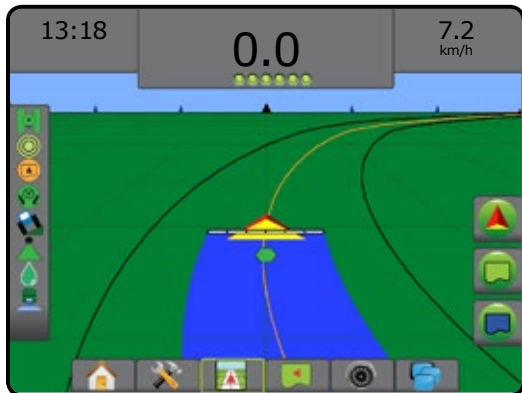

A+ nudge feature

A+ The A+ nudge feature allows the current guideline to be shifted to the vehicle's current location.

NOTE: Available only when in Straight AB or Curved AB guidance.

To adjust the guideline:







1. Press NAVIGATION AND GUIDANCE OPTIONS tab  to display navigation options.
2. Press A+ NUDGE icon .

Figure 7-21: A+ nudge



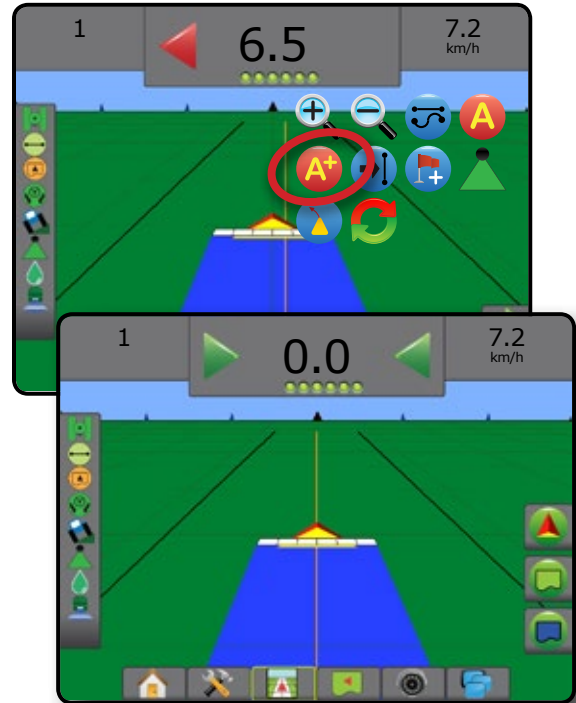



Next guideline feature

If more than one guideline is saved, the Next guideline feature will become available. By pressing the Next guideline option, the vehicle will be directed to the next guideline saved in the console.

- Next straight guideline  – shows the next straight AB or Azimuth degree guideline saved in the current job.
- Next curved AB guideline  – shows the next Curved AB guideline saved in the current job.
- Next circle pivot guideline  – shows the next Circle pivot AB guideline saved in the current job.
- Next adaptive curve guideline  – shows the next Adaptive Curve AB guideline saved in the current job.

NOTE: Offset to adjacent guidelines will be calculated using the guidance width. See “Configuration->Mapping and guidance” in the System setup chapter.

To change to other available guidelines:

1. Press NAVIGATION AND GUIDANCE OPTIONS tab  to display navigation options.
2. Press NEXT GUIDELINE icon    .





Toggle between all guidelines by pressing the NEXT GUIDELINE icon     again.

Figure 7-22: Next guideline



To view which guideline is active, press the Guidance mode icon on the Status bar.

Figure 7-23: View which guideline is active

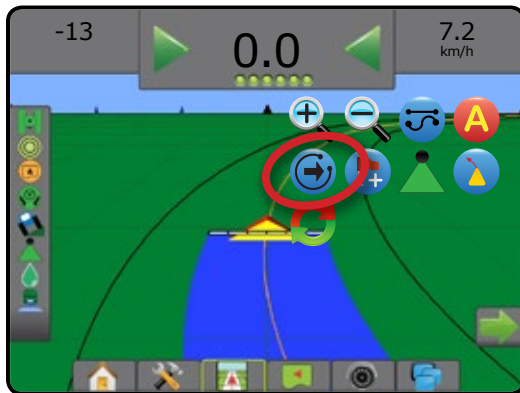

Last pass guidelines

 Last pass guidance offers true last-pass navigation. The console will automatically detect the nearest applied area and establish parallel guideline based on that area.

NOTE: Last pass guidance may not be available depending on assisted/automatic steering system installed.

To activate Last pass guidelines:

1. Drive to a desired location to apply the first pass.
2. Travel next to the applied area.
3. The console will begin providing navigation information.

NOTE: If a boundary is established but no application occurred during the boundary process, guidance will not initiate.

Figure 7-24: Apply first pass



Figure 7-25: Follow guidance

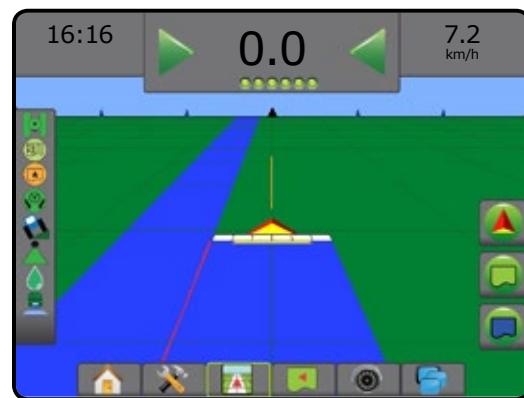



NextRow guidelines

 NextRow guidance indicates where the next row is located based on the programmed guidance width, and provides manual guidance information at user-marked row ends to the next adjacent row. When the operator signals the end of the row, a Straight AB line will be established in the current row and guidance provided to the NextRow. Once the vehicle has entered into the next row, no guidance or guidelines are shown.

NOTE: Offset to NextRow will be calculated using the guidance width: see "Configuration->Mapping and guidance" in the System setup chapter.

NOTE: NextRow guidance may not be available depending on assisted/automatic steering system installed.

To activate NextRow guidelines:

1. Press NAVIGATION AND GUIDANCE OPTIONS tab  to display navigation options.
2. At the end of a row (while driving a straight line) press MARK B icon .
 - ◀The end of the row will be marked with a green point .
3. Turn toward the next row.
4. Based on that direction turned, guidance will be provided for the next adjacent row.
 - ◀When the vehicle is in the row, the guideline is removed.
5. Repeat at the end of the next row.

NOTE: The NextRow guidance feature does not support skipping rows.

Figure 7-26: Mark end of row





Azimuth degree

 An azimuth is defined as a horizontal angle measured clockwise from a true north baseline. When using an azimuth, the point from which the azimuth originates is the centre of an imaginary circle. North = 0°, East = 90°, South = 180°, West = 270°.

Azimuth degree guidance projects a guideline between the current vehicle position (the A point) and a B point set 100 metres away along the entered azimuth heading.

To establish an Azimuth degree guideline:

1. Press NAVIGATION AND GUIDANCE OPTIONS tab  to display navigation options.
2. Press AZIMUTH icon  to enter azimuth degree.
3. Use the entry screen to establish the azimuth degree.
4. "Would you like to name this guideline?"

Press:

- ▶ Yes – to enter a name and save the guideline
- ▶ No – to automatically generate a name

The console will begin providing navigation information.

To establish additional azimuth guidelines, follow the same steps as the initial azimuth guideline.

Figure 7-27: Azimuth guidance



RETURN TO POINT

Return to point provides guidance back to an established point in Vehicle view and Field view. In Vehicle view an arrow directs the vehicle back to the established point. In Field view only the point is displayed.

A return point is job-specific, and will remain active in the active job until canceled.

NOTE: Return to point guidance may not be available depending on assisted/automatic steering system installed.

Marking a return point

To mark a return point:





1. Drive to the desired location of return point .
2. Press NAVIGATION AND GUIDANCE OPTIONS tab  to display navigation options.
3. Press ADD POINT icon .

Figure 7-28: Return point established – Vehicle view

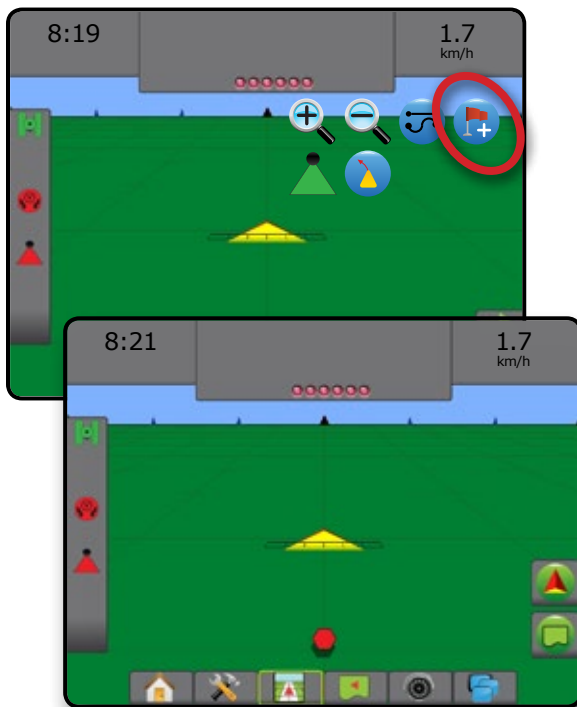

Delete the return point

To delete the established return point:

1. Press NAVIGATION AND GUIDANCE OPTIONS tab  to display navigation options.
2. Press DELETE POINT icon .



Delete Point icon is not available while return to point guidance is active.

Figure 7-29: Delete point



Guidance to a return point

To show distance and guidance to the established return point:

1. Press NAVIGATION AND GUIDANCE OPTIONS tab  to display navigation options.
2. Press the RETURN TO POINT GUIDANCE icon .

The console will begin providing the distance information on the Guidance bar from the vehicle to the established point.

Use CANCEL RETURN TO POINT GUIDANCE icon  to hide distance and guidance to the established point.

Guidance cannot be calculated when “?” appears in the guidance bar.

Figure 7-30: Return to point guidance – Vehicle view

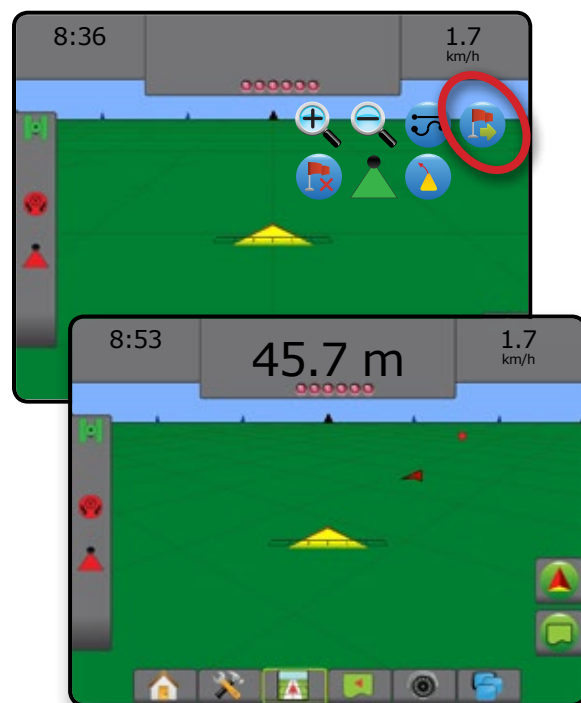

BOOMPILOT

Depending on if there is a section control system present and when present what kind of section control is being used as well as what options are enabled, there are multiple options for BoomPilot section control.

This section includes setup options for these configurations:

- ▶ No Section control module
 - Console only
 - With optional work on/off switch
- ▶ ISOBUS sprayer
 - Console and ECU only
 - With switchbox
 - With an ISOBUS implement status module (ISO ISM)
- ▶ ISOBUS spreader
 - Console only
 - With optional spreader on/off switch
- ▶ With TeeJet Section control module and switchbox or ISM
- ▶ With TeeJet Section control module

Figure 7-31: BoomPilot icon and Status bar indicator



No Section control module

If a section control system is not present, the BoomPilot icon or an optional work on/off switch is used to turn the single section on or off. Only one section width will be illustrated and the status bar will have no icon.



NOTE: If an ISOBUS controller, SmartCable, Section driver module (SDM), or Switch function module (SFM) is present, please refer to the following sections for more information.

NOTE: The BOOMPILOT icon is grey  when GNSS is unavailable.

Console only



The BoomPilot icon is used to turn the section on or off.

To set configuration settings:



1. Press SYSTEM SETUP bottom tab .
2. Press CONFIGURATION side tab .
3. Press **Implement**.
4. Set "BoomPilot icon" to **Enable**.

NOTE: BoomPilot start mode setting will make no difference in the function of this option.

To switch application off or on using the console:

1. Press NAVIGATION AND GUIDANCE OPTIONS tab  to display navigation options.
2. Press BOOMPILOT icon .
3. Press BOOMPILOT icon  to toggle the section on or off.

ISOBUS sprayer



If an ISOBUS electronic control unit (ECU) is present, the BoomPilot icon or an optional switchbox can be used to turn the boom on or off. The BoomPilot icon may also be used to set automatic section control to manual  or automatic . The number of section widths displayed will depend on the ISOBUS ECU configuration.

NOTE: The BOOMPILOT icon is grey  when GNSS is unavailable.

Console and ECU only



All ISOBUS rate control configurations should be setup before starting BoomPilot. Automatic or manual regulation mode should not affect the following options.

To set configuration settings:

1. Press SYSTEM SETUP bottom tab .
2. Press CONFIGURATION side tab .
3. Press **Implement**.
4. Set "BoomPilot icon" to **Enable**.





NOTE: BoomPilot start mode setting will make no difference in the function of this option.

To switch application off or on automatically:

1. Press NAVIGATION AND GUIDANCE OPTIONS tab  to display navigation options.
2. Press BOOMPILOT icon .
◀Automatic – status bar icon will change to green .

NOTE: Application can be manually controlled while in Automatic BoomPilot mode using the Start/stop key on the ISOBUS Operation screen.



To switch application off or on manually:

1. Press NAVIGATION AND GUIDANCE OPTIONS tab  to display navigation options.
2. Press BOOMPILOT icon .
◀Automatic – status bar icon will change to red .
3. Press ISOBUS UNIVERSAL TERMINAL bottom tab .
4. Go to the Operation screen
5. Use the START/STOP key .

With switchbox



All ISOBUS rate control configurations should be setup before starting BoomPilot. Automatic or manual regulation mode should not affect the following options.

To set configuration settings:

1. Press SYSTEM SETUP bottom tab .
2. Press CONFIGURATION side tab .
3. Press **Implement**.
4. Set "BoomPilot icon" to **Disable**.

NOTE: BoomPilot start mode setting will make no difference in the function of this option.



To switch application off or on automatically:

1. Switchbox master switch and section switches must be in the "On" positions.
1. Press NAVIGATION AND GUIDANCE OPTIONS tab  to display navigation options.
2. Press BOOMPILOT icon .
◀Automatic – status bar icon will change to green .

NOTE: Application can be manually controlled while in Automatic BoomPilot mode using the master switch or individual section switches.

Caution: With some versions of ISOBUS software, while in a previously applied area, manually changing a section switch will change BoomPilot to manual mode. Therefore, if a switch remained in the on position after exiting the applied area, it would remain off.



To switch application off or on manually:

1. Press NAVIGATION AND GUIDANCE OPTIONS tab  to display navigation options.
2. Press BOOMPILOT icon .
◀Manual – status bar icon will change to red .
3. Turn master switch or individual section switches On/Off.

With an ISOBUS implement status module (ISO ISM)



All ISOBUS rate control configurations should be setup before starting BoomPilot. Regulation mode should be "Manual".

To set configuration settings:

1. Press SYSTEM SETUP bottom tab .
2. Press CONFIGURATION side tab .
3. Press **Implement**.
4. Set "BoomPilot icon" to **Enable**.



NOTE: BoomPilot start mode setting will make no difference in the function of this option.

To switch application off or on automatically:



1. Press NAVIGATION AND GUIDANCE OPTIONS tab  to display navigation options.
2. Press BOOMPILOT icon .
 - ◀Automatic – status bar icon will change to green 

NOTE: Application can be manually controlled while in Automatic BoomPilot mode using the switches connected to the ISO ISM.

To switch application off or on manually:

1. Press NAVIGATION AND GUIDANCE OPTIONS tab  to display navigation options.
2. Press BOOMPILOT icon .
 - ◀Automatic – status bar icon will change to red 
3. Turn master switch or individual section switches On/Off.

ISOBUS spreader



If an ISOBUS electronic control unit (ECU) is present, the BoomPilot icon or an optional remote master switch can be used to turn the application on or off. The BoomPilot icon may also be used to set automatic section control to manual  or automatic .

NOTE: The BOOMPILOT icon is grey  when GNSS is unavailable.

Console only





All ISOBUS rate control configurations should be setup before starting BoomPilot. Regulation mode should be "Manual".

To set configuration settings:

1. Press SYSTEM SETUP bottom tab .
2. Press CONFIGURATION side tab .
3. Press **Implement**.
4. Set "BoomPilot icon" to **Enable**.





NOTE: BoomPilot start mode setting will make no difference in the function of this option.

To switch application off or on automatically:

1. Press NAVIGATION AND GUIDANCE OPTIONS tab  to display navigation options.
2. Press BOOMPILOT icon .
 - ◀Automatic – status bar icon will change to green 
3. Press the ISOBUS UNIVERSAL TERMINAL bottom tab .
4. Go to the Operation screen.
5. Use the START/STOP key .

NOTE: Application can be manually controlled while in Automatic BoomPilot mode using the Start/stop key on the ISOBUS Operation screen.



To switch application off or on manually:

1. Press NAVIGATION AND GUIDANCE OPTIONS tab  to display navigation options.
2. Press BOOMPILOT icon .
 - ◀Automatic – status bar icon will change to red 
3. Press ISOBUS UNIVERSAL TERMINAL bottom tab .
4. Go to the Operation screen
5. Use the START/STOP key .

With optional spreader on/off switch

All ISOBUS rate control configurations should be setup before starting BoomPilot. Automatic or manual regulation mode should not affect the following options.

To set configuration settings:

1. Press the ISOBUS UNIVERSAL TERMINAL bottom tab .
2. Enable the Remote spread switch.
3. Press SYSTEM SETUP bottom tab .
4. Press CONFIGURATION side tab .
5. Press **Implement**.
6. Set "BoomPilot icon" to **Disable**.

NOTE: BoomPilot start mode setting will make no difference in the function of this option.

In areas where application is desired:



1. Turn Spreader on/off switch to the "on" position.

In areas where application is not desired:

1. Turn Spreader on/off switch to the "off" position.

With TeeJet section control module and switchbox or ISM

SmartCable, Section driver module (SDM) or Switch function module (SFM) and a switchbox or Implement status module (ISM) is present.

NOTE: The BOOMPILOT icon is grey  when GNSS is unavailable. BoomPilot status bar icon will be off/manual .

To switch application off or on automatically:



1. Automatic/manual boom switch must be in the “Auto” position.
◀Automatic – status bar icon will be green 
2. Master switch and section switches must be in the “On” position.



NOTE: Application can be manually controlled while in Automatic BoomPilot mode using the switches on the switchbox or switches connected to the ISO ISM.

To switch application off or on manually:





1. Automatic/manual boom switch must be in the “Manual” position.
◀Manual – status bar icon will be red 
2. Use the switches on the switchbox or switches connected to the ISO ISM.

With TeeJet section control module



SmartCable, Section driver module (SDM) or Switch function module (SFM) is present BoomPilot is used to set automatic section control to off/manual , automatic , or spot application 

NOTE: The BOOMPILOT icon is grey  when GNSS is unavailable. BoomPilot status bar icon will be off/manual .

To switch application off or on automatically:

1. Press NAVIGATION AND GUIDANCE OPTIONS tab  to display navigation options.
2. Press and release BOOMPILOT icon 
◀Enable – status bar icon will change to green 
◀Disable – status bar icon will change to red 



To apply a spot application:

1. Press NAVIGATION AND GUIDANCE OPTIONS tab  to display navigation options.
2. Press and hold BOOMPILOT icon  over area to be applied.
◀Spot application– status bar icon will change to yellow 

CURVED LOOKAHEAD

The curved lookahead guideline provides an indication of where the current steering will take the vehicle using a ‘pointer’ as guidance. The Curved lookahead option is available in all guidance modes.

To activate the Curved lookahead guideline:



1. Press NAVIGATION AND GUIDANCE OPTIONS tab  to display navigation options.
2. Select CURVED LOOKAHEAD icon .

The pointer will be visible on the navigation screen.

Figure 7-32: Curved lookahead



To remove the Curved lookahead guideline:

1. Press NAVIGATION AND GUIDANCE OPTIONS tab  to display navigation options.
2. Select CURVED LOOKAHEAD icon .



REFRESH GNSS POSITION

Refresh GNSS position resets the ClearPath filter in the OEMStar receiver in cases where the user has had the receiver running in close proximity to heavy tree cover and/or buildings. See “Configuration-> GNSS receiver configuration” to activate the Refresh GNSS position icon.

NOTE: Activating the refresh while in a job will cause a momentary interruption in the relay of GNSS data. This will most likely result in sections already on in automatic BoomPilot mode to go off for a short period of time.

The refresh should not be done during active application.

To refresh the GNSS position:



1. Press NAVIGATION AND GUIDANCE OPTIONS tab  to display navigation options.
2. Select Refresh GNSS POSITION icon .

Figure 7-33: Refresh GNSS position



NOZZLE FAULT RESET

Nozzle fault reset clears any nozzle fault indications. See “Configuration-> Nozzle flow monitor” to adjust alarm configurations.

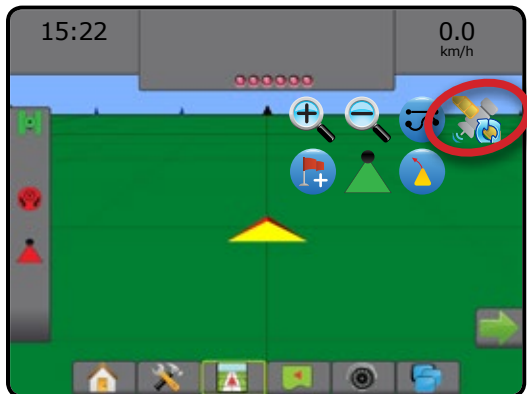
To reset the nozzle fault indications:



1. Press NAVIGATION AND GUIDANCE OPTIONS tab  to display navigation options.
2. Select NOZZLE FAULT RESET icon .

Figure 7-34: Nozzle Flow Monitor



BOUNDARIES AND POLYGONS

Available on any guidance screen, the Boundaries and polygons tab displays exterior boundary, interior boundary and polygon options.



Mapping location

Mapping location establishes the layout of the location from which the boundary or polygon will be mapped.

- ▶ Default location – While creating an exterior boundary or polygon, the line will be to the exterior of the outermost active section. While creating an interior boundary, the line will be to the interior of the innermost active section. If no sections are active, the boundary will be marked to the end of the outermost section.
- ▶ User entry – in-line and lateral offset from the GNSS antenna directions and distances can be specified by the user. Up to five (5) user entries can be created. See “Configuration-> Mapping and guidance-> Mapping location-> User Entered Mapping Location” for details.

Application is not required to map a boundary or polygon.



If mapping a boundary or polygon with one or more sections folded in and turned off, it is necessary to maintain this section configuration for the duration of the boundary or polygon pass. Any changes made to the number of sections turned on, and therefore the width of the machine after the boundary or polygon mapping process has started, will result in the application mapping the boundary or polygon at the outer edge of all the programmed sections – not necessarily those turned on at any given time during the boundary or polygon pass.

When mapping a boundary or polygon with some sections turned off, it is necessary to turn BoomPilot to Manual mode  and turn ON the master and section switches for all sections that will be used during the boundary or polygon pass. Once the boundary or polygon pass is complete the sections switches can be turned OFF, master switch remains ON, BoomPilot can be returned to Automatic mode  and automatic section control can then be used.

NOTE: If a boundary is mapped with some sections folded as described above, it may be necessary to use the A+ NUDGE icon  on the guideline over to the correct position for subsequent passes in the field.

Boundaries

Application boundaries establish the work areas where product is or is not applied while using ASC or BoomPilot.



- Exterior boundary  – establishes a work area where application will be applied while using ASC or BoomPilot.
- Interior boundary  – establishes a work area where application will NOT be applied while using ASC or BoomPilot.

Boundaries can be established in all guidance modes. Up to 100 total exterior boundary and/or interior boundaries can be stored within a single job. Application is not required to map a boundary.

Using Data -> Job data -> Manage or with Fieldware Link, a user can duplicate and edit jobs for reuse of boundaries for different applications over the same field.

Establishing an exterior or interior boundary









To establish an exterior or interior boundary:

1. Drive to a desired location at the perimeter of the application area and orientate the vehicle in association to the established mapping location. See “Configuration->Mapping and guidance->Mapping location” for details.
2. Press BOUNDARY AND POLYGON OPTIONS tab  to display boundary and polygon options.
3. Press MARK BOUNDARY icon  .
4. Verify that the Mapping location is correct.

◀ If the Mapping location is not correct, press **Cancel** then go to Configuration-> Mapping and guidance-> Mapping location.

5. Travel the perimeter of the application area.

While traveling, use as needed:

- ▶ Pause Boundary   – pauses the mark boundary process.
 - ▶ Resume Boundary   – resumes the mark boundary process.
 - ▶ Cancel Boundary   – cancels mark boundary process.
6. Finish the boundary:
 - ▶ Automatic close – travel to within one swath width of the starting point. The boundary will close automatically (the white guideline will turn black).
 - ▶ Manual close – press the FINISH BOUNDARY icon   to close the boundary with a straight line between the current location and the starting point.

NOTE: If the minimum distance is not travelled (five times the swath width), an error message will pop-up.

7. Press:
 - ▶ Save – to save the boundary
 - ▶ Delete – to delete the boundary

Figure 7-35: Exterior boundary

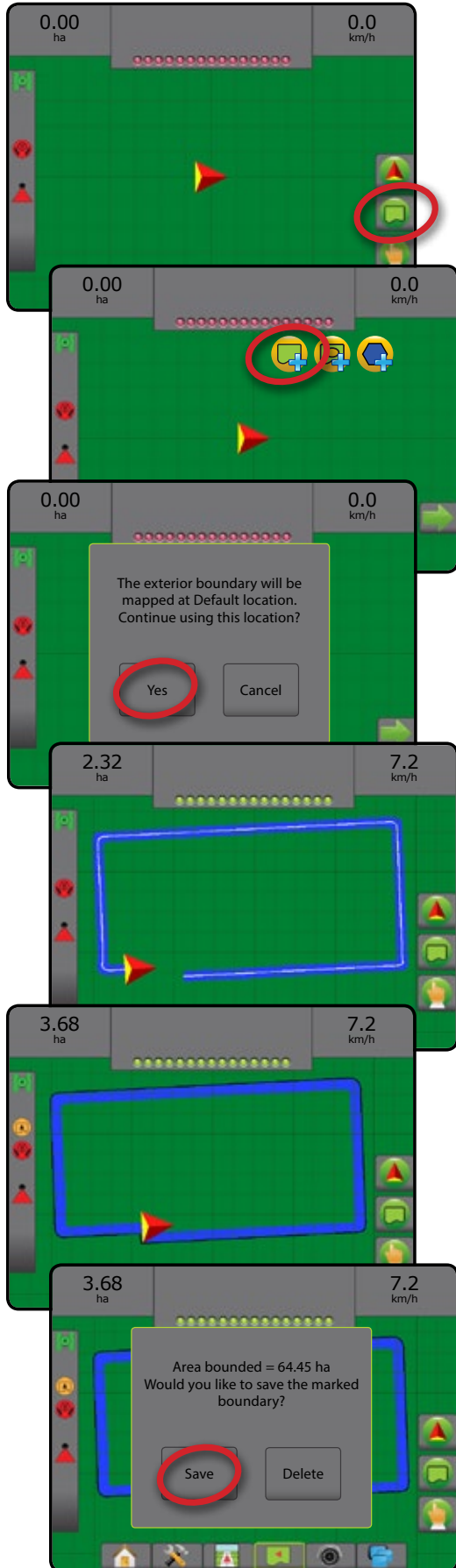
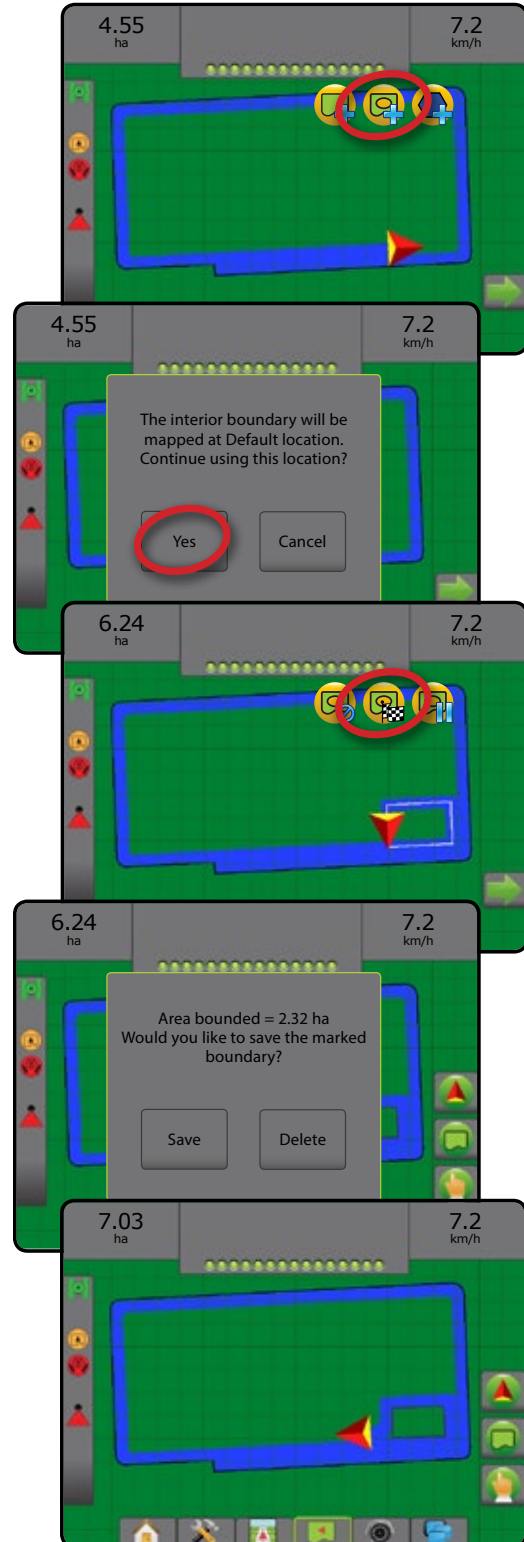

Figure 7-36: Add interior boundary



Delete last marked boundary



Use DELETE BOUNDARY icon  to delete the last marked boundary (interior or exterior) from the current job. Press again to remove additional boundaries in order from last to first created.

Figure 7-37: Delete last marked boundary

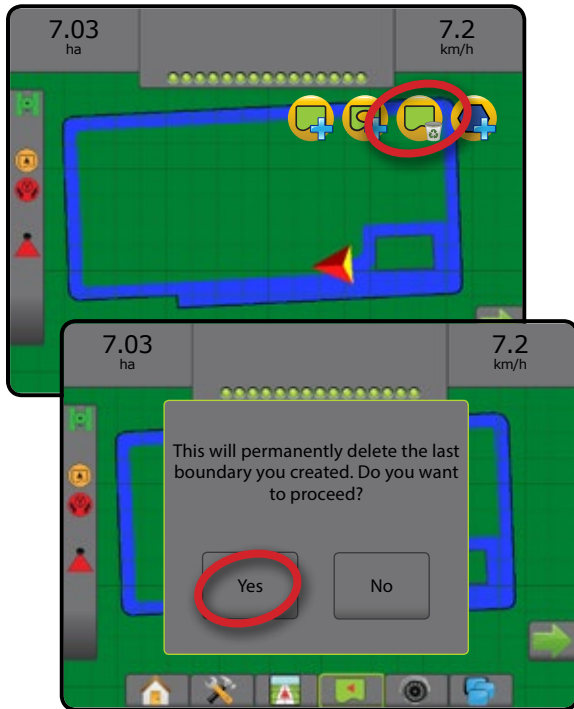

Boundary on status bar

In reference to your current location, the IN EXTERIOR BOUNDARY icon  or OUT OF EXTERIOR BOUNDARY icon  is displayed on the Status Bar once a boundary is established.



1. Press BOUNDED AREA icon  .
 - ◀ Working area – total are of all exterior boundaries
 - ◀ Field area – total area of all exterior boundries minus the area of all interior boundaries
 - ◀ Internal area – total area of all interior boundaries

Figure 7-38: Boundary on status bar



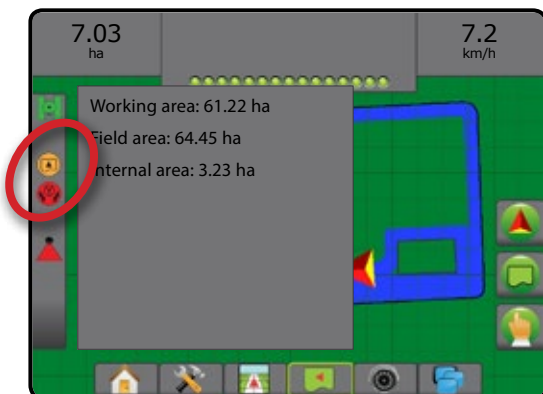

Polygons

Polygons establish mapping areas. Polygons can be established in all guidance modes. Up to 100 polygons can be stored within a single job. Application is not required to map a polygon.

Using Data -> Job data -> Manage or with Fieldware Link, a user can duplicate and edit jobs for reuse of polygons for different applications over the same field.

Establishing a polygon

To establish a polygon:

1. Drive to a desired location at the perimeter of the area and orientate the vehicle in association to the established mapping location. See "Configuration-> Mapping and guidance-> Mapping location" for details.
2. Press BOUNDARY AND POLYGON OPTIONS tab  to display boundary and polygon options.
3. Press MARK POLYGON icon .
4. Verify that the Mapping location is correct.
 - ◀ If the Mapping location is not correct, press **Cancel** then go to Configuration-> Mapping and guidance-> Mapping location.

5. Travel the perimeter of the area.

While traveling, use as needed:





- ▶ Pause polygon  – pauses the mark polygon process.
 - ▶ Resume polygon  – resumes the mark polygon process.
 - ▶ Cancel polygon  – cancels mark polygon process.
6. Press FINISH POLYGON icon  to finalize current mark polygon process. A straight line will complete the polygon between your current location and the starting point.
 7. Press:
 - ▶ Save and name – to save the polygon with a customized name. Names previously established will be available from a drop down list .
 - ▶ Save without naming – to save the polygon without naming
 - ▶ Discard – to delete the polygon

Figure 7-39: Polygon



Delete last marked polygon

Use DELETE POLYGON icon  to delete the last marked polygon from the current job. Press again to remove additional polygons in order from last to first created.

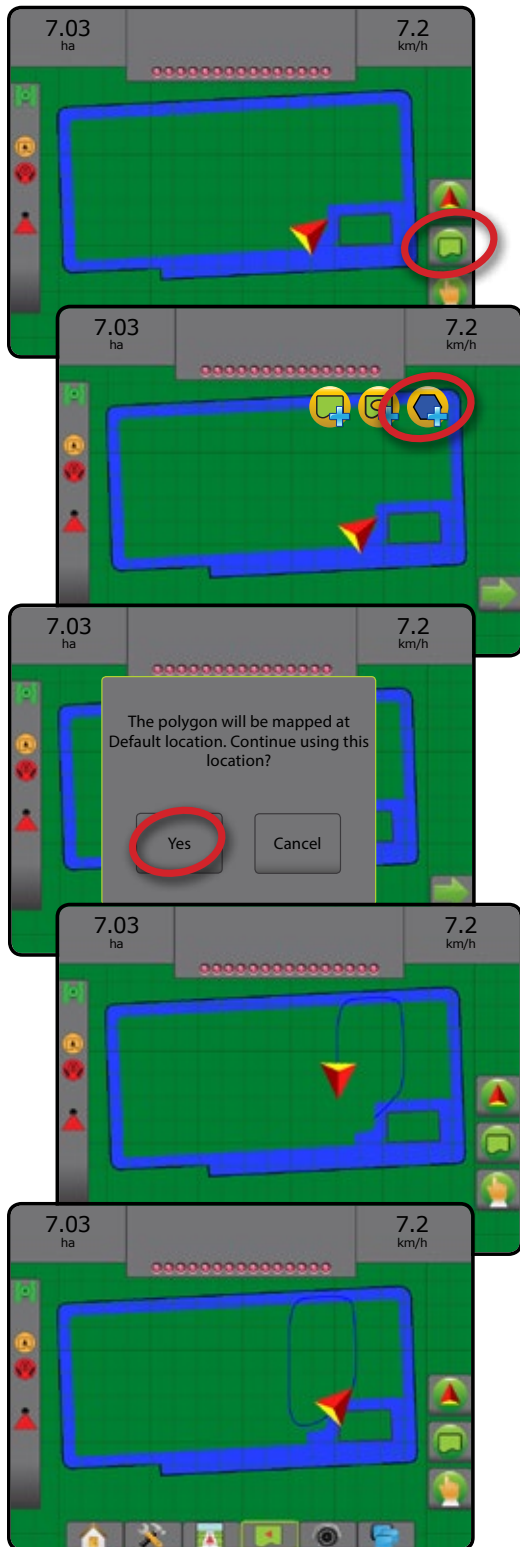
Figure 7-40: Delete last marked polygon





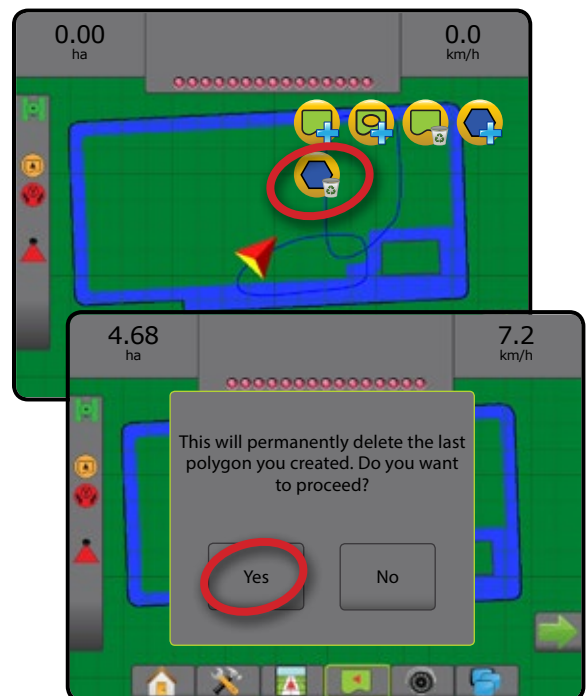

MAPPING OPTIONS

On vehicle view or field view guidance screens, in any guidance mode, the mapping options tab displays options to display polygon maps, coverage maps and application maps.

Polygon and coverage mapping are available when a polygon has been established.

GNSS-based product application mapping is available when a rate controller is on the system. Rate control mapping can record areas covered by the implement (Coverage) or how much product has been applied and where (Application), and can direct single- and variable-rate product application (Preset Target rate and Prescription, respectively).

- Coverage map  – shows areas covered by the implement, regardless of whether product was applied
- Polygons  – shows all mapped polygons
- Prescription map  – pre-loaded map that provides information to the rate controller for use in applying product
- Application map  – shows how much product has been applied and where, using colour to indicate level in proportion to preset or automatically set maximum and minimum levels
- Target rate map  – shows the application rate that the rate controller attempted to achieve at each location

NOTE: Before using mapping, set or verify product mapping options under Configuration->Product. Refer to “Product” in the System setup chapter. For more information on application mapping, see the Rate control chapter of this manual.

Polygon mapping

To access polygon mapping:









1. Press MAPPING OPTIONS tab  to display mapping options.
2. Select one or more:
 - ▶ Coverage map 
 - ▶ Polygons 

Figure 7-41: Coverage map with polygons

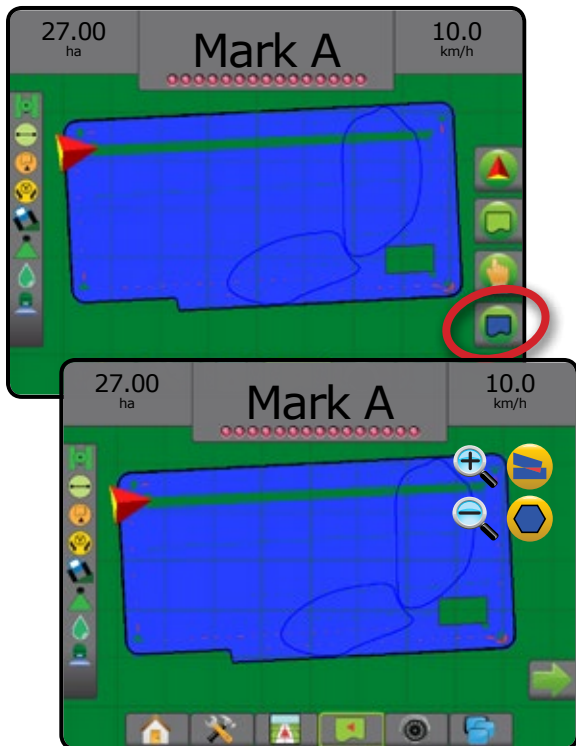

Rate control mapping

To access rate control mapping:

1. Press MAPPING OPTIONS tab  to display mapping options.
2. Select one or more:
 - ▶ Coverage map 
 - ▶ Prescription map 
 - ▶ Application map 
 - ▶ Target rate map 

NOTE: Application map and Target rate map cannot be selected simultaneously.

Figure 7-42: Coverage map with target rate mapping

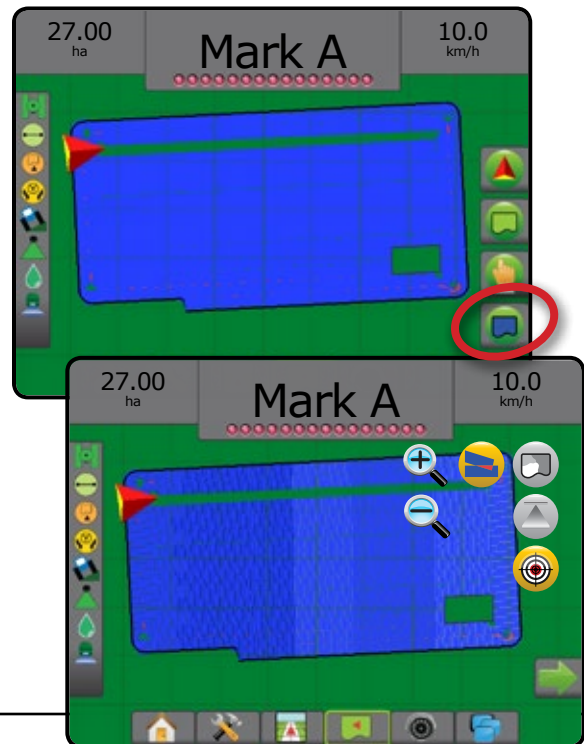

APPLICATION CONTROL OPTIONS

On vehicle view guidance screen, Application control options displays ISOBUS Sprayer application options.

NOTE: Options are available only when a ISOBUS Sprayer rate controller is on the system.

Target rate percentage increase/decrease icons increase/decrease the application target rate per the established percentage set in the Machine operation setup screen under Application rate step. Automatic regulation mode will automatically adjust the application rate based on the current speed in reference to the target rate.

NOTE: The Target rate percentage increase/decrease icons do the same adjustment as the Boost/step percentage increase/decrease keys from the ISOBUS UT.

To access the ISOBUS Sprayer application options:







1. Press APPLICATION CONTROL OPTIONS tab  to display application control options.
2. Select from:
 - ▶ Target rate percentage increase  – establishes the required boost percentage step increase
 - ▶ Target rate percentage decrease  – establishes the required boost percentage step decrease
 - ▶ Percentage boost and reset    – shows current boost percentage step and when pressed, zeros the boost percentage step

Figure 7-43: Application control options



ZOOM IN/OUT

Vehicle view

Zoom in/out & perspective is used to adjust the vehicle's view or perspective to the horizon from vehicle view to bird's-eye view.





- Zoom in  will adjust view to vehicle view displaying a compass on the horizon
- Zoom out  will adjust view to bird's-eye view

Figure 7-44: Zoom in to zoom out



Field view

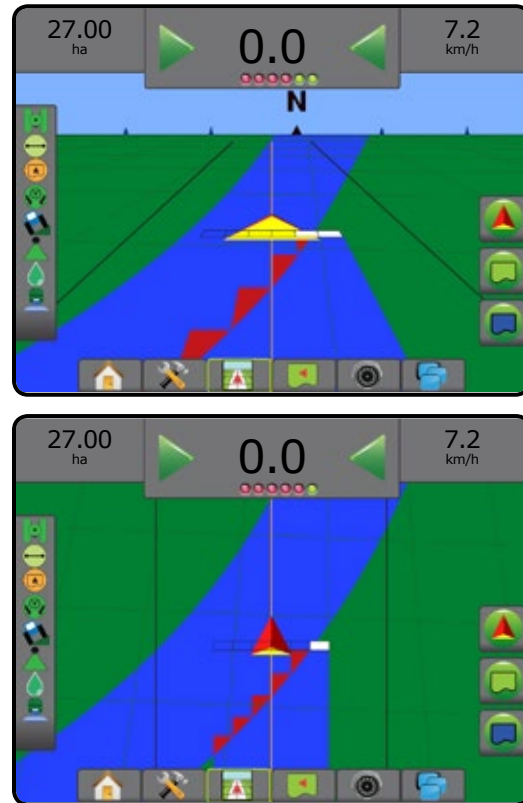





Zoom in/out is used to adjust the map's visible area.

- Zoom in  will decrease the amount of map area visible.
- Zoom out  will increase the amount of map area visible.

☞ PAN MODE

While in Field view guidance, the Pan mode allows the screen to be positioned manually as desired. The off-centre position on the screen will be retained until the World icon is pressed.

To enter Pan mode and pan across the screen:

1. Press SCREEN OPTIONS tab .
2. Press:
 - ▶ AND DRAG SCREEN in the corresponding direction to move the view on screen.
 - ▶ ARROWS     in the corresponding direction to move the view on screen (down, left, right, up).
 - ▶ WORLD VIEW icon  to centre vehicle on screen and extend the screen view to the widest area available.

NOTE: Press & hold ARROWS     to quickly adjust settings.

To close Pan mode options:

1. Press CLOSE OPTIONS tab .

Figure 7-45: Pan mode



📷 REALVIEW SPECIFIC OPTIONS

RealView guidance allows live video input to be displayed instead of a computer-generated image. RealView setup options accesses additional guidance tools including guidance over video and a steering angle indicator.

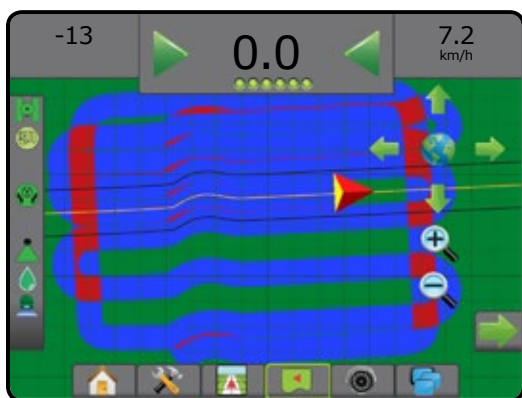
- ▶ Single camera – a single camera is directly attached to the console
- ▶ Video selection module – if a Video selection module (VSM) is installed on the system, two (2) video options are available:
 - One camera view – one of up to eight camera inputs can be selected to change the view of the video input.
 - Split camera view – one of two sets of four camera inputs (A/B/C/D or E/F/G/H) can be selected to divide the screen into four separate video feeds.

To adjust the camera view [reverse, upside down], go to Setup-> Configuration-> Video.

To access the RealView options:







1. Press REALVIEW GUIDANCE bottom tab .
2. Press REALVIEW OPTIONS tab  to display RealView options.
3. Select from:
 - ▶ Single camera view  [VSM only] – one (1) of up to eight (8) camera inputs can be selected to change the view of the video input
 - ▶ Split camera view  [VSM only] – one (1) of two (2) sets of four (4) camera inputs (A/B/C/D or E/F/G/H) can be selected to divide the screen into four separate video feeds
 - ▶ RealView guidance options  – accesses additional guidance tools including guidance over video and a steering angle indicator
 - ▶ RealView camera image capture  – saves a still photo of the current view on the screen to a USB drive

Figure 7-46: RealView guidance



RealView guidance options

 RealView setup options accesses additional guidance tools including guidance over video and a steering angle indicator.









1. Press REALVIEW OPTIONS tab  to display RealView options.
2. Press REALVIEW GUIDANCE OPTIONS icon .
3. Select from:
 - ▶ Guidance over video  – places three-dimensional guidelines over the video feed for navigation assistance
 - ▶ Steering angle indicator  – displays the direction in which the steering wheel needs to be adjusted
 - ▶ Horizon line adjustment   – adjusts the on-screen horizon line up or down

Figure 7-47: RealView setup options

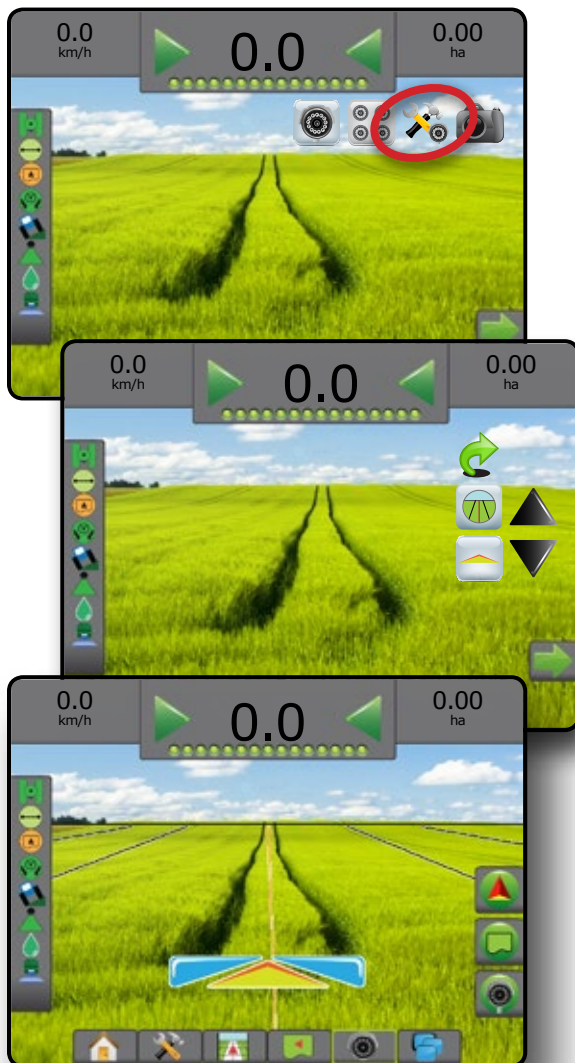

Camera snapshot

 RealView Camera Snapshot saves a still photo of the current view on the screen to a USB drive.







1. Insert USB drive.
2. Press REALVIEW OPTIONS tab  to display RealView options.
3. Press CAMERA SNAPSHOT icon .

Figure 7-48: RealView camera snapshot



VSM camera options

  If a Video selection module (VSM) is installed on the system, two (2) video options are available:

1. Press REALVIEW OPTIONS tab  to display RealView options.
2. Select from:
 - ▶ Single camera view  – one (1) of up to eight (8) camera inputs can be selected to change the view of the video input
 - ▶ Split camera view  – one (1) of two (2) sets of four (4) camera inputs (A/B/C/D or E/F/G/H) can be selected to divide the screen into four separate video feeds

Aeros 9040 field computer

- INTRODUCTION
- HOME
- FULL SCREEN
- SETUP
- GNSS
- IMPLEMENT
- GUIDANCE**
- RATE CONTROL
- APPENDIX

Figure 7-49: Single camera selection with VSM

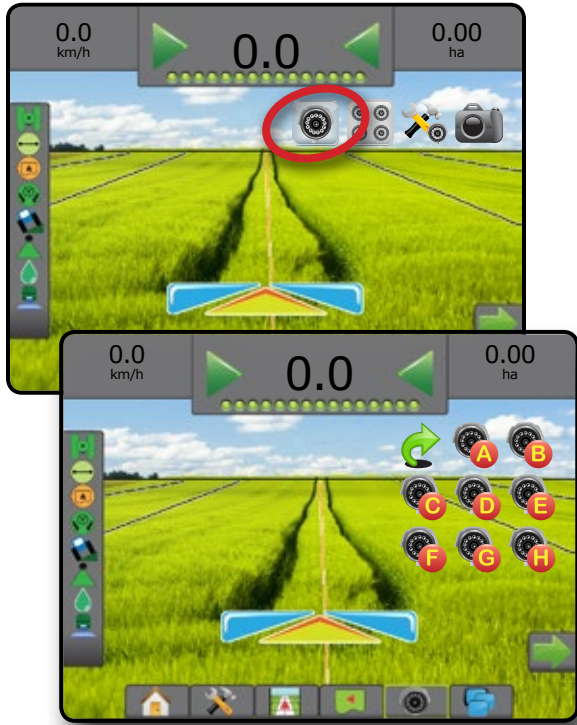
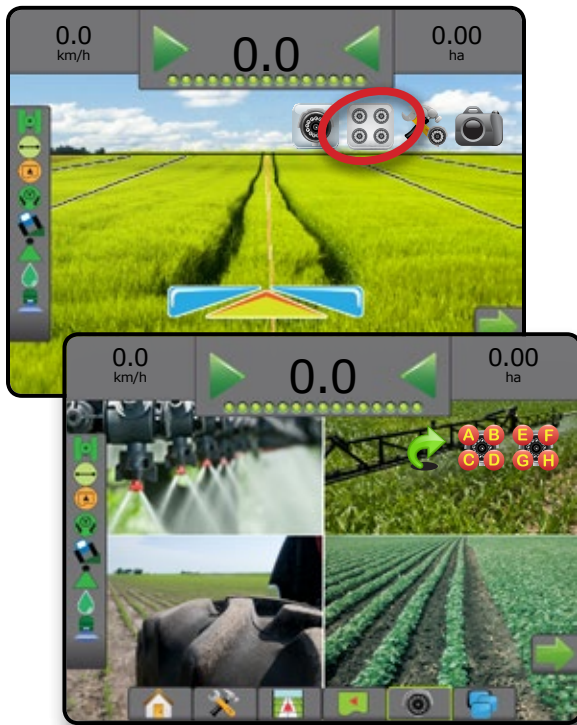

Figure 7-50: Select split view with VSM



CHAPTER 8 – RATE CONTROL

NOTE: TeeJet Dual Control Module (DCM) is no longer supported and will not be referenced in this manual.

ISOBUS universal terminal (UT) gives access to an ISOBUS electronic control unit (ECU) options and operation. This provides crop sprayer or spreader control when integrated into the implement of either capability.

- Easy navigation menu and data-rich display
- Provides basic or variable rate control
- Add additional ISOBUS ECUs as your needs change

NOTE: For detailed setup instructions, refer to the specific ISOBUS user manual for the connected ECU.

1. Press UNIVERSAL TERMINAL bottom tab .

Figure 8-1: Universal terminal overview

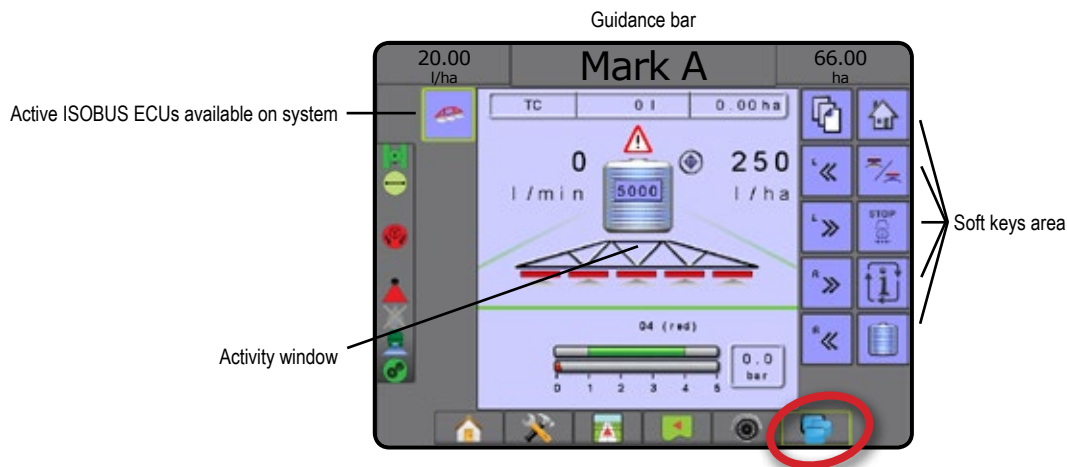

2. Press VEHICLE VIEW GUIDANCE tab .

Figure 8-2: Guidance screen options

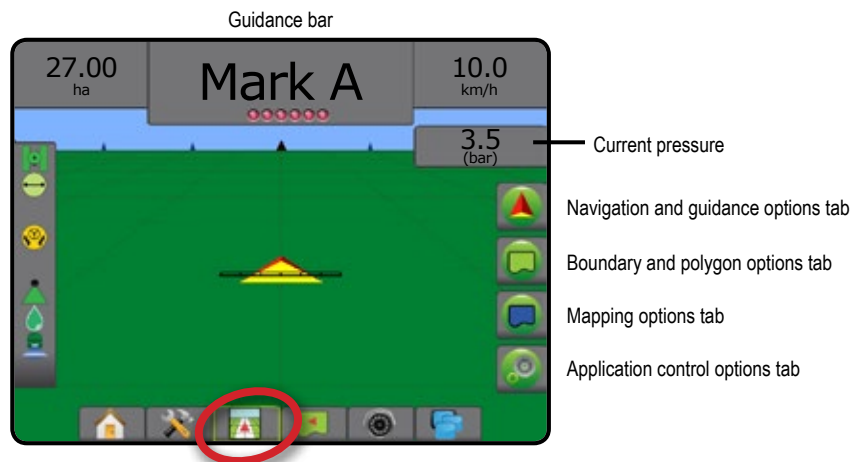

Aeros 9040 field computer

INTRODUCTION

HOME

FULL SCREEN

SETUP

GNSS

IMPLEMENT

GUIDANCE

RATE CONTROL

APPENDIX

Ready for operation

Upon starting up the system, an ISOBUS product may take a few minutes to load all required information or object pools.

Before starting a job, check to be sure the ISOBUS ECU is ready.

- Home screen is available
- Tack control (TC) is active – active trip count number should show “TC”

Figure 8-3: Ready for operation

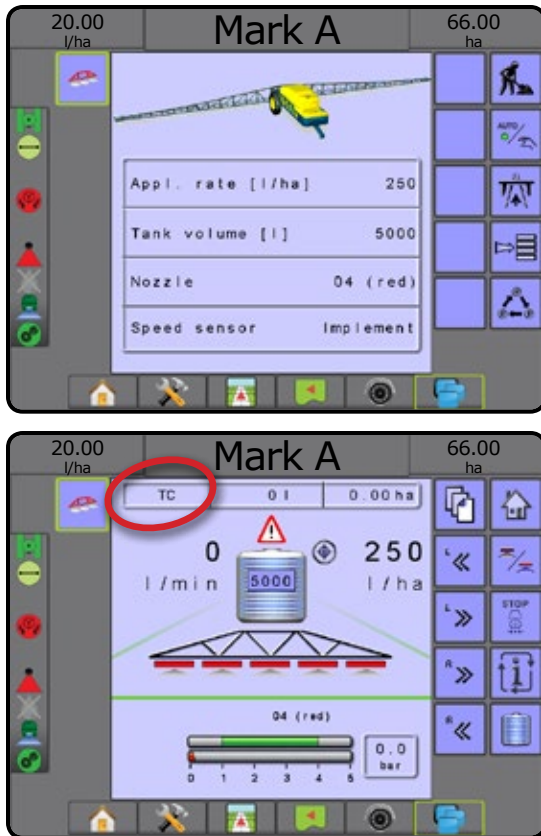

ISOBUS configuration options

When ISOBUS is in use, the ISOBUS page is used to select information for broadcast over the ISOBUS, and to verify specific information in troubleshooting.

1. Press SYSTEM SETUP bottom tab
2. Press CONFIGURATION side tab
3. Press **ISOBUS**.
4. Select from:
 - ▶ Machine speed broadcast – used to broadcast speed information provided by the machine over the ISOBUS
 - ▶ Navigation speed broadcast – used to broadcast speed information provided by the machine over the ISOBUS
 - ▶ Ground speed broadcast – used to establish if the GNSS speed shall be broadcast as Ground based speed on the ISOBUS from this console.

- ▶ Time/date broadcast – used to broadcast time and date over the ISOBUS

NOTE: Normally these shall be enabled, but if an alternative speed source shall be used, then it might be required to disable the GNSS speed, to ensure that the alternative speed source will be used by the ISOBUS controllers.

The following items on the ISOBUS page are for use **only** by TeeJet support technicians.

- ▶ Universal terminal (UT) Number [support technicians only] – used to define the unique number for this specific UT
 - ▶ Task controller (TC) Number [support technicians only] – used to define the unique number for this specific TC
 - ▶ Number of UT object pools [support technicians only] – shows the number of UT object pools are currently stored in the console
 - ▶ Number of ISOBUS control functions [support technicians only] – shows the number of ISOBUS control functions communicating on the ISOBUS
5. Press RETURN arrow or CONFIGURATION side tab to return to the main Configuration screen.

Figure 8-4: ISOBUS options

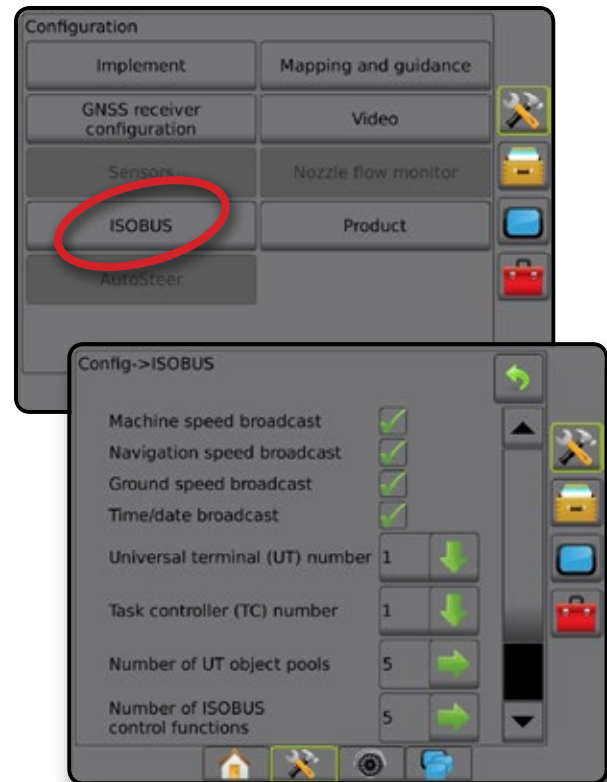



NAVIGATION SCREEN OPTIONS

When a ISOBUS electronic control unit (ECU) sprayer or spreader control is integrated into the implement, rate control options and mapping options are available on the Vehicle view and Field view guidance screens.

Guidance bar

In addition to the standard guidance bar options, the following selectable information will become available with an ISOBUS ECU:

- ▶ Actual application rate – displays the current application rate
- ▶ Target application rate – displays the target application rate
- ▶ Volume/product applied – displays the volume or weight of product applied
- ▶ Tank/bin amount remaining – displays the volume or weight of product remaining in the tank/bin

Figure 8-5: Guidance bar selectable information

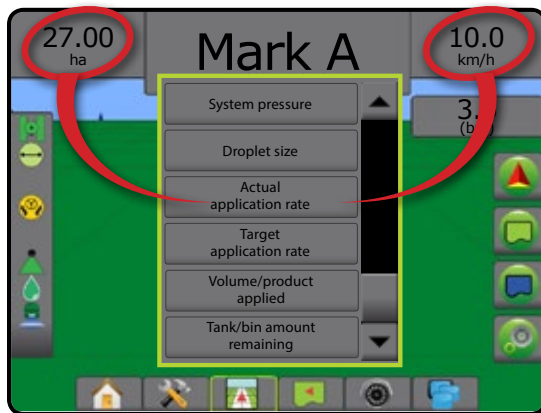

Current pressure

Displays the current pressure to the nozzle.

NOTE: The current pressure is also available on the ISOBUS Operation screen

Figure 8-6: Guidance screen options



Application control options

On vehicle view guidance screen, Application control options displays ISOBUS Sprayer application options.

Target rate percentage increase/decrease icons increase/decrease the application target rate per the established percentage set in the Machine operation setup screen under Application rate step. Automatic regulation mode will automatically adjust the application rate based on the current speed in reference to the target rate.

NOTE: The Target rate percentage increase/decrease icons do the same adjustment as the Boost/step percentage increase/decrease keys from the ISOBUS UT.

1. Press VEHICLE VIEW GUIDANCE bottom tab
2. Press APPLICATION CONTROL OPTIONS tab
3. Select from:
 - ▶ Target rate percentage increase – establishes the required boost percentage step increase
 - ▶ Target rate percentage decrease – establishes the required boost percentage step decrease
 - ▶ Percentage boost and reset – shows current boost percentage step and when pressed, zeros the boost percentage step









Figure 8-7: Application control options



Mapping options

On vehicle view or field view guidance screens, in any guidance mode, the mapping options tab displays options to display polygon maps, coverage maps and application maps.

NOTE: For more information, see “Application mapping” in this chapter of this manual.

1. Press VEHICLE VIEW GUIDANCE bottom tab  or FIELD VIEW GUIDANCE bottom tab .
2. Press MAPPING OPTIONS tab  to display mapping options.
3. Select one or more:
 - ▶ Coverage map 
 - ▶ Polygons 
 - ▶ Prescription map 
 - ▶ Application map 
 - ▶ Target rate map 

NOTE: Application map and Target rate map cannot be selected simultaneously.

Figure 8-8: Coverage, polygon and target rate maps

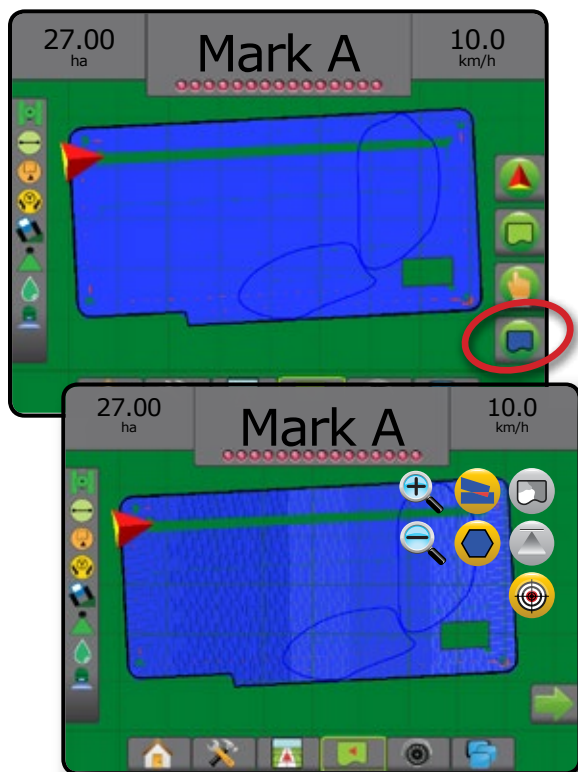

MAPPING OPTIONS

On vehicle view or field view guidance screens, in any guidance mode, the mapping options tab displays options to display polygon maps, coverage maps and application maps.

Polygon and coverage mapping are available when a polygon has been established.

GNSS-based product application mapping is available when a rate controller is on the system. Rate control mapping can record areas covered by the implement (Coverage) or how much product has been applied and where (Application), and can direct single- and variable-rate product application (Preset Target rate and Prescription, respectively).









NOTE: Before using mapping, set or verify product mapping options under Configuration->Product. Refer to “Product” in the System setup chapter.

Duplicating and transferring maps

Maps are stored in the job data. Using Data-> Job data, job data containing maps can be duplicated or transferred to Fieldware Link so the maps can be opened, viewed, edited, and printed, and transferred back to the console. See “Data management->Job data-> Transfer” and “Data management-> Job data-> Manage” in the System setup chapter for details.

Using Data-> Reports, reports in multiple formats can be generated that contain data and any maps from the job.

To access application mapping:

1. Press VEHICLE VIEW GUIDANCE bottom tab  or FIELD VIEW GUIDANCE bottom tab .
2. Press MAPPING OPTIONS tab  to display mapping options.
3. Select one or more:
 - ▶ Coverage map  – shows areas covered by the implement, regardless of whether product was applied
 - ▶ Polygons  – shows all mapped polygons
 - ▶ Prescription map  – pre-loaded map that provides information to the rate controller for use in applying product
 - ▶ Application map  – shows how much product has been applied and where, using colour to indicate level in proportion to preset or automatically set maximum and minimum levels
 - ▶ Target rate map  – shows the application rate that the rate controller attempted to achieve at each location

NOTE: Application Map and Target rate map cannot be selected simultaneously.

Figure 8-9: Coverage, polygon and target rate maps

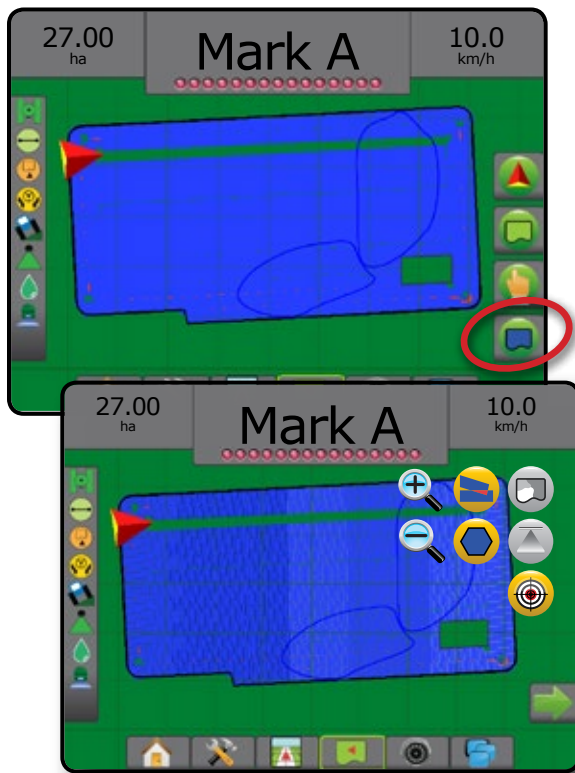

Coverage map

 Coverage map showing areas covered by the implement. ISOBUS requires product to be applied.

On screen mapping

- Coverage area – illustrates applied area and overlap:
 - ◀ Blue – one application
 - ◀ Red – two or more applications

Figure 8-10: Coverage map

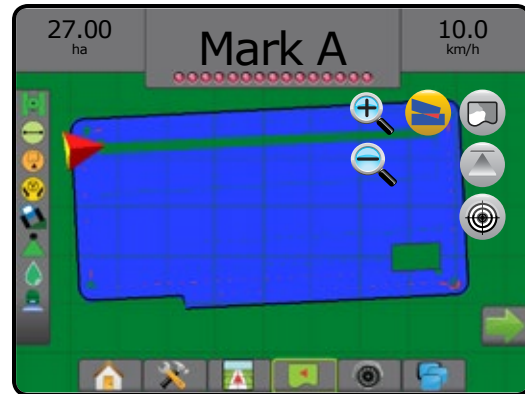

Polygons map

 Polygon map shows all mapped polygons.

On screen mapping

- Guidelines
 - ◀ Blue – polygon boundary line

Figure 8-11: Polygon map with rate control available

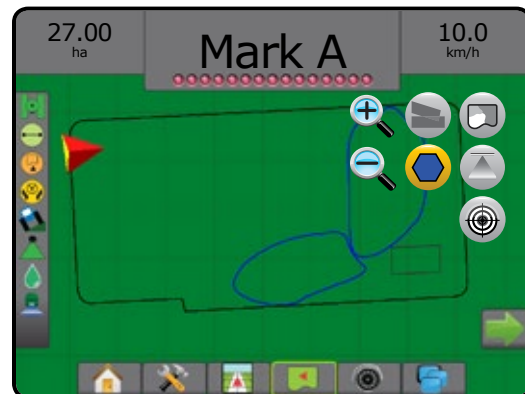

Prescription map

Prescription map is a pre-loaded map that provides information to the rate controller for use in applying product. Prescription maps contain geo-referenced product rate information. The Aeros 9040 can import job data containing Prescription maps for use with variable-rate application (VRA) using compatible rate controllers.

On screen mapping

- Zone lines:
 - ◀ Black when approaching the application zone.
 - ◀ White when within the application zone.
 - ◀ Other zones having the same rate will also be shown in white.
- Coverage area – illustrates different prescription rate zones:
 - ◀ User selected – zone colours are selected when establishing the prescription map.

With Fieldware Link (v5.01 or later), users can import VRA jobs created in Fieldware Link, as well as export job data from the console, edit the included maps to create Target rate or Prescription maps, and transfer back to the console for job use.

NOTE: Advanced job mode is required for variable rate applications. See Options (Job mode) in the System setup chapter.

Figure 8-12: Prescription map

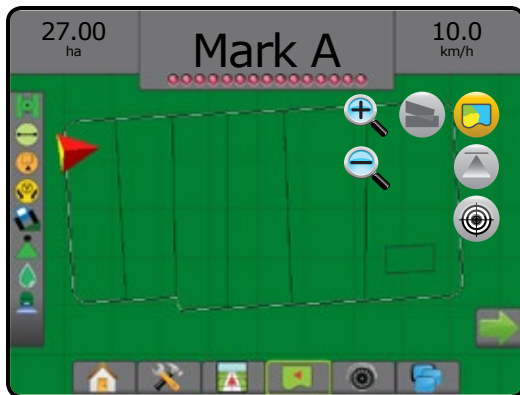

Application and target rate maps

Application map shows how much product has been applied and where, using colour to indicate level in proportion to preset or automatically set maximum and minimum levels

Target rate map shows the application rate that the rate controller attempted to achieve at each location

NOTE: Application map and Target rate map cannot be selected simultaneously.

Application map

Application map shows how much product has been applied and where, using colour to indicate level in proportion to preset or automatically set maximum and minimum levels.

NOTE: Application map and Target rate map cannot be selected simultaneously.

On screen mapping

- Coverage area – illustrates applied area:
 - ◀ User selected – applied areas show colored bars relative to selected colour range and map selection.

Figure 8-13: Application map

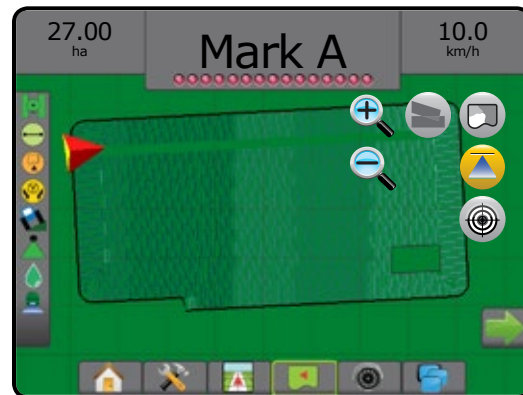

Target rate map

 Target rate map shows the target application rate that the rate controller attempted to achieve at each location.

NOTE: Application map and Target rate map cannot be selected simultaneously.

On screen mapping

- Coverage area – illustrates applied area:
 - ◀ User selected – applied areas show colored bars relative to selected colour range and map selection.

Figure 8-14: Target rate map

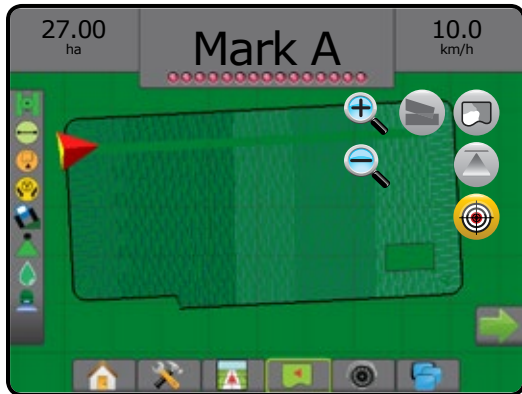

Target rates

Preset target application rates define target rates of product being applied per hectare/acre. These settings will set the same for all active jobs.

Target rates are established on the ISOBUS ECU using the ISOBUS UT. The current Target rate is selected and boosted using the ISOBUS Operation screen on the UT. Boosting can also be controlled using the Vehicle view screen

- Up to five (5) target rates can be established

Colour range selection

Product options configure maximum/minimum rate limits and corresponding display colours for mapping.



- Press SYSTEM SETUP bottom tab .
- Press CONFIGURATION side tab .
- Press **Product**.
- Select:
 - ▶ Color range – mode used to set the rate for Maximum rate colour and Minimum rate colour.
 - ◀ Automatic – maximum and minimum will be determined by actual applied rate values or target rate values
 - ◀ Manual – maximum and minimum limits will be set to those set in Applied rate mapping upper limit and Applied rate mapping lower limit options
 - ▶ Maximum rate colour – used to set the colour for the maximum rate. When in Manual colour range mode, this colour will be used for all rates above the Applied Rate mapping upper limit
 - ▶ Minimum rate colour – used to set the colour for the minimum rate. When in Manual colour range mode, this colour will be used for all rates below the Applied rate mapping lower limit

Figure 8-15: Product options



APPENDIX A – SYSTEM CONFIGURATIONS

The following diagrams are reflective of typical Aeros configurations. Due to the variety of possible configurations, this should be used for reference purposes only.

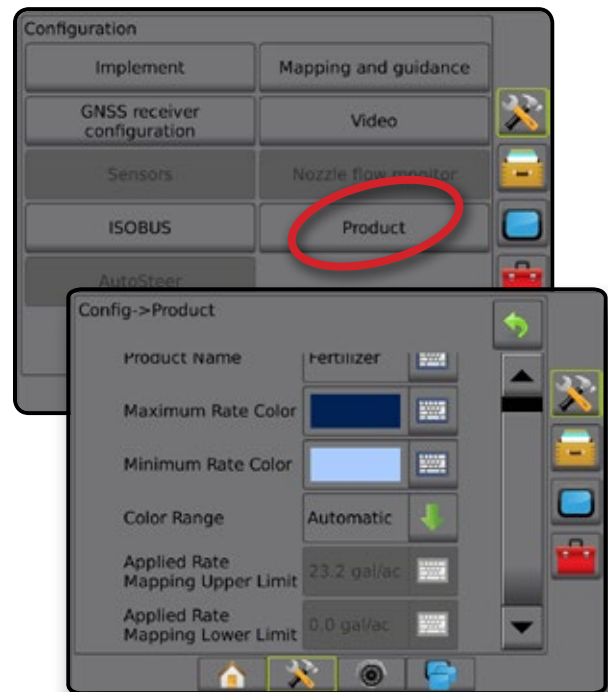
Figure A-1: Aeros IC18 Sprayer with FieldPilot AutoSteering System

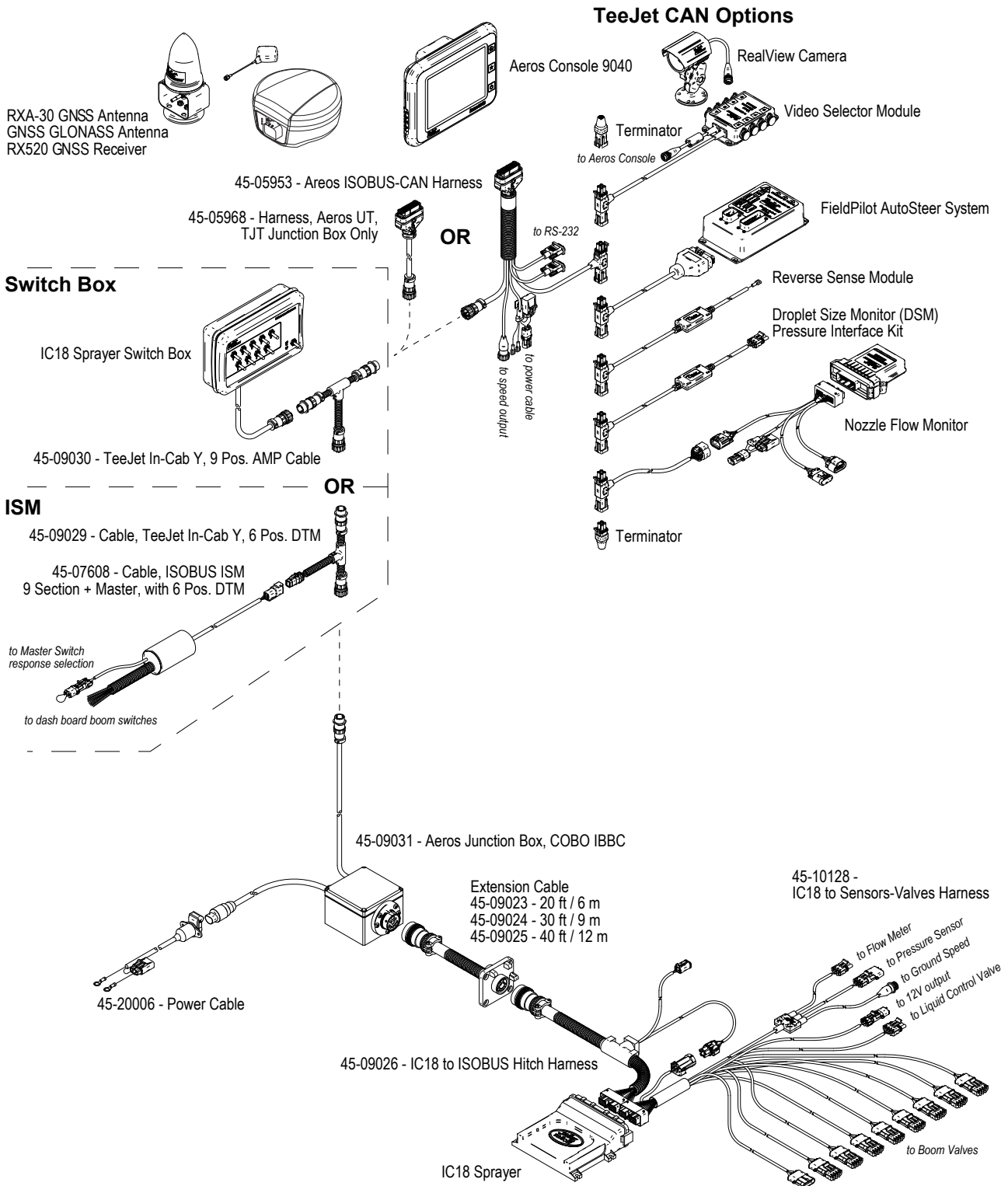

Aeros 9040 field computer

Figure A-2: Aeros IC18 sprayer with FieldPilot Pro or UniPilot Pro steering system

INTRODUCTION

HOME

FULL SCREEN

SETUP

GNSS

IMPLEMENT

GUIDANCE

RATE CONTROL

APPENDIX

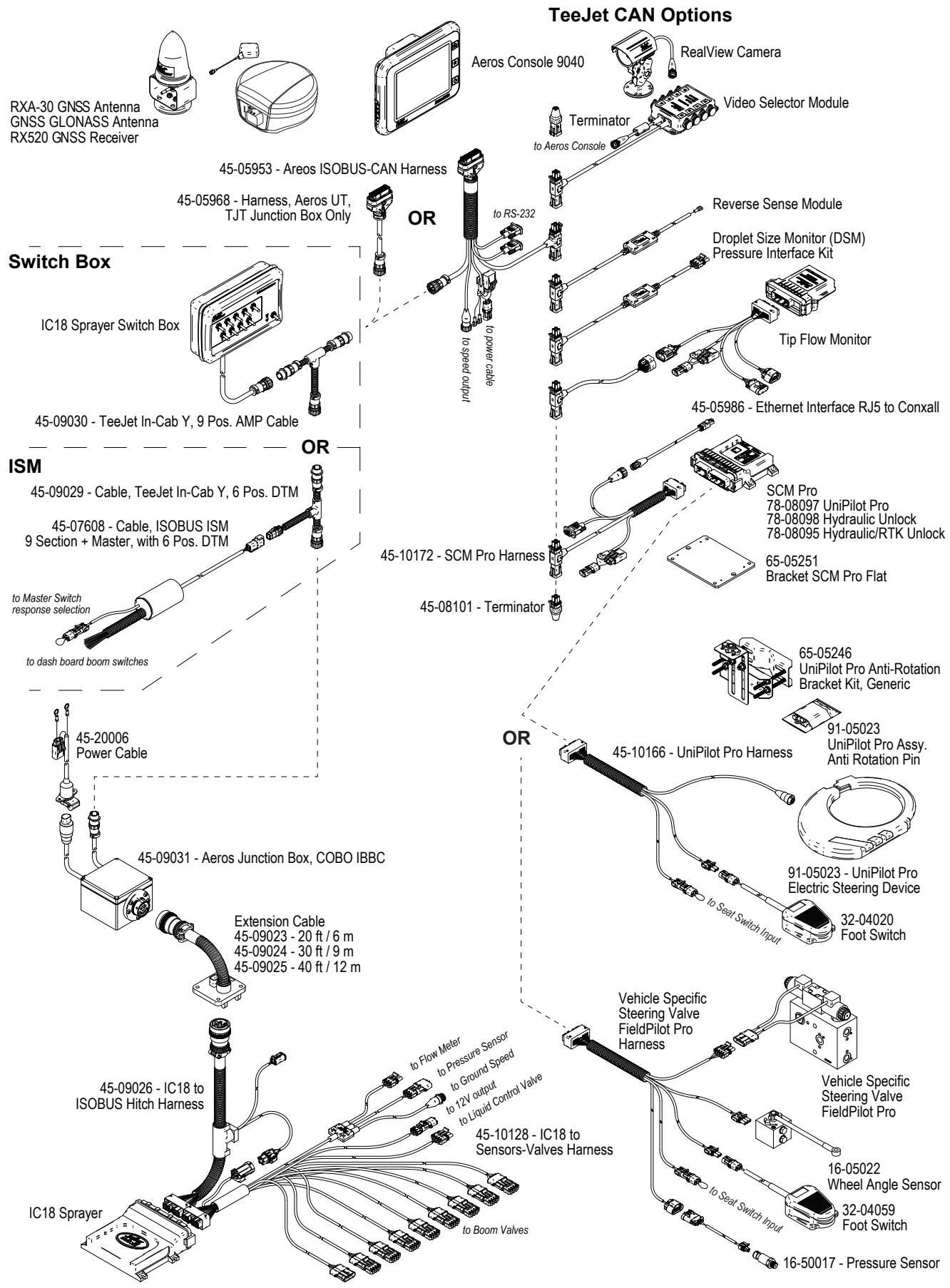
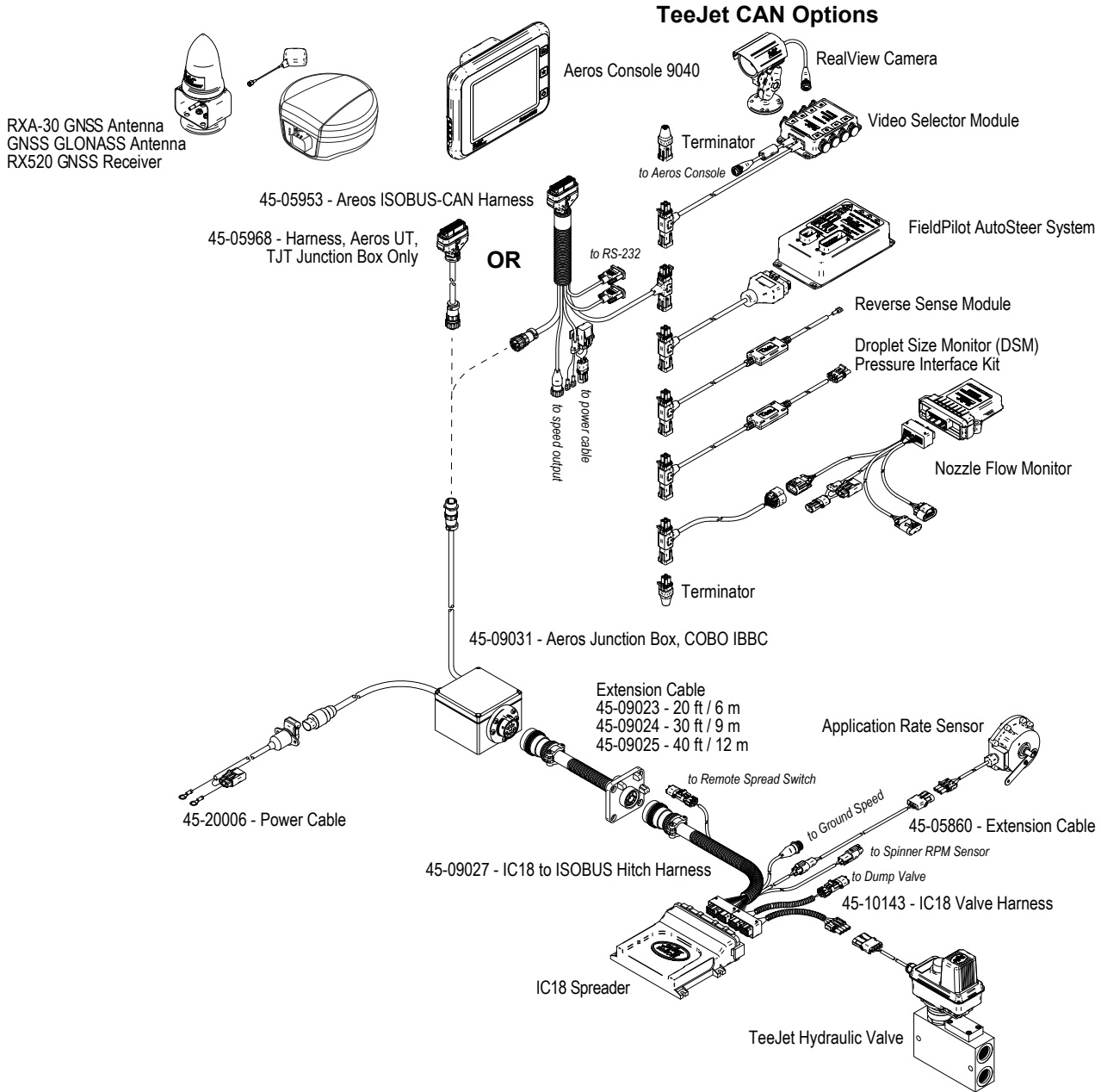

Figure A-3: Aeros IC18 spreader



APPENDIX B – AEROS CONSOLE MENU SETTINGS

This appendix lists the Aeros 9040 console's menu settings, and also provides the following:

- Settings available with an active job.
- Settings that can be made in the Aeros 9040 console itself, or using the Fieldware Link software.
- Settings that are included when exported to a profile from the Aeros console, or from Fieldware Link.

Symbol Key

In the following tables, these symbols indicate whether settings are available during an active job:

- ✓ Available during an active job
- ✗ Not Available during an active job
- ◀ Retained from console with profile
- ▶ Retained from Fieldware Link with profile

Configuration settings

Configuration settings	Available with active job	Can be edited in		Saved to exported profile in	
		Aeros 9040	Fieldware Link	Aeros 9040	Fieldware Link
Machine type	✗	✓	✗	✓	◀
GNSS antenna height.....	✗	✓	✓	✓	✓
Implement type	✗	✓	✓	✓	✓
Symmetric implement layout	✗	✓	✓	✓	✓
Multiple section output modules	✗	✓	✗	✓	▶
Number of implement sections	✗	✓	✓	✓	✓
Application/working width	✗	✓	✓	✓	✓
Droplet size monitor.....	✓	✓	✗	✓	▶
Nozzle selection					
Current nozzle	✗	✓	✗	✓	▶
Nozzle preset.....	✗	✓	✗	✓	▶
Nozzle spacing	✗	✓	✗	✓	▶
Applied alert.....	✓	✓	✗	✓	▶
Entry time	✓	✓	✗	✓	▶
Exit time.....	✓	✓	✗	✓	▶
Allow BoomPilot in reverse.....	✓	✓	✗	✓	▶
BoomPilot start mode	✓	✓	✗	✓	▶
BoomPilot icon.....	✓	✓	✗	✓	▶
Reverse signal delay	✓	✓	✗	✓	▶
Straight mode	Implement in-line offset direction.....	✗	✓	✓	✓
	Implement in-line offset distance	✗	✓	✓	✓
	Implement lateral offset direction.....	✗	✓	✓	✓
	Implement lateral offset distance.....	✗	✓	✓	✓
	Connection point in-line offset direction.....	✗	✓	✗	✓
	Connection point in-line offset distance	✗	✓	✗	✓
	Connection point lateral offset direction	✗	✓	✗	✓
	Connection point lateral offset distance.....	✗	✓	✗	✓
	Overlap	✓	✓	✓	✓
	Delay on/off times.....	✓	✓	✓	✓

Continued...

 Configuration settings		Available with active job	Can be edited in		Saved to exported profile in		
			Aeros 9040	Fieldware Link	Aeros 9040	Fieldware Link	
Implement <i>(continued)</i>	Spreader mode	Setup Type: TeeJet	x	✓	✓	✓	✓
		Antenna to disks in-line offset distance	x	✓	✓	✓	✓
		Implement lateral offset direction	x	✓	✓	✓	✓
		Implement lateral offset distance	x	✓	✓	✓	✓
		Overlap	✓	✓	✓	✓	✓
		Delay on/off times	✓	✓	✓	✓	✓
		Spread offset distance	x	✓	✓	✓	✓
		Section offsets	x	✓	✓	✓	✓
		Section lengths	x	✓	✓	✓	✓
		Setup Type: OEM	x	✓	✓	✓	✓
		Antenna to disks in-line offset distance	x	✓	✓	✓	✓
		Implement lateral offset direction	x	✓	✓	✓	✓
		Implement lateral offset distance	x	✓	✓	✓	✓
		Start/stop distances	x	✓	✓	✓	✓
	Staggered mode	Section start/stop offsets	x	✓	✓	✓	✓
		Section 1 in-line offset direction	x	✓	✓	✓	✓
		Section 1 in-line offset distance	x	✓	✓	✓	✓
		Implement lateral offset direction	x	✓	✓	✓	✓
Implement lateral offset distance		x	✓	✓	✓	✓	
Mapping and guidance	Mapping location	Overlap	✓	✓	✓	✓	
		Delay on/off times	✓	✓	✓	✓	
		Section offsets	x	✓	✓	✓	
		Mapping location	✓	✓	x	✓	◀
		Location name	✓	✓	x	✓	◀
	Guidance width	Mapping location in-line offset direction	✓	✓	x	✓	◀
		Mapping location in-line offset distance	✓	✓	x	✓	◀
		Mapping location lateral offset direction	✓	✓	x	✓	◀
		Mapping location lateral offset distance	✓	✓	x	✓	◀
		Guidance width	x	✓	✓	✓	✓
		Guidance sensitivity	✓	✓	x	x	x
		External lightbar	✓	✓	x	x	x
		External lightbar led brightness	✓	✓	x	x	x
External lightbar text brightness	External lightbar text brightness	✓	✓	x	x	x	
	External cross track	✓	✓	x	x	x	
	External swath number	✓	✓	x	x	x	
	External speed	✓	✓	x	x	x	
	External actual rate	✓	✓	x	x	x	
	External target rate	✓	✓	x	x	x	
	External applied product	✓	✓	x	x	x	
GNSS receiver configuration	GNSS type	x	✓	x	x	x	
	GNSS port	x	✓	x	x	x	
	GNSS status information	✓	✓	x	x	x	
	Programme	x	✓	x	x	x	
	PRN	x	✓	x	x	x	
	Show refresh GNSS position button	✓	✓	x	x	x	
Video	Reverse/Inverse	✓	✓	x	x	x	
Sensors	IOM pressure sensor	Maximum pressure rating	✓	✓	✓	✓	
		Low pressure alarm	✓	✓	✓	✓	
		High pressure alarm	✓	✓	✓	✓	
Nozzle flow monitor	Nozzle alarm percentage	✓	✓	x	✓	◀	
	Nozzle alarm delay	✓	✓	x	✓	◀	
	Number of sections	x	✓	x	✓	◀	
	Number of nozzles per section 1-15	x	✓	x	✓	◀	
	Nozzle balance percentage	✓	✓	x	✓	◀	
Nozzle flow monitor balance	x	✓	x	✓	◀		

Continued...

Aeros 9040 field computer

- INTRODUCTION
- HOME
- FULL SCREEN
- SETUP
- GNSS
- IMPLEMENT
- GUIDANCE
- RATE CONTROL
- APPENDIX

Configuration settings		Available with active job	Can be edited in		Saved to exported profile in		
			Aeros 9040	Fieldware Link	Aeros 9040	Fieldware Link	
ISOBUS	Machine speed broadcast	✓	✓	✗	✓	◀	
	Navigation speed broadcast	✓	✓	✗	✓	◀	
	Ground speed broadcast	✓	✓	✗	✓	◀	
	Time/date broadcast	✓	✓	✗	✓	◀	
	Universal terminal (UT) number	✓	✓	✗	✓	◀	
	Task controller (TC) number	✓	✓	✗	✓	◀	
	Number of UT object pools	✓	✓	✗	✓	◀	
	Number of ISOBUS control functions	✓	✓	✗	✓	◀	
Product	Product name	✗	✓	✓	✓	✓	
	Maximum rate colour	✓	✓	✗	✓	✗	
	Minimum rate colour	✓	✓	✗	✓	✗	
	Colour range	✓	✓	✗	✓	✗	
	Applied rate mapping upper limit	✗	✓	✗	✓	✗	
	Applied rate mapping lower limit	✗	✓	✗	✓	✗	
AutoSteer with FieldPilot Pro or UniPilot Pro	Manage vehicles	New	✗	✓	✗	✗	✗
		Load	✗	✓	✗	✗	✗
		Edit	✗	✓	✗	✗	✗
		Copy	✗	✓	✗	✗	✗
		Auto calibration	✗	✓	✗	✗	✗
		Adjust	✓	✓	✗	✗	✗
		Delete	✗	✓	✗	✗	✗
	Adjust	Manual disengage	✗	✓	✗	✗	✗
		Motor aggressiveness	✓	✓	✗	✗	✗
		UniPilot Pro freeplay	✓	✓	✗	✗	✗
		Steering response	✓	✓	✗	✗	✗
		Heading aggressiveness	✓	✓	✗	✗	✗
		Cross track error	✓	✓	✗	✗	✗
		Line acquisition	✓	✓	✗	✗	✗
		Reverse response	✓	✓	✗	✗	✗
		Tilt calibration	✗	✓	✗	✗	✗
		Wheel angle sensor (WAS) calibration	✗	✓	✗	✗	✗
		Select QI Values	✓	✓	✗	✗	✗
Maximum DOP	✓	✓	✗	✗	✗		
Transport mode	✓	✓	✗	✗	✗		
Service mode	✓	✓	✗	✗	✗		
Operator presence	✓	✓	✗	✗	✗		
AutoSteer	Assisted/auto steering enabled/disabled		✓	✓	✗	✓	◀
	Valve setup	Valve type	✗	✓	✗	✓	◀
		Valve frequency	✗	✓	✗	✓	◀
		Minimum left/right duty cycle	✗	✓	✗	✓	◀
		Maximum left/right duty cycle	✗	✓	✗	✓	◀
	Steering settings	Coarse steering adjustment	✓	✓	✗	✓	◀
		Fine steering adjustment	✓	✓	✗	✓	◀
		Deadband	✓	✓	✗	✓	◀
	Lookahead	✓	✓	✗	✓	◀	
	Valve test	✗	✓	✗	✓	◀	
	Valve diagnostics	✗	✓	✗	✓	◀	
	Options	Steering wheel sensor	✗	✓	✗	✓	◀
	Steering angle sensor	Enabled/disabled	✗	✓	✗	✓	◀
Sensor calibration		✓	✓	✗	✓	◀	
On line calibration		✓	✓	✗	✓	◀	
Tilt correction	Enabled/disabled	✗	✓	✗	✓	◀	
	Field level	✗	✓	✗	✓	◀	

Data management settings

 Data management settings		Available with active job	
Job data	Transfer	Export	✘
		Import	✘
		Delete	✘
	Manage	New	✘
		Copy	✘
		Delete	✘
Reports	Save PDF	✘	
	Save KML	✘	
	Save SHP	✘	
	Save all types	✘	
Options	Job Mode	✘	
Machine settings	Transfer	Export	✓
		Import	✓
		Delete	✓
	Manage	New	✓
		Copy	✓
		Delete	✓
		Save	✓
		Load	✘

Console settings

 Console settings		Available with active job
About	System information	✓
	Save	✓
Display	Colour scheme	✓
	LCD brightness	✓
	Screenshot	✓
	Screen calibration	✓
Cultural	Units	✓
	Language	✓
	Time zone	✓
Audio volume	Audio volume	✓
Demo GNSS	Start	✓
Feature unlock	BoomPilot for spreader	✓
	FieldPilot Pro / UniPilot Pro	✓

Tools settings

 Tools settings		Available with active job
Upload software	Device	✘
	Software	✘
Extras	Calculator	✓
	Units converter	✓

APPENDIX C – UNIT SPECIFICATIONS

Dimensions	26.4 x 21.0 x 8.89 cm	
Weight	1.5 kg	
Connectors	Power/CAN	35 pin AMPseal
	Camera	5 pin Conxall
Environmental	Storage	-10°C to +70°C
	Operating	0°C to +50°C
	Humidity	90% non-condensing
Display	800 x 600 resolution 8.4 in / 21.3 cm	
Input/Output	CAN, USB, RS232	
Power Requirement	< 9 watts @ 12 VDC	

APPENDIX D – SETTING RANGES

Press the option's name of any menu item to display a definition and range values of that item.

Figure A-4: Example of Information Text Box

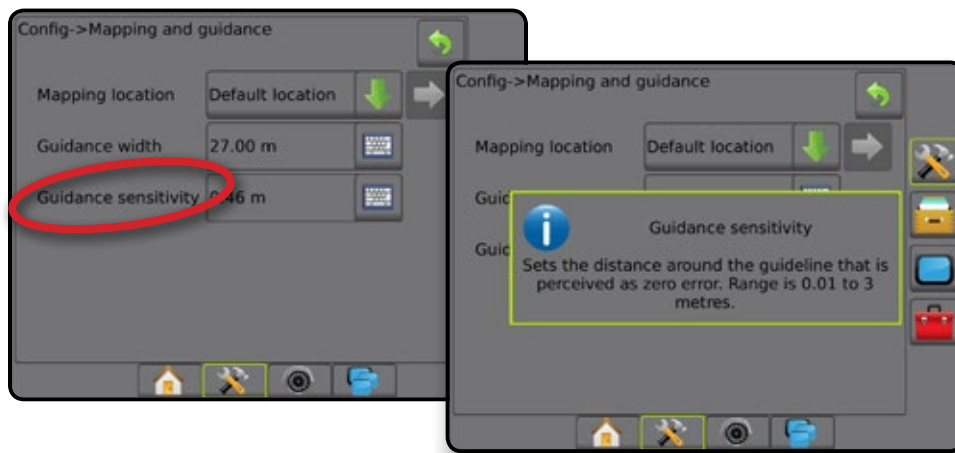

APPENDIX E – UTM COORDINATES AND ZONES

The Aeros 9040 field computer uses the Universal Transverse Mercator (UTM) coordinate system to track job locations. The UTM coordinate system divides the surface of the Earth into sixty numbered north-south zones, which are further divided into latitude zones designated by letters, as shown below.

Figure A-5: UTM coordinate system – Global

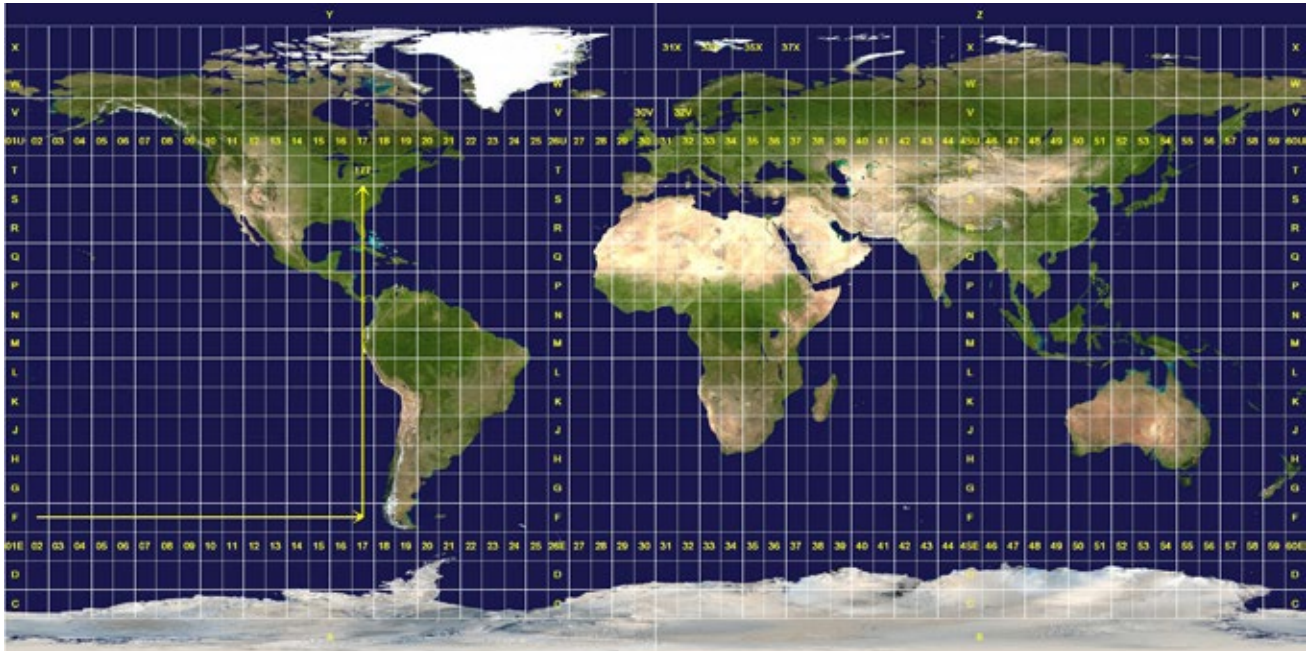

The Aeros console then tracks the UTM zones in which each product application job is performed. The UTM zone information is used to determine whether a job can be started/continued, or when in Advanced Job Mode to find the saved job closest to the vehicle's current position.

If a selected job is in a UTM zone other than the current or adjacent UTM zone, "Out of range" will be displayed next to Distance, and **Start job** or **Continue** will be disabled.

If a selected job has no recorded information, Distance will show "No data".

AEROS 9040

U S E R M A N U A L

Product Upgrades Available

- FieldPilot® Pro Auto Steering
- UniPilot® Pro Assisted Steering
- BoomPilot® Automated Boom Section Control
- Tilt Gyro Module
- Video Selection Modules for up to 8 Cameras
- External GNSS Receiver Or Antenna Upgrades
- Fieldware® Link Enhanced Data Organization Application
- Pressure Sensor Interface Kit for Droplet Size Monitor
- ISOBUS Rate Control
- Reverse Sense
- Tip Flow Monitoring



A Subsidiary of  *Spraying Systems Co.*

www.teejet.com