

Publication 1023
June 2022
Part No. 24215.23
Revision: 05.08.24



McCONEl

ROBOCUT / S300

REMOTE-CONTROLLED COMPACT MOWER

Operator Manual



IMPORTANT

VERIFICATION OF WARRANTY REGISTRATION



Dealer Warranty Information & Registration Verification

It is imperative that the selling dealer registers this machine with McConnel Limited before delivery to the end user – failure to do so may affect the validity of the machine warranty.

To register machines; log onto <https://my.mcconnel.com> and select 'Machine Registration' which can be found in the 'Warranty' section of the site. **Confirm to the customer that the machine has been registered by completing the verification form below.**

Registration Verification	Serial No. <input type="text"/>
Dealer Name:	
Dealer Address:	
Customer Name:	
Date of Warranty Registration:/...../..... Dealer Signature:	

Note to Customer / Owner

Please ensure the section above has been completed and signed by the dealer to verify your machine has been registered with McConnel Limited.

IMPORTANT: During the initial 'bedding in' period of a new machine it is the customer's responsibility to regularly inspect all nuts, bolts and hose connections for tightness and re-tighten if required. New hydraulic connections occasionally weep small amounts of oil as the seals and joints settle in – where this occurs it can be cured by re-tightening the connection – *refer to torque settings chart below*. The tasks stated above should be performed on an hourly basis during the first day of work and at least daily thereafter as part of the machine's general maintenance procedure.

CAUTION: DO NOT OVER TORQUE HYDRAULIC FITTINGS AND HOSES

Torque Settings for Hydraulic Fittings

Hydraulic Hose Ends		
BSP	Setting	Metric
1/4"	18 Nm	19 mm
3/8"	31 Nm	22 mm
1/2"	49 Nm	27 mm
5/8"	60 Nm	30 mm
3/4"	80 Nm	32 mm
1"	125 Nm	41 mm
1.1/4"	190 Nm	50 mm
1.1/2"	250 Nm	55 mm
2"	420 Nm	70 mm

Port Adaptors with Bonded Seals		
BSP	Setting	Metric
1/4"	34 Nm	19 mm
3/8"	47 Nm	22 mm
1/2"	102 Nm	27 mm
5/8"	122 Nm	30 mm
3/4"	149 Nm	32 mm
1"	203 Nm	41 mm
1.1/4"	305 Nm	50 mm
1.1/2"	305 Nm	55 mm
2"	400 Nm	70 mm

WARRANTY POLICY

WARRANTY REGISTRATION

All machines must be registered, by the selling dealer with McConnel Ltd, before delivery to the end user. On receipt of the goods it is the buyer's responsibility to check that the Verification of Warranty Registration in the Operator's Manual has been completed by the selling dealer.

1. LIMITED WARRANTIES

- 1.01. *All mounted machines supplied by McConnel Ltd are warranted to be free from defects in material and workmanship from the date of sale to the original purchaser for a period of 12 months, unless a different period is specified.
All Self Propelled Machines supplied by McConnel Ltd are warranted to be free from defects in material and workmanship from the date of sale to the original purchaser for a period of 12 months or 1500 hours. Engine warranty will be specific to the Manufacturer of that unit.*
- 1.02. *All spare parts supplied by McConnel Ltd and purchased by the end user are warranted to be free from defects in material and workmanship from the date of sale to the original purchaser for a period of 6 months. All parts warranty claims must be supported by a copy of the failed part invoice to the end user. We cannot consider claims for which sales invoices are not available.*
- 1.03. *The warranty offered by McConnel Ltd is limited to the making good by repair or replacement for the purchaser any part or parts found, upon examination at its factory, to be defective under normal use and service due to defects in material or workmanship. Returned parts must be complete and unexamined. Pack the component(s) carefully so that any transit damage is avoided. All ports on hydraulic items should be drained of oil and securely plugged to prevent seepage and foreign body ingress. Certain other components, electrical items for example, may require particular care when packing to avoid damage in transit.*
- 1.04. *This warranty does not extend to any product from which McConnel Ltd's serial number plate has been removed or altered.*
- 1.05. *The warranty policy is valid for machines registered in line with the terms and conditions detailed and on the basis that the machines do not extend a period of 24 months or greater since their original purchase date, that is the original invoice date from McConnel Limited.
Machines that are held in stock for more than 24 months cannot be registered for warranty.*
- 1.06. *This warranty does not apply to any part of the goods, which has been subjected to improper or abnormal use, negligence, alteration, modification, fitment of non-genuine parts, accident damage, or damage resulting from contact with overhead power lines, damage caused by foreign objects (e.g. stones, iron, material other than vegetation), failure due to lack of maintenance, use of incorrect oil or lubricants, contamination of the oil, or which has served its normal life. This warranty does not apply to any expendable items such as blades, belts, clutch linings, filter elements, flails, flap kits, skids, soil engaging parts, shields, guards, wear pads, pneumatic tyres or tracks.*
- 1.07. *Temporary repairs and consequential loss - i.e. oil, downtime and associated parts are specifically excluded from the warranty.*
- 1.08. *Warranty on hoses is limited to 12 months and does not include hoses which have suffered external damage. Only complete hoses may be returned under warranty, any which have been cut or repaired will be rejected.*
- 1.09. *Machines must be repaired immediately a problem arises. Continued use of the machine after a problem has occurred can result in further component failures, for which McConnel Ltd cannot be held liable, and may have safety implications.*
- 1.10. *If in exceptional circumstances a non McConnel Ltd part is used to effect a repair, warranty reimbursement will be at no more than McConnel Ltd's standard dealer cost for the genuine part.*

- 1.11. *Except as provided herein, no employee, agent, dealer or other person is authorised to give any warranties of any nature on behalf of McConnell Ltd.*
- 1.12. *For machine warranty periods in excess of 12 months the following additional exclusions shall apply:*
 - 1.12.1. *Hoses, exposed pipes and hydraulic tank breathers.*
 - 1.12.2. *Filters.*
 - 1.12.3. *Rubber mountings.*
 - 1.12.4. *External electric wiring.*
 - 1.12.5. *Bearings and seals*
 - 1.12.6. *External Cables, Linkages*
 - 1.12.7. *Loose/Corroded Connections, Light Units, LED's*
 - 1.12.8. *Comfort items such as Operator Seat, Ventilation, Audio Equipment*
- 1.13. *All service work, particularly filter changes, must be carried out in accordance with the manufacturer's service schedule. Failure to comply will invalidate the warranty. In the event of a claim, proof of the service work being carried out may be required.*
- 1.14. *Repeat or additional repairs resulting from incorrect diagnosis or poor quality previous repair work are excluded from warranty.*

NB Warranty cover will be invalid if any non-genuine parts have been fitted or used. Use of non-genuine parts may seriously affect the machine's performance and safety. McConnell Ltd cannot be held responsible for any failures or safety implications that arise due to the use of non-genuine parts.

2. REMEDIES AND PROCEDURES

- 2.01. *The warranty is not effective unless the Selling Dealer registers the machine, via the McConnell web site and confirms the registration to the purchaser by completing the confirmation form in the operator's manual.*
- 2.02. *Any fault must be reported to an authorised McConnell Ltd dealer as soon as it occurs. Continued use of a machine, after a fault has occurred, can result in further component failure for which McConnell Ltd cannot be held liable.*
- 2.03. *Repairs should be undertaken within two days of the failure. Claims submitted for repairs undertaken more than 2 weeks after a failure has occurred, or 2 days after the parts were supplied will be rejected, unless the delay has been authorised by McConnell Ltd. Please note that failure by the customer to release the machine for repair will not be accepted as a reason for delay in repair or submitting warranty claims.*
- 2.04. *All claims must be submitted, by an authorised McConnell Ltd Service Dealer, within 30 days of the date of repair.*
- 2.05. *Following examination of the claim and parts, McConnell Ltd will pay, at their discretion, for any valid claim the invoiced cost of any parts supplied by McConnell Ltd and appropriate labour and mileage allowances if applicable.*
- 2.06. *The submission of a claim is not a guarantee of payment.*
- 2.07. *Any decision reached by McConnell Ltd. is final.*

3. LIMITATION OF LIABILITY

- 3.01. *McConnell Ltd disclaims any express (except as set forth herein) and implied warranties with respect to the goods including, but not limited to, merchantability and fitness for a particular purpose.*
- 3.02. *McConnell Ltd makes no warranty as to the design, capability, capacity or suitability for use of the goods.*
- 3.03. *Except as provided herein, McConnell Ltd shall have no liability or responsibility to the purchaser or any other person or entity with respect to any liability, loss, or damage caused or alleged to be caused directly or indirectly by the goods including, but not limited to, any indirect, special, consequential, or incidental damages resulting from the use or operation of the goods or any breach of this warranty. Notwithstanding the above limitations and warranties, the manufacturer's liability hereunder for damages incurred by the purchaser or others shall not exceed the price of the goods.*
- 3.04. *No action arising out of any claimed breach of this warranty or transactions under this warranty may be brought more than one (1) year after the cause of the action has occurred.*

4. MISCELLANEOUS

- 4.01. McConnel Ltd may waive compliance with any of the terms of this limited warranty, but no waiver of any terms shall be deemed to be a waiver of any other term.*
- 4.02. If any provision of this limited warranty shall violate any applicable law and is held to be unenforceable, then the invalidity of such provision shall not invalidate any other provisions herein.*
- 4.03. Applicable law may provide rights and benefits to the purchaser in addition to those provided herein.*

McConnel Limited



For Safety and Performance...

ALWAYS READ THE BOOK FIRST



McCONEL LIMITED

**Temeside Works
Ludlow
Shropshire
England**

**Telephone: +44 (0)1584 873131
www.mcconel.com**



In line with our policy of constant improvement this publication may be periodically updated. To ensure you have access to the latest version of this manual please visit the manuals library on our website where an up-to-date version can be referenced online or downloaded.

To access manuals use the QR code opposite or the web address below;

<https://my.mcconel.com/service/pdf-manuals/pdf-operator-manuals/remote-control-technology-manuals/>

CONTENTS

General Information	1
Machine Description	2
Machine Identification	2
Features & Specifications	3
Technical Specifications	4
Safety Information.....	5
Machine Delivery	8
Machine Overview	9
Engine Compartment.....	9
Emergency Stop Buttons (E-Stop).....	10
Safety Devices & Emergency Stop (E-Stop).....	11
Remote-Control Unit	12
Joystick Controls	12
LCD Display	13
Emergency Stop Button.....	13
Engine Start / Stop	13
Engine Speed (RPM).....	13
Steering Bias Dial	14
Track Speed (Governor).....	14
Rotor Control Switch.....	14
Pair Button.....	14
Horn Button	14
Screen Operation.....	15
Pre-Operation Checks	21
Starting & Stopping the Engine.....	22
Machine and Remote-Control Synchronisation	22
Starting the Engine	22
Stopping the Engine	22
Emergency Stopping (E-Stop).....	23
Engine Speed (RPM).....	23
Auto Rev & Go.....	23
Driving & Manoeuvring.....	24
Forwards & Backwards Travel.....	24
Steering Direction	24
Steering Bias	25
Cutting Height Control	25
Cutting Deck	26
Cutting Height.....	26
Cutting Height Pre-Set.....	26
Activating Pre-Set Cutting Height	26
Rotor 'Stall'	26
Operating Position & Distance	27
Work Area Precautions	28
Operation	29
Recommended Safety Gear	29
Work Lighting Conditions.....	29
Track Protection	29

Brakes.....	31
Emergency Towing.....	31
Parking the Machine.....	31
Fuel.....	32
Fuel Tanks.....	33
Maintenance.....	34
Engine Oil.....	34
Oil Capacity & Type.....	34
Engine Oil Level.....	34
Air Filter.....	35
Filter Cartridge Removal.....	35
Filter Cartridge Cleaning.....	35
Rotors & Blades.....	36
Rotors.....	36
Blades.....	36
Blade Replacement.....	36
Belts.....	37
Access to Belts.....	37
Belts & Pulley's – Identification (Builds ► 2023).....	37
Belt Tension.....	37
Belts & Pulley's – Identification (Builds 2023 ►).....	38
Belt Tension.....	38
Rotor Belt – Tension Adjustment.....	39
Generator Belt – Tension Adjustment.....	39
Tracks.....	40
Track Replacement.....	40
Track Removal Procedure.....	40
Track Fitting Procedure.....	41
Track Tension Setting.....	41
Track Tension Check.....	41
Inverter Cooling Fans.....	42
Remote Battery Charging.....	42
Inline Fuel Filter.....	43
Emission Control System.....	43
Fuses & Relays.....	44
Cleaning & Storage.....	44
Troubleshooting.....	45
Service Schedule.....	47

GENERAL INFORMATION

Read this manual before fitting or operating the machine or accessory. Whenever any doubt exists contact your local dealer or the McConnell Service Department for assistance.

Only use 'Genuine McConnell Parts' on McConnell machinery and equipment.

DEFINITIONS: *The following definitions apply throughout this manual;*

⚠ DANGER

DANGER: Alerts to a hazardous situation which will result in death or serious injury if not observed carefully.

⚠ WARNING

WARNING: Alerts to a hazardous situation which could result in death or serious injury if not observed carefully.

⚠ CAUTION

CAUTION: Alerts to a hazardous situation which could result in damage to the machine and/or equipment if not observed carefully.

NOTICE

NOTICE: Specific or general information considered important or useful to emphasise.

LEFT HAND (LH) & RIGHT HAND (RH): *These terms are applicable to the machine when fitted to the tractor and viewed from the rear; these terms also apply to tractor references.*

SERIAL PLATE

All machines are equipped with a serial number plate containing important information relating to the machine including a unique serial number used for identification purposes.

Note: Images in this manual are provided for instruction and informational purposes only and may not show components in their entirety. In certain instances images may appear different to the actual machine; where this occurs the general procedure will be basically the same. E&OE.

NOISE LEVEL

L_{pA}
99

L_{pA} = the value indicates the maximum sound level perceived by the operator at a distance of 1m from the machine.

L_{wA}
107

L_{wA} = the value indicates the sound level outside the machine and refers to the noise perceived by those who are in the vicinity of the work area.

MACHINE DESCRIPTION

McConnel Robocut S300 machines are compact, all-terrain, remote-controlled mowers with bi-directional cutting capability for high performance efficient mowing/mulching of grass and herbaceous vegetation.

Machines feature a powerful Vanguard 28HP petrol engine with low fuel consumption and low emissions which, when combined with its hybrid electric drive, delivers smooth operation on all types of terrain including slopes of up to 55°.

The S300 is controlled via a precision digital remote-control unit giving users freedom to operate the machine in difficult or dangerous areas at distances of up to 150m.

This machine must only be used to perform tasks for which it was designed, use for any other purpose could be dangerous to persons and damaging to the machine.

MACHINE IDENTIFICATION

An identification plate is fitted to the rear of the machine in the location shown below.

It is advisable that owners keep a record of the serial number as stated on the identification plate and always quote the serial number when ordering replacement parts or when seeking service information or advice.

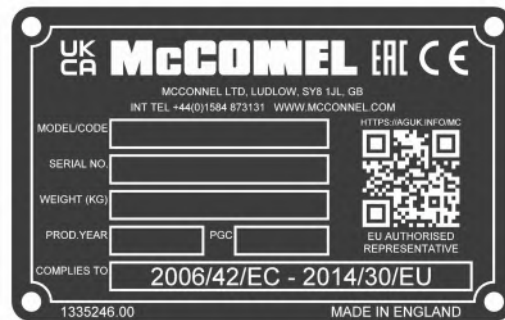
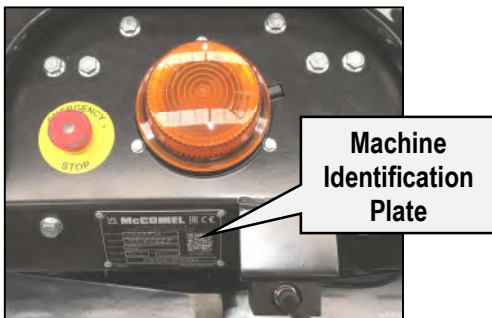

MACHINE & DEALER INFORMATION

Record serial numbers and dealer contact information here. Always quote serial numbers when ordering replacement parts or seeking service information and/or advice.	
Machine Serial Number:	Machine Installation Date:
Engine Serial Number:	
Machine Model Details:	
Dealer Name & Branch:	
Dealer Address:	
Dealer Telephone No:	
Dealer Email Address:	

FEATURES & SPECIFICATIONS

ROBOCUT S300

28HP

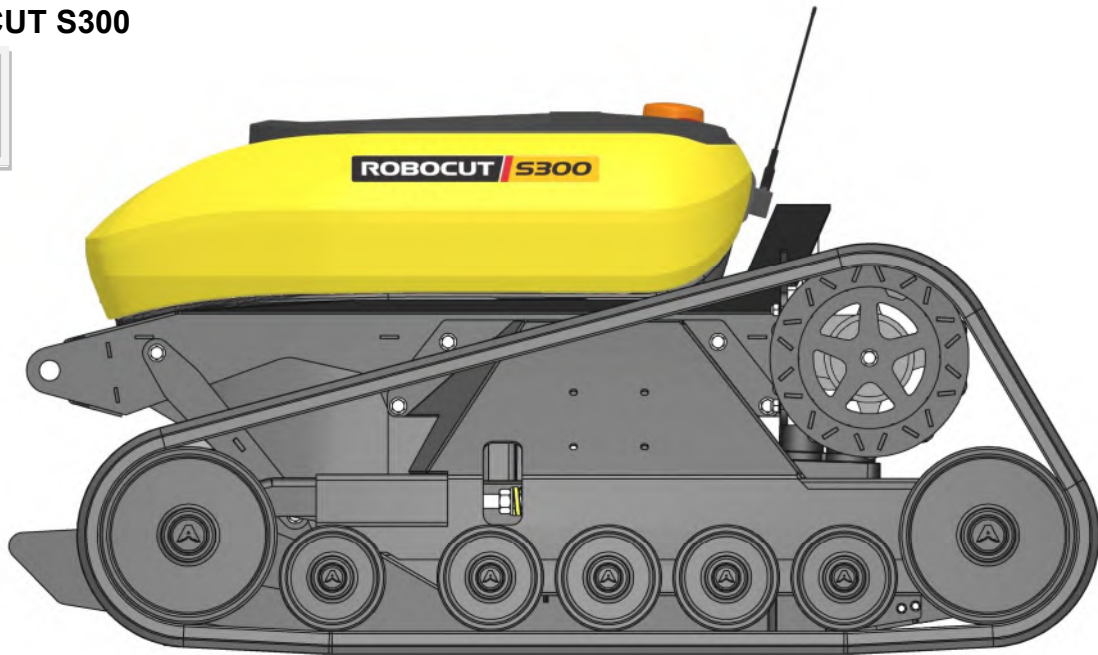

- 28HP (21kW) Vanguard Petrol Engine.
- Fully enclosed body panels.
- Tracked carriage.
- Electric motor driven tracks.
- Ability to operate on slopes up to 55°.
- Remote-controlled cutting height adjustment 25mm (1") to 150mm (6").
- Automatic height pre-set.
- Twin 'fast stop' rotors.
- Track tensioning system.
- Remote operation up to 150m.
- Fully proportional remote-control.
- Speed limiter.
- 50/50 weight distribution.
- User screen.
- GPS compatible.

TECHNICAL SPECIFICATIONS

Engine	Air-cooled, 2 cylinder, 4-stroke, OHV engine
Power	28HP / 21kW
Fuel type	Petrol
Track power	Electric motors
Travel speed	8kph / 5mph
Brakes	Short-circuit brake system
Ground pressure	2800 kg/m ² (6173 lbs/m ²)
Rotor No.	2
Rotor drive	Belt drive with braked clutch
Rotor shaft speed	3114 rpm
Cutting blades per rotor	2 updraft blades & 2 top cut blades
Area capacity (<i>approx.</i>)	5000 m ² /h @ 3 mph
Controls	Twin joystick remote-control
Control range	150m / 490 ft.
Ambient working temperature	-5 to +40 °C
Noise output level	L _{WA} = 107 dB
Bearing lubrication	Sealed bearing
Weight	480kg (1058 lbs.)
Cutting height	Min. 25mm (1") / Max. 150mm (6")
Cutting width	1120mm / 44"
Working angle	0 to 55° (<i>conditions permitting</i>)

SAFETY INFORMATION



Read the manual before using the machine

This machine has the potential to be extremely dangerous - in the wrong hands it can kill or maim; It is therefore imperative that both owner and operator of the machine reads the following section to ensure they are fully aware of the dangers that do, or may exist, and fully understand their responsibilities surrounding use and operation of this machinery.

The operator of this machine is responsible not only for their own safety but equally for the safety of all others who may come into the close proximity of the machine, as the owner you are responsible for both.

When the machine is not in use it should be parked in a safe location on a firm level site with power turned off.

In the event of any fault being detected with the machine's operation it must be stopped immediately and not used again until the fault has been corrected by a qualified technician.

- ⚠** *Before starting the machine, the operator must read and understand all aspects of use and maintenance of the machine as stated in this manual.*
- ⚠** *The machine must only be used by a responsible adult who is familiar with all aspects relating to safe operation.*
- ⚠** *Do not operate the machine while under the influence of alcohol or drugs.*
- ⚠** *The machine must not be operated by children or non-authorized persons.*
- ⚠** *Operators must know the meaning of all operation and safety decals on both the machine and the remote-control unit.*
- ⚠** *Operators must know the procedure for switching the machine off normally and the correct procedure for using the Emergency Stop.*
- ⚠** *Do not attempt to use the machine if the Emergency Stop switch is damaged or malfunctioning.*
- ⚠** *Never use the machine with safety guarding removed or defective.*
- ⚠** *Operators should practice operation on flat open ground to familiarise themselves with driving and manoeuvring the machine before attempting to use it on sloping ground.*
- ⚠** *Operators should practice manoeuvring the machine around obstacles, without the rotors running, before using the machine for work purposes.*
- ⚠** *Never operate the machine if your vision is blocked or obscured by obstacles such as vehicles, buildings, hedges, fences etc.; move to a safe position where you have a clear, un-interrupted view of the entire machine.*
- ⚠** *Never operate the machine when standing directly in the line of travel.*
- ⚠** *Do not use the machine on sand piles, gravel, or other similar loose materials.*

- ⚠ Only operate the machine in good light conditions.*
- ⚠ Never start or run the machine in an enclosed area or building.*
- ⚠ Keep the machine clean to avoid build ups of dry materials that could ignite on hot components.*
- ⚠ Never stand directly below a machine that is working or parked on a slope.*
- ⚠ Always operate the joystick control slowly; rapid or jerky movements could cause the machine to 'rear up' causing loss of control.*
- ⚠ When operating the machine with the rotors running the operator must remain in a safe position at least 30 ft. (9.15m) away from the machine; always switch the rotors off before approaching the machinery.*
- ⚠ When using the machine, the operator should place themselves in a position that provides optimum visibility over the entire work area.*
- ⚠ Never leave a running machine unattended; always switch the engine off and shut-off main power.*
- ⚠ Always stop and switch the machine off if persons or animals enter the work area; do not restart the machine until they are at a safe distance.*
- ⚠ Never use the machine to perform tasks it was not designed for.*
- ⚠ Never ride or allow others to ride on the machine.*
- ⚠ Keep children away from a working or running machine at all times; stop the machine immediately if children are in the close vicinity.*
- ⚠ Never allow children to play on or near a machine even when it is parked up.*
- ⚠ Always inspect the work area prior to operation and remove stones, glass, metal, wire or any other foreign objects that are hazardous. Immovable hazards should be suitably 'marked' so they can be easily avoided.*
- ⚠ Take extra care when operating the machine on slopes or uneven ground; there is increased risk of objects being thrown from rotating equipment when working in these conditions.*
- ⚠ The machine can be used on slopes up to a maximum of 55° providing the surface is dry and firm.*
- ⚠ Should a machine overturn, a suitable crane or winch should be used to recover it; keep all persons at a safe distance before and during recovery.*
- ⚠ Do not operate the machine in foggy or frosty conditions as there is increased risk of accidents.*
- ⚠ Take extra care when working in close proximity to electrical cables; in some circumstances, operating the machine under overhead power lines can result in loss of radio signal causing the engine to be deactivated.*
- ⚠ Do not operate the machine close to vehicles or properties where there is risk of damage by objects accidentally ejected from the cutting unit.*
- ⚠ It is the user's responsibility to protect persons in or near the work zone.*
- ⚠ When servicing or maintaining the machinery no-one should be allowed beneath it when it is raised unless it is securely supported on suitable ramps or stands.*
- ⚠ Never attempt to service or maintain the machine whilst it is running; always switch off the engine, switch off the main power and remove the remote-control switch key.*
- ⚠ When transporting the machine on another vehicle or trailer the engine must be switched off and the machine chocked and secured with suitable ropes or chains.*
- ⚠ Check the condition of cutting blades and their fixings on a regular basis; never use a machine with damaged or missing blades or loose fixings.*
- ⚠ Always clean the machine after use; if machine components are hot, allow them to cool to a safe temperature before cleaning. Never use solvent based chemicals for cleaning.*

- ⚠ *When operating in excessively dusty conditions work may need to be interrupted on a regular basis to remove any build ups of dust on components that could cause overheating.*
- ⚠ *Ensure engine is switched off and Emergency Stop switch is in the 'off' position before refuelling.*
- ⚠ *Test the Emergency Stop switch before each period of work to ensure it functions correctly.*
- ⚠ *Never leave machine and control unit unattended in one place; the machine could be started and used by un-authorized persons.*
- ⚠ *Any inspection, service or maintenance of the machine must only be performed with machine switched off and control unit switch key removed.*
- ⚠ *Always wear suitable safety gear at all times when performing service or maintenance work on the machine.*
- ⚠ *Rotors must always be switched off when manoeuvring outside of the work zone.*

Fire & Fuel Specific

- ⚠ *Extinguish all cigarettes, cigars, pipes and other sources of ignition.*
- ⚠ *Only use approved fuel containers*
- ⚠ *Do not remove fuel caps or add fuel with the engine running or when machine is hot. Wherever possible refuel the machine before work when the engine is cold. If refuelling during work, switch off the engine and allow it to cool before re-fuelling the tanks.*
- ⚠ *Do not refuel indoors or in enclosed spaces.*
- ⚠ *Do not store machine and/or fuel containers where there are open flames or sparks.*
- ⚠ *Do not fuel the machine where there are open flames or sparks.*
- ⚠ *In the event of a fuel spillage, do not attempt to start the machine until the spillage has been cleaned up and fuel vapours have dissipated.*
- ⚠ *To prevent risk of fires: keep the machine free of grass, leaves or other debris build-up; clean up oil or fuel spillage and remove any fuel-soaked debris; allow machine to cool before storing.*

Personal Protective Equipment (PPE)

We recommend that the following personal protective equipment is worn during operation and/or maintenance of this machinery; overalls, safety shoes, safety goggles, ear protection, safety helmet, protective gloves, respiratory protection, shin/knee protection.



Although the information stated here covers a wide range of safety subjects, it is impossible to predict every eventuality that can occur under differing circumstances whilst operating this machine. No advice given here can replace 'good common sense' and 'total awareness' at all times, but it will go a long way towards the safe use of your McConnel machine.



Operating, servicing and maintaining this equipment can expose you to chemicals including gasoline, diesel fuel, lubricants, petroleum products, engine exhaust, carbon monoxide, and phthalates, which are known to the State of California to cause cancer and birth defects or other reproductive harm. To minimize exposure, avoid breathing exhaust, do not idle the engine except as necessary, service your vehicle in a well-ventilated area and wear gloves or wash your hands frequently when servicing your vehicle. Battery posts, terminals and related accessories contain lead and lead compounds, chemicals known to the state of California to cause cancer, birth defects or other reproductive harm. For more information go to www.P65Warnings.ca.gov. This website, operated by California's Office of Environmental Health Hazard Assessment, provides information about these chemicals and how individuals may be exposed to them.

MACHINE DELIVERY

Robocut S300 machines are delivered ready for use pre-filled with all the necessary lubricants and fluids other than fuel. Before use, all delivery packaging should be removed and the machine fully inspected; if there are any signs of damage or missing components it must be reported to your supplier/dealer immediately.

Standard items supplied;

- Machine with mounted receiver.
- Remote-control Transmitter Unit c/w Battery Pack.
- Reserve Battery Pack.
- Battery Charger.
- Belt for Remote-control Unit.
- User Manual.

Machine Handling

The machine is equipped with 4 lifting points for raising the machine with overhead lifting gear. Ensure the equipment used does not foul or come into contact with the machines body panels during the lifting procedure; use spreader beams if required. The deck must be placed into the fully lowered position when lifting the machine with overhead lifting gear.

Lifting Point Locations

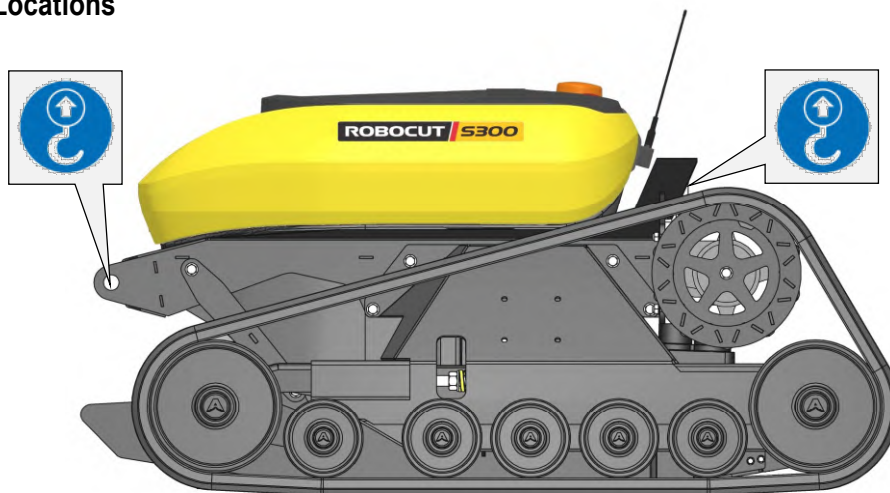

Lifting Equipment

Suitable overhead lifting equipment with a minimum Safe Working Load (SWL) in excess of 500kg should be used for handling the machine.

Ensure the machine is kept balanced and level at all times during the lifting procedure.

All operatives and bystanders must remain at a safe distance from the raised machine.

▲ DANGER

Keep all persons at a safe distance from the raised machine.

▲ DANGER

Lifting of the machine should only be performed on a firm level site.

Machine Transportation

The lifting points on the machine can also be used as lash points; these positions should be used to secure the machine for transportation on flatbed vehicles or trailers.

▲ CAUTION

Machine must be fully secured at all times when transporting on a vehicle.

MACHINE OVERVIEW

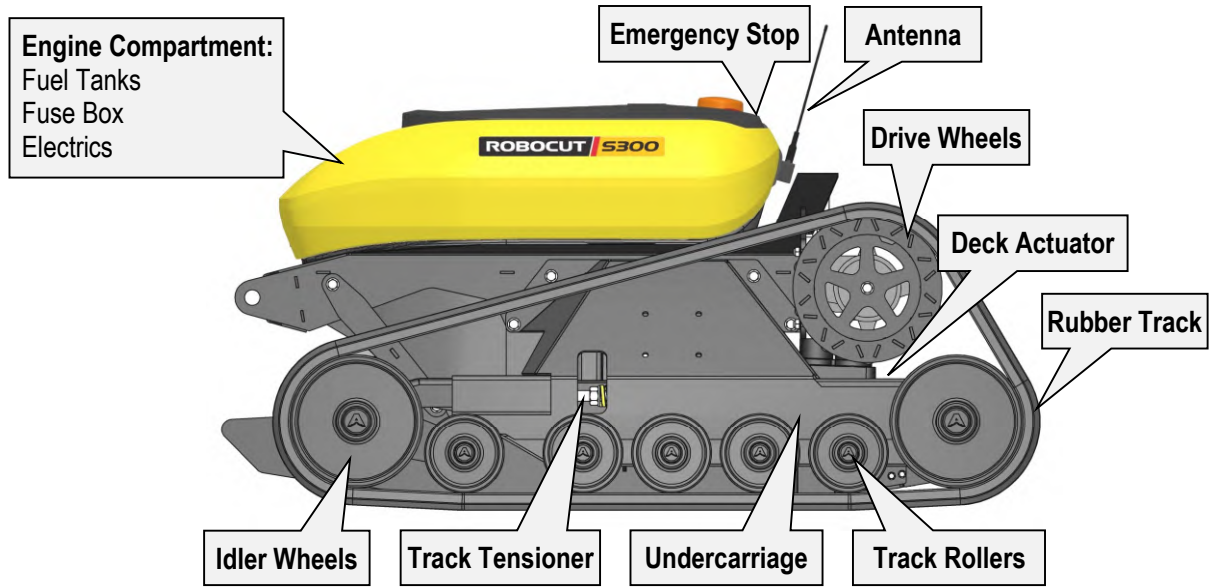

ENGINE COMPARTMENT

Component Identification

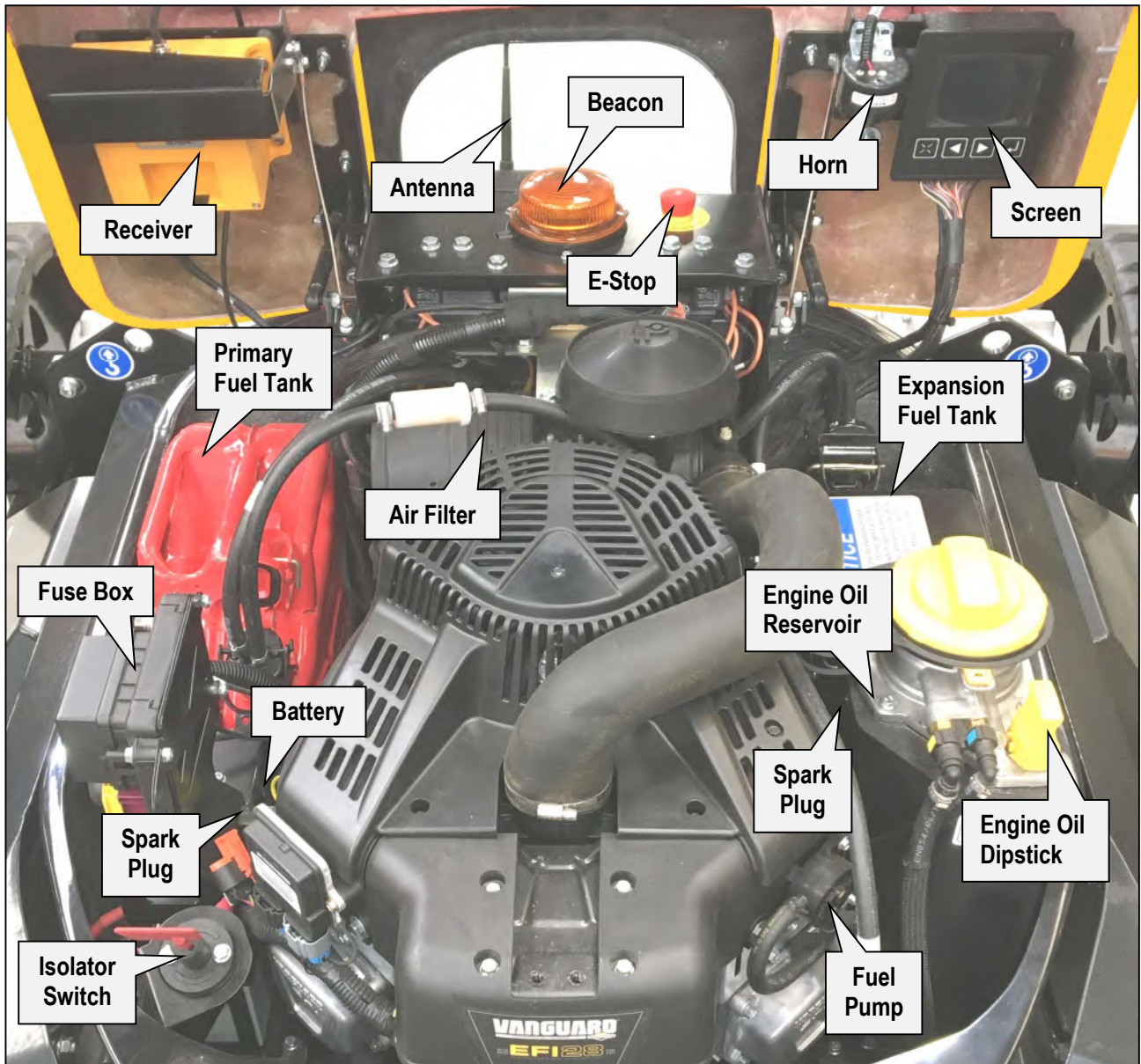

EMERGENCY STOP BUTTONS (E-STOP)

Location of Emergency Stop Buttons

E-Stop buttons are located on top of the machine at the rear of the engine compartment and on the remote-control unit.

The E-Stop button on the machine also acts as the main power ON/OFF button for the machine; it is illuminated when power to the machine is ON (E-Stop de-activated). If the E-Stop is activated the light in the button will go out and power to the machine is switched OFF.



CAUTION

E-Stops are provided for use in an emergency situation only; they **must not** be used as a shortcut method of switching off the engine during normal use.

Main Power ON/OFF

It is important that the machine E-Stop button (Power ON/OFF button) is always switched OFF (E-Stop activated) when the machine is not being used; this is for both safety reasons and to preserve battery power.



IMPORTANT

ALWAYS activate the E-Stop to shut-off power to the machine when it is not being used.

SAFETY DEVICES & EMERGENCY STOP (E-Stop)

Automatic Emergency Safety Features

As the machine is operated by remote-control and the user is not 'physically' controlling the machine, specific safety features have been built in to protect the operator, third party persons, and the machine itself; these are as follows;

DANGER / RISK SITUATION	AUTOMATIC SAFETY FEATURE
Machine beyond signal reception area or radio signal blocked	EMERGENCY STOP will activate
Radio signal failure	EMERGENCY STOP will activate
Another machine on same frequency operating in the area	EMERGENCY STOP will activate

Manual Emergency Safety Feature

In addition to the automatic safety features stated above **the operator can immediately stop all machine movements and shut off the engine by pressing an E-Stop button;** these are located on the remote-control unit and on the top of the machine.

In all instances above, emergency stopping of the machine will take a maximum of 0.2 seconds from execution of the automatic or manual command and the following actions will occur;

- **Machine movement / operations and functions will be immediately halted.**
- **Engine will be immediately switched off.**

Note; after using E-Stop the machine will cease to function completely; to regain functions and continue operating the E-Stop button must be reset and a normal re-start performed.



*E-Stop button light on machine will be extinguished when it is pressed (activated).
The machine's E-Stop button illuminates when the stop is deactivated.*

In the unlikely event of movement malfunction

If machine movements perform in an unexpected and/or incorrect manner follow the instructions below;

- 1) Release the forwards/backwards movement joystick.
The control is equipped with automatic zero position; on release it will automatically return to the central (stop) position, this action will halt track motion.
- 2) Press E-Stop button on the control unit.

 DANGER Do not approach the machine if it is moving.

- 3) Press machine's E-Stop button.
- 4) Turn control unit power switch to the OFF position (*anti-clockwise*) and remove the key.

If movement malfunction is experienced contact your Authorised Dealer or McConnel Service; DO NOT attempt to use or operate the machine until advice has been sought.

REMOTE-CONTROL UNIT

⚠ DANGER

Operators must wear personal safety gear at all times whilst operating the machine and stand in a safe operating position with a clear view of the machinery and the work area.

Controls Identification

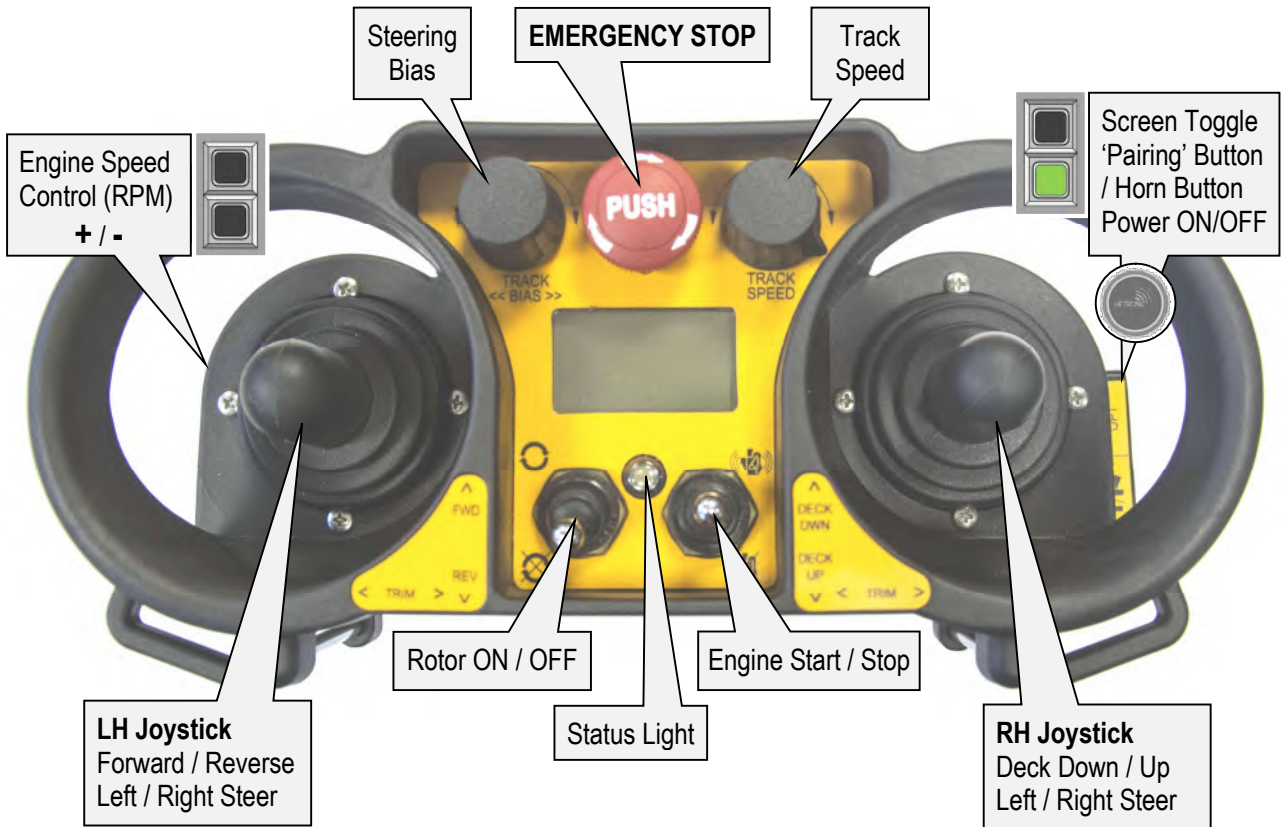

Joystick Controls

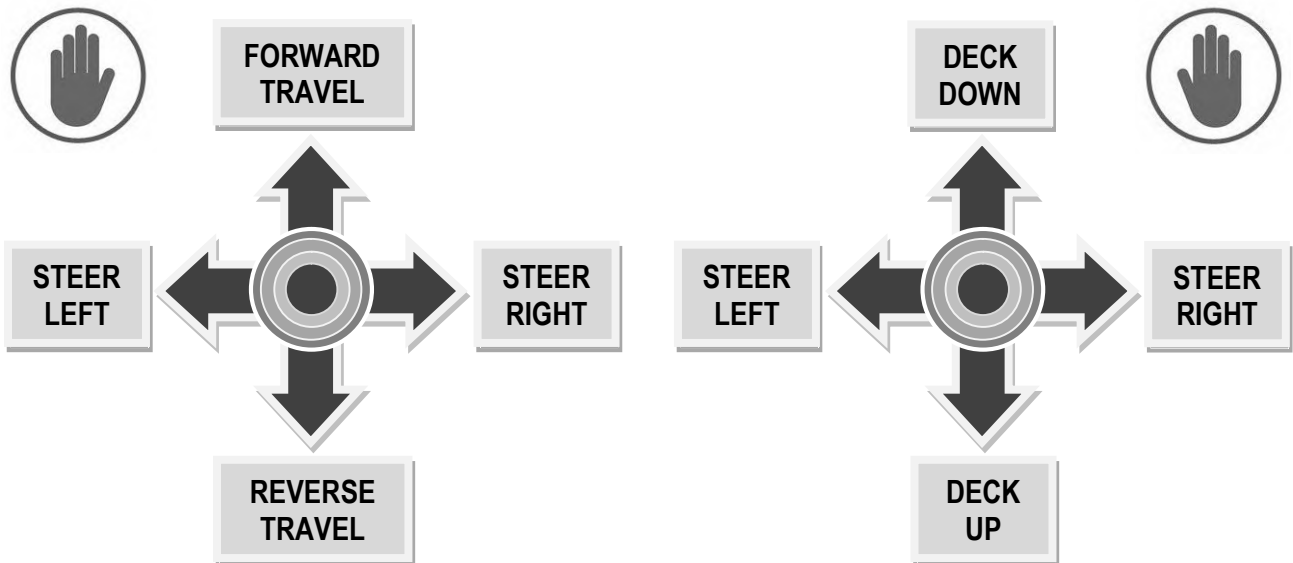

NOTE: Steering can be controlled using either the LH or the RH joystick; if joysticks are operated in opposing directions simultaneously the RH joystick will take priority to avoid conflicting commands.

Control Unit – Function Operation

LCD Display

Reports the following information;

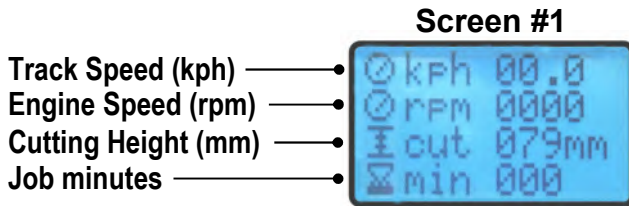

Job minutes records current rotor engaged time until the job timer is manually reset – refer to 'Job Timer Reset' procedure.

Press **OPT** button  to 'toggle' screens

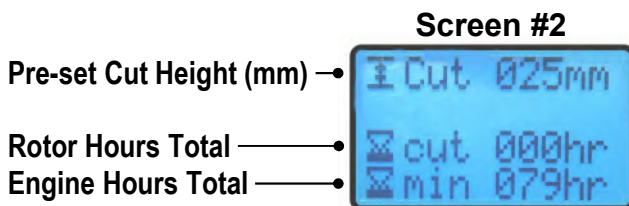

*Pre-set cut height can be set to user's own preference; this setting is then the height the deck will automatically move to when **OPT** button is pressed for >3 seconds.*

Continue to operate the joystick if you want to power the deck past the pre-set cut height.

When altering height, screen will display the new cutting height after approximately 3 seconds.

Refer to cutting height section for details of setting the cutting height pre-set.

Status Light

Indicates the status of the Remote-control Unit;

Illuminated **GREEN** = '**CORRECT**' Status.

Illuminated **RED** = '**PROBLEM**' Status.

Emergency Stop Button



PUSH button for '**EMERGENCY STOP**'.
Rotate clockwise to 'Reset'.



Engine Start / Stop



Engine START: Hold switch in 'UP' position until the engine starts.



Switch automatically returns to its central position when released.



Engine STOP: Hold switch in 'DOWN' position until the engine stops.

Engine Speed (RPM)

Control for engine RPM.

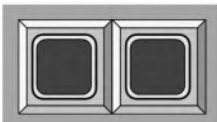

Press + Button: Increase engine RPM.

Press - Button: Decrease engine RPM.

Refer to 'Auto Rev & Go' in Starting & Stopping the Engine section for further information.

Steering Bias Dial

Control for setting steering angle bias when operating on sloped ground.



Left Steering Bias: Turn control dial to the left to select desired LH bias.

No Steering Bias: Place control dial into the central position.

Right Steering Bias: Turn control dial to the right to select desired RH bias.

Track Speed (Governor)

Sets maximum top speed limit.



Increase Maximum Speed Limit: Rotate control dial clockwise.

Decrease Maximum Speed Limit: Rotate control dial anti-clockwise.

NOTE: lower maximum speed settings will provide proportionally 'finer' speed control.

Rotor Control Switch

Rotor ON and OFF control.



ON : Place switch in 'UP' position to start the rotor.



OFF: Place switch in the DOWN position to 'STOP' rotor.

With ENGINE OFF

Pair Button & Screen 1 ◀▶ 2 Swap (Synchronisation mode)



Press  Button: Will 'Pair' machine with remote-control unit. Horn will sound to confirm, and software version will be displayed.



When synchronised: Press  Button to view screen 2.

Press  Button to return to screen 1.

1) Toggle Metric & Imperial Units

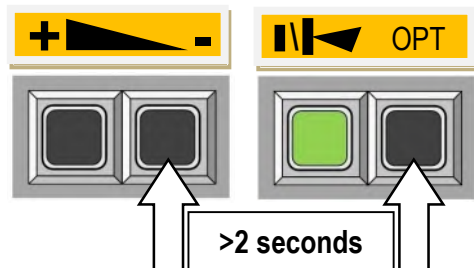

1) Press and hold the Speed (-) & Option button for >2 seconds to toggle between metric and imperial units.

2) Job Timer Reset

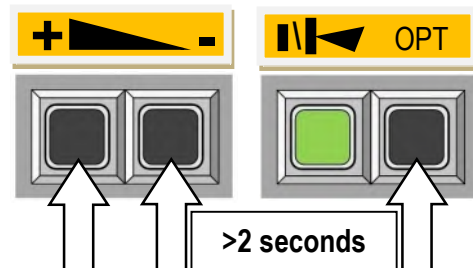

2) Press and hold Speed (+), Speed (-) & Option button together for >2 seconds to reset the job timer, *job minutes are displayed at the bottom of screen 1.*

With ENGINE RUNNING

Horn Button & Actuate Pre-set Cutting Height (Operation mode)



Press  Button: Sounds the horn (Operator controlled warning).



Press  Button: Hold for > 3 seconds to move deck actuator to the pre-set cut height (Set on screen 2).

SCREEN OPERATION

⚠ WARNING Screen must not be accessed with engine running; screen features are live and changes to some settings will cause machine movement.

Screen Unit Location

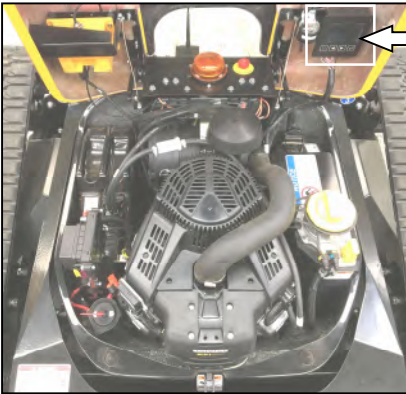

Screen Unit



Screen Controls



'Home' Button



Navigation Buttons



'Enter' Button



Boot Screen

When machine is 'powered ON', the screen will display the McConnell boot screen until the system is active; when the control system is ready the Home screen will be displayed.



Home Screen

The Home screen displays the following information;

- Remote signal strength
- Date
- Time
- Current Job Hours
- Engine Hours



Press 'Navigate Right' button to access the Settings Menu screen.



Settings Menu Screen

The settings menu offers the following categories;

- Warnings & Errors
- Time & Date Settings
- User Settings
- Machine Info & Settings

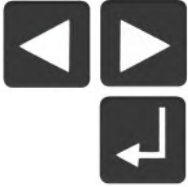

Use 'Navigation' buttons to highlight the required category.

Press 'Enter' button to access the selected (highlighted) menu.

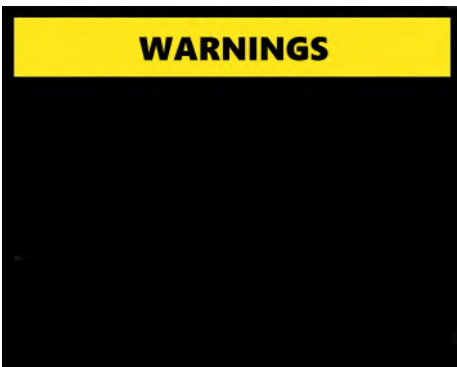

Warnings & Errors Screen

This screen displays currently active Warnings & Errors. *If the screen is blank the machine is error free.*



Press 'Navigate Right' button to enter Warnings & Errors history screen.

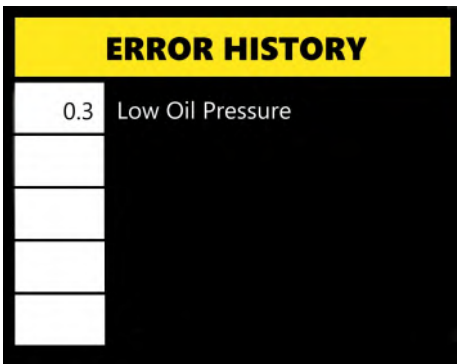

Warnings & Errors History Screen

This screen reports past Warnings & Errors; *the 5 most recent warnings & errors will be listed.*



Press 'Home' button to exit the screen.

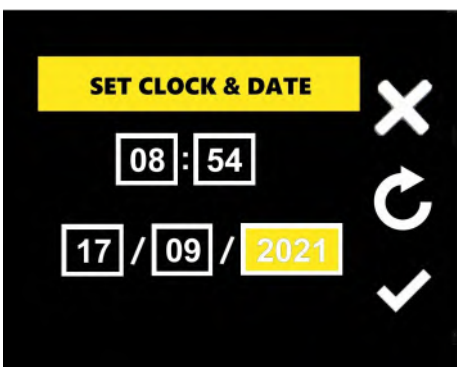

Time & Date Settings Screen

Screen allows user to edit and set the time and date;



Use 'Navigation' buttons to highlight the required data box.



Press 'Enter' button to edit the data in the selected box.



Use 'Navigation' buttons to edit the value.



Press 'Enter' to confirm and save change.



Repeat the above procedure for each area.



Navigate to select the 'Tick' icon.



Press 'Enter' button to save changes and exit screen.

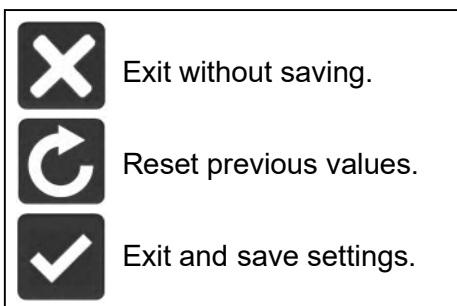

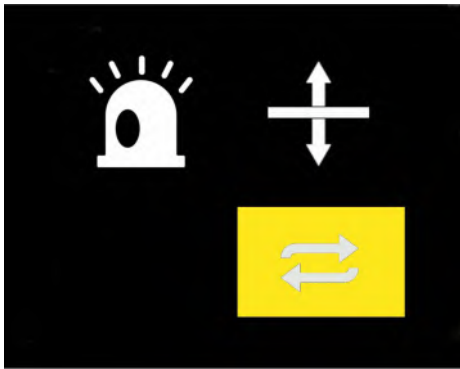

User Settings Screen

This screen displays the following user settings;

- Beacon Settings
- Cutting Deck Settings
- Joystick Swap Settings



Navigate to required category and press 'Enter' button to access those settings.

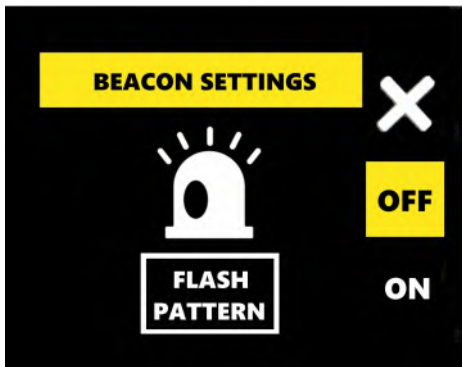

Beacon Settings Screen

This screen offers the following settings;

- Beacon 'OFF'
- Beacon 'ON'
- Beacon Flash Pattern



Navigate to select the required option.



Press 'Enter' to activate the option.

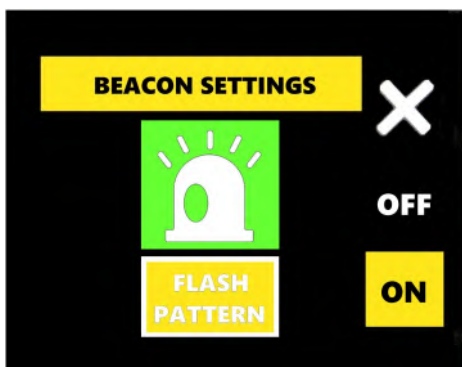

Beacon Flash Pattern Options

Beacon must be 'ON' to edit the 'Flash Pattern'.



Navigate to select 'FLASH PATTERN'.



Press 'Enter' to edit the flash pattern.



Use 'Navigation' buttons to scroll patterns; beacon flashing simultaneously changes.



With desired flash pattern running, press 'Enter' button to activate that pattern.



Press 'Home' button to exit the screen.

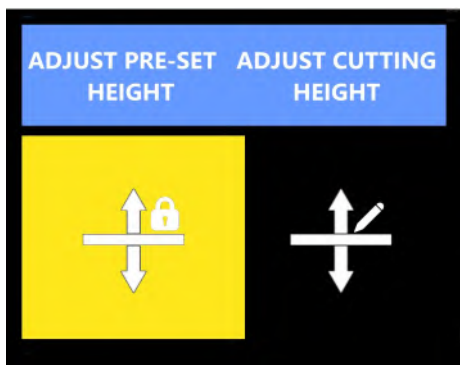

Cutting Deck Settings Screen

This screen offers the following settings;

- Pre-Set Height Adjustment
- Cutting Height Adjustment



Use 'Navigation' buttons to select category.



Press 'Enter' button to access the settings.

NOTICE

Pre-Set Cutting Height and Cutting Height can be adjusted and set by the user via the operator screen or directly from the remote control unit; refer to Cutting Deck section of the manual for details of changing the settings via the control unit.

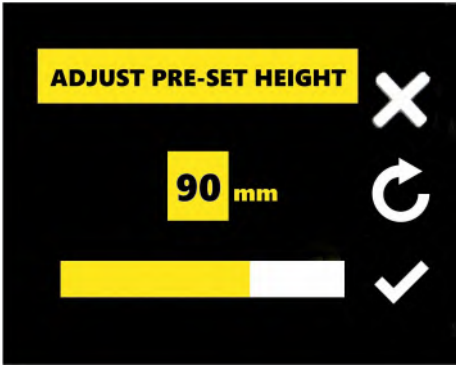

Adjust Pre-Set Height Screen

This screen allows the user to change the pre-set cutting height to any figure between 25-150mm (1" - 6").



Use 'Navigation' buttons to select the current height figure shown onscreen.



Press 'Enter' button to permit editing.



Use 'Navigation' buttons to edit the value to the required pre-set cutting height.



Press 'Enter' button to exit editing.



Navigate to select the 'Tick' icon.



Press 'Enter' button to save change and exit screen.

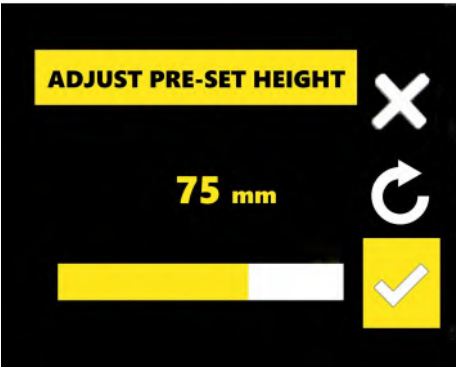

⚠ WARNING

When adjusting the following 'Cutting Height' setting, the machine itself will change its height position in line with adjustments being made onscreen; users must ensure they remain clear of moving components at all times whilst performing this procedure.

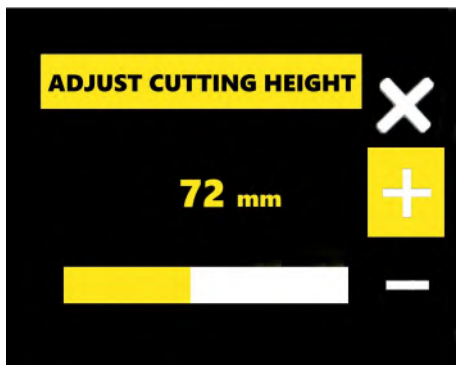

Adjust Cutting Height Screen

This screen allows the user to set the cutting height to any figure between 25-150mm (1" - 6").



Use 'Navigation' buttons to select '+' or '-' icons on the screen.



Press 'Enter' button repeatedly to edit the height setting; deck will move in unison.



Press 'Home' to save and exit the screen.

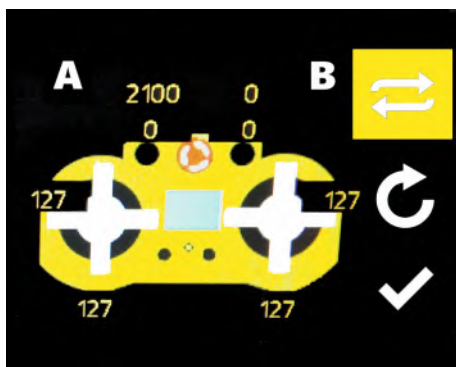

Joystick Swap Settings Screen

This screen allows the user to 'swap' the back and forth control functions of the joysticks.



Use 'Navigation' buttons to select 'swap' icon on the screen.



Press 'Enter' button to swap joysticks functions; from 'A/B' to 'B/A' or visa-versa.



Navigate to select the 'Tick' icon.



Press 'Enter' to save and exit the screen.

Back & Forth Joystick Functions
 Default: A Travel / B Deck
 Swap Mode: A Deck / B Travel

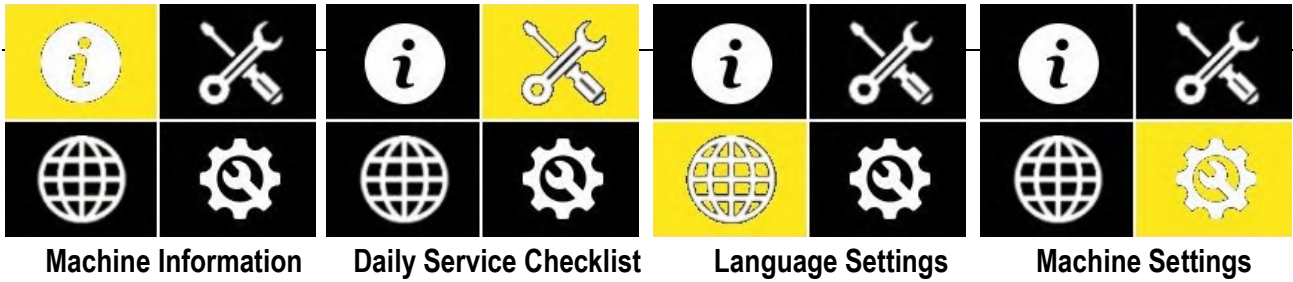

Machine Information

Daily Service Checklist

Language Settings

Machine Settings

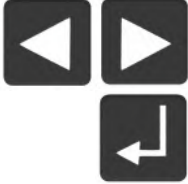

Use 'Navigation' buttons to select category.

Press 'Enter' button to access that screen.

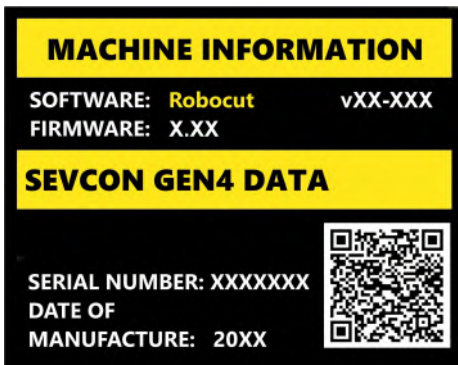

Machine Information Screen

This screen provides the following information;

- Software Version
- Firmware Version
- Controller Information
- Machine Serial Number
- Machine Year of Manufacture
- QR Code for direct access to S300 Manuals

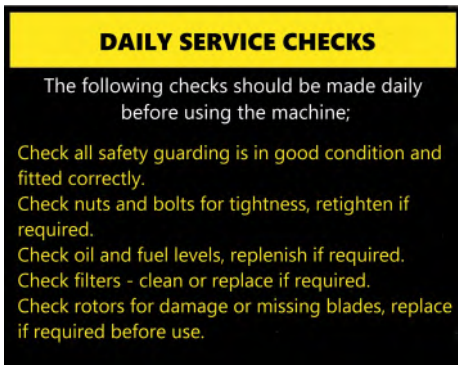

Daily Service Checklist Screen

This screen provides a list of Service Checks that users must perform daily prior to using the machine.



Language Settings Screen

Currently unavailable, standard English (British) language files installed.

Machine Settings & Report Screens

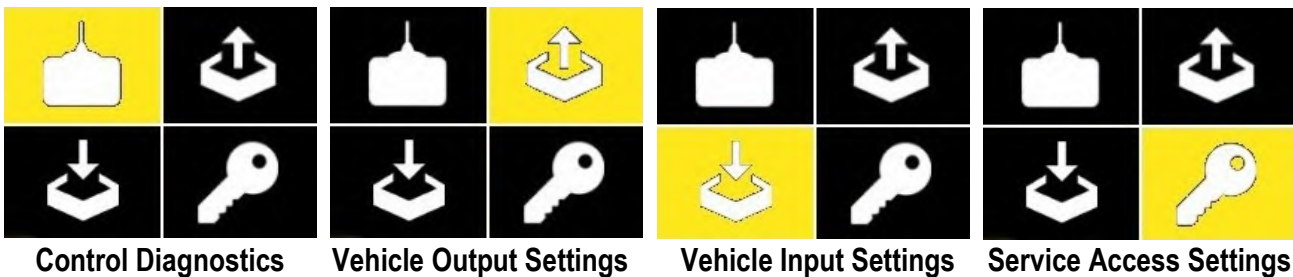

Control Diagnostics

Vehicle Output Settings

Vehicle Input Settings

Service Access Settings

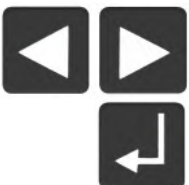

Use 'Navigation' buttons to select category.

Press 'Enter' button to access that screen.

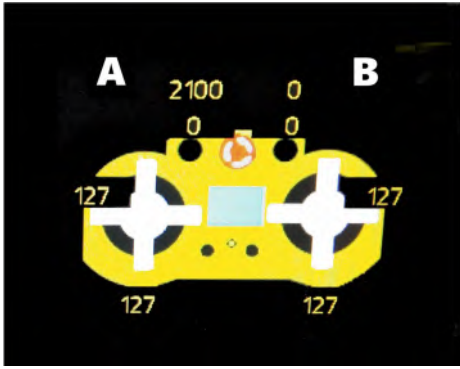

Control Diagnostics Screen

This screen is used for signal diagnostic purposes to test and report if each control is functioning correctly.

If a control unit malfunction is suspected, users should contact their local dealer or McConnell Service who may request this screen is accessed in order to perform tests and report on the data displayed.



Testing of controls here must be performed with ENGINE OFF.

VEHICLE OUTPUTS		
DECK ACTUATOR POSITION	905	
THROTTLE POSITION	1960	
BATTERY VOLTAGE	13.3	
GENERATOR VOLTAGE	0	
MOTOR TORQUE	0	0
MOTOR TEMP	0	0
MOTOR CAP VOLTS	0.0	0.0
CURRENTS	0.0	0.0
HEATSINK TEMP	0	0

Vehicle Outputs Screen

Information reporting screen for vehicle outputs.



Toggling the 'Enter' button in this screen will allow you to switch between Output & Input screens.



Press 'Home' button to exit screen.

VEHICLE INPUTS	
SPEED	0
LINE CONTACTOR	0
THROTTLE VOLTS	0
STEER ANGLE	0

Vehicle Inputs Screen

Information reporting screen for vehicle inputs.



Toggling the 'Enter' button in this screen will allow you to switch between Input & Output screens.



Press 'Home' button to exit screen.

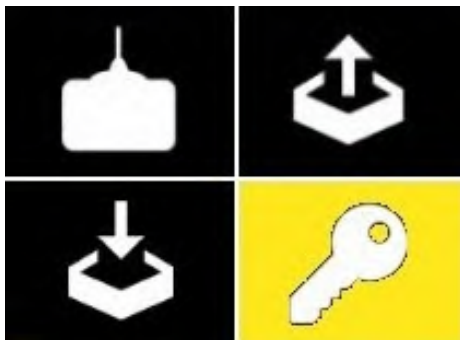

Service Settings: Factory & Dealer Access only

The Service Settings menu is a password protected area for authorised dealers and factory use only.



PRE-OPERATION CHECKS

⚠ WARNING All checks and inspections of the machine should be performed with the machine parked on firm level ground with the engine switched off and the machine E-Stop activated (Power OFF).

The following checks should be made daily before using the machine;

- Check all safety guarding is in good condition and fitted correctly.
- Check nuts and bolts for tightness, retighten if required.
- Check oil and fuel levels, replenish if required.
- Check filters – clean or replace if required.
- Check rotors for damaged or missing blades, replace if required before use.
- Check machine is free from debris.

STARTING & STOPPING THE ENGINE

CAUTION

Before attempting to start the engine ensure you have read and understood the manual and observed all safety instructions surrounding use of the engine and the machine.

WARNING

Engine must only be started in open air, never in an enclosed environment.

Before Starting

- Observe all safety instructions.
- Ensure machine is in the open air and not in an enclosed environment.
- Check fuel level; replenish if required.

Engine Starting Procedure

Machine and Remote-Control Synchronisation

Check E-Stop buttons are in their de-activated (out) position; rotate E-Stop buttons clockwise to release the stop, machine E-Stop must be illuminated.



Switch 'ON' the remote-control unit by turning the power switch clockwise; control unit will emit a series of 'buzzing' sounds and screen will display the 'unsynchronised' symbol.

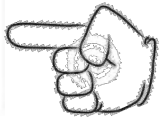

Remote Control Unit ON/OFF Switch



Unsynchronised Status



Press GREEN button on right-hand side of remote-control unit to 'pair' the remote-control unit with the machine.

When synchronised, the remote-control unit screen will display screen #1 information.



Synchronised Status

Starting the Engine



Engine Start: Hold engine switch in 'UP' position until the engine starts.



Release switch when engine starts; the switch will return to its central position.

Stopping the Engine



Engine STOP: Hold switch in 'DOWN' position until the engine stops.



Release switch when engine stops; the switch will return to its central position.

When the engine has stopped, activate machine E-Stop button to power-off the machine.

Emergency Stopping (E-Stop)

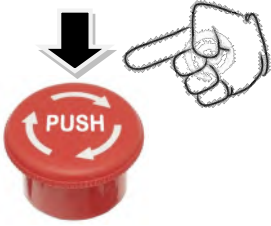

In emergency situations, the engine and all machine functions can be immediately stopped by pressing an E-Stop button.

E-Stop buttons are located on the remote-control unit and on the top of the machine to the rear of the engine compartment.

When an E-Stop button is pressed (activated), all machine movements and functions will cease immediately, and the engine will be automatically switched off.

If an E-Stop button has been activated, that button must be reset before the machine can be re-started.

Engine Speed (RPM)

The machine has 2 pre-set engine speed settings that are controlled using (+) & (-) buttons located on the left-hand side of the operator control unit, the speed settings are;

Idle speed: *engine runs at low RPM – tracks operate at reduced power / rotor will not engage.*

Max-speed: *engine runs at high RPM – tracks and rotor can be operated.*

When engine speed (+) button is operated the engine RPM will increase to maximum RPM and will remain at that speed until the engine speed (-) button is subsequently pressed.

On initial start-up the engine will run at the idle speed setting.

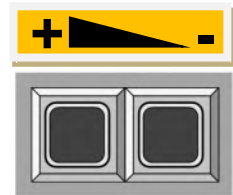

Selection of the required engine speed is by using (+) or (-) button.

For work the engine speed must be set at maximum RPM setting.

Auto Rev & Go

Operation of the rotor clutch and/or tracks will automatically switch the engine speed to maximum RPM; the engine RPM will automatically revert to idle speed if the rotor clutch is disengaged for more than 5 seconds and/or track movement ceases for more than 5 seconds.

For work, it is recommended that the rotor clutch is switched on (engaged) with the engine running at idle speed and allow the system to automatically switch the engine speed to maximum.

DRIVING & MANOUEVERING

⚠ WARNING

Operation of the machine must only be performed by a responsible person who has read the manual and is familiar with the machine's controls and all aspects relating to the safe use of this equipment.

⚠ CAUTION

It is advisable that all new operators practice using the machine, without the rotors running, in a safe open area to familiarise themselves with the controls and movements of the machine.

Forwards & Backwards Travel

Operation of the machine's forward and backwards movements are controlled by the **left-hand joystick** on the remote controls;

Push the lever forwards to move the machine forwards.

Pull the lever backwards to move the machine backwards.

The joystick operates proportionally; the further the lever is moved the faster the machine travels.

The maximum speed available will be determined by the particular position of the track speed dial.



Turn dial anti-clockwise = reduces top speed limit
Turn dial clockwise = increases top speed limit

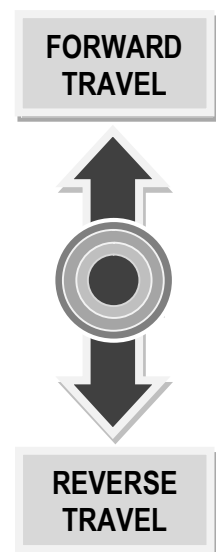

NOTE: Travel is only possible when engine speed is at maximum RPM

Steering Direction

Operation of the machine's left and right movements can be controlled using either the **left-hand** or **right-hand joystick** on the remote controls;

Move left-hand OR right-hand lever to the left to steer left.

Move left-hand OR right-hand lever to the right to steer right.

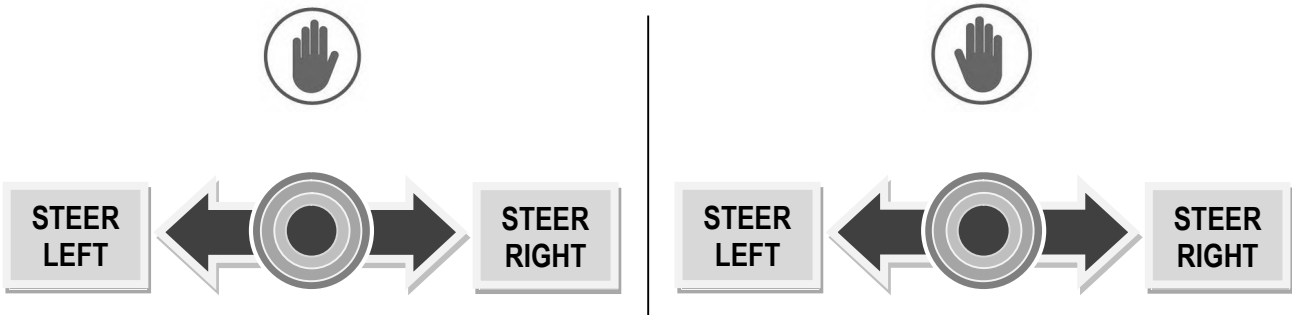

NOTE: if joysticks are operated in opposing directions simultaneously the RH joystick will take priority.

Steering Bias

The steering bias feature allows the operator to set a 'degree of steer' for manoeuvring the machine across slopes, setting and adjustment is performed using the steering bias dial;



- Turn control dial to the left to select a desired degree of left steering bias.
- Turn control dial to the right to select a desired degree of right steering bias.
- Place control dial into the central position to de-select steering bias.

The further the dial is rotated in each direction the greater the degree of bias.

Operating with Bias

Steering must still be monitored and controlled by the operator in the normal manner, but steering corrections required to guide the machine will be greatly reduced.

Bias Control

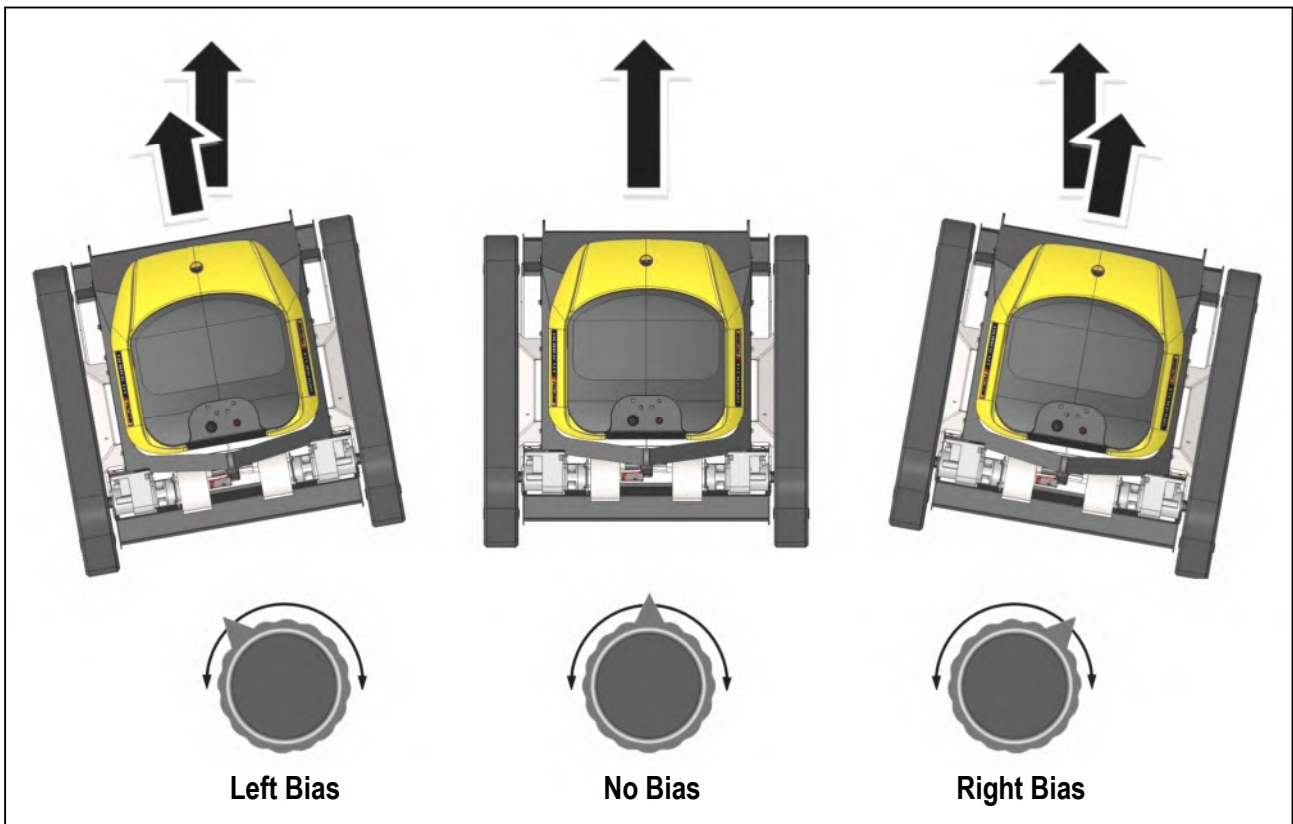

Cutting Height Control

The deck height is controlled by forward and backwards operation of the **right-hand joystick**;



- Move joystick forwards to lower the cutting height.
- Move joystick backwards to raise the cutting height.

Providing it is safe to do so, the cutting height may be adjusted whilst the machine is in motion.



CUTTING DECK

Cutting Height

The machine can be set to cut at any height between 25mm (1") and 150mm (6").

The cutting height selected should be one that offers the desired finish. If the material being cut is particularly tall or thick or causes the engine to 'labour' whilst working, it is advisable to begin cutting at a high setting and progressively reduce the height until the required finish is achieved. In these conditions reducing the forward travel speed is advisable and will help to preserve the operation life of the rotor drive belt.

Cutting Height Pre-set

The controls feature a 'pre-set' height setting allowing the user to set a default cutting height that the machine automatically returns to when the **OPT** button is pressed and held for >3 seconds.

Setting the Pre-set Cutting Height

The procedure for setting the pre-set cutting height is as follows:

With machine running, press  **OPT** button on control unit to display screen #2.

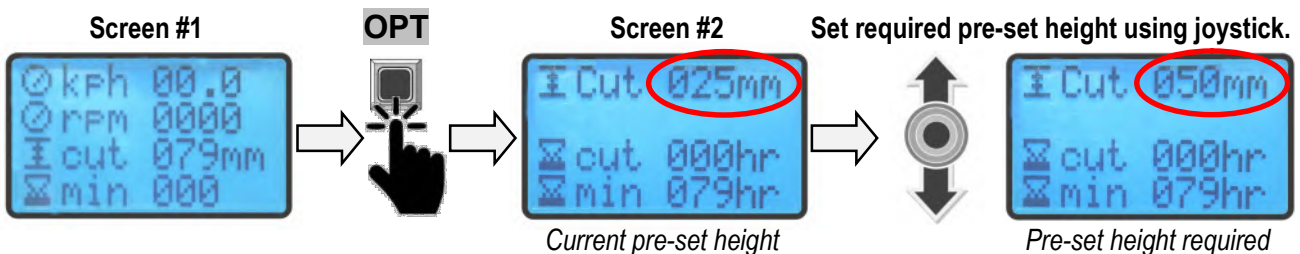

When required pre-set height is displayed, press  button to return to screen #1.

The pre-set cutting height has now been set at your chosen height and will remain as that setting unless subsequently changed.

Activating Pre-set Cutting Height

To move the deck to its pre-set cutting height, press and hold the  **OPT** button for >3 seconds; the deck will automatically move to the pre-set height.

Rotor 'Stall'

If the rotors should 'stall' for any reason during operation, forward movement will be automatically halted; this is a built-in safety feature designed to protect the machine.

If a stall occurs, the beacon will flash, *if not already on*, and the 'stall icon' will be displayed on the remote control screen.

To restore rotor operation, switch off the rotor and reduce the engine RPM to idle by pressing the engine speed (-) button; with the engine running at idle, press the green synchronisation button to allow cutting to resume.

To restore drive, the control joystick must be returned to its central position before any further travel movement will be permitted.

If the cause of the stall was due to impact with a solid or immovable object, the machine must be reversed away from its position with the rotor switched off, and the cause of the stall investigated.

After any form of impact, the machine must be inspected for signs of damage, ensure the machine is switched off and isolated before performing a thorough inspection. Operations should only continue if the machine is undamaged and safe to use.

OPERATING POSITION & DISTANCE

Only operate the machine from a safe distance and position that provides an unobstructed view of the machine and work area. When operating this machinery you are responsible for your own safety and the safety of all others who enter the work area.

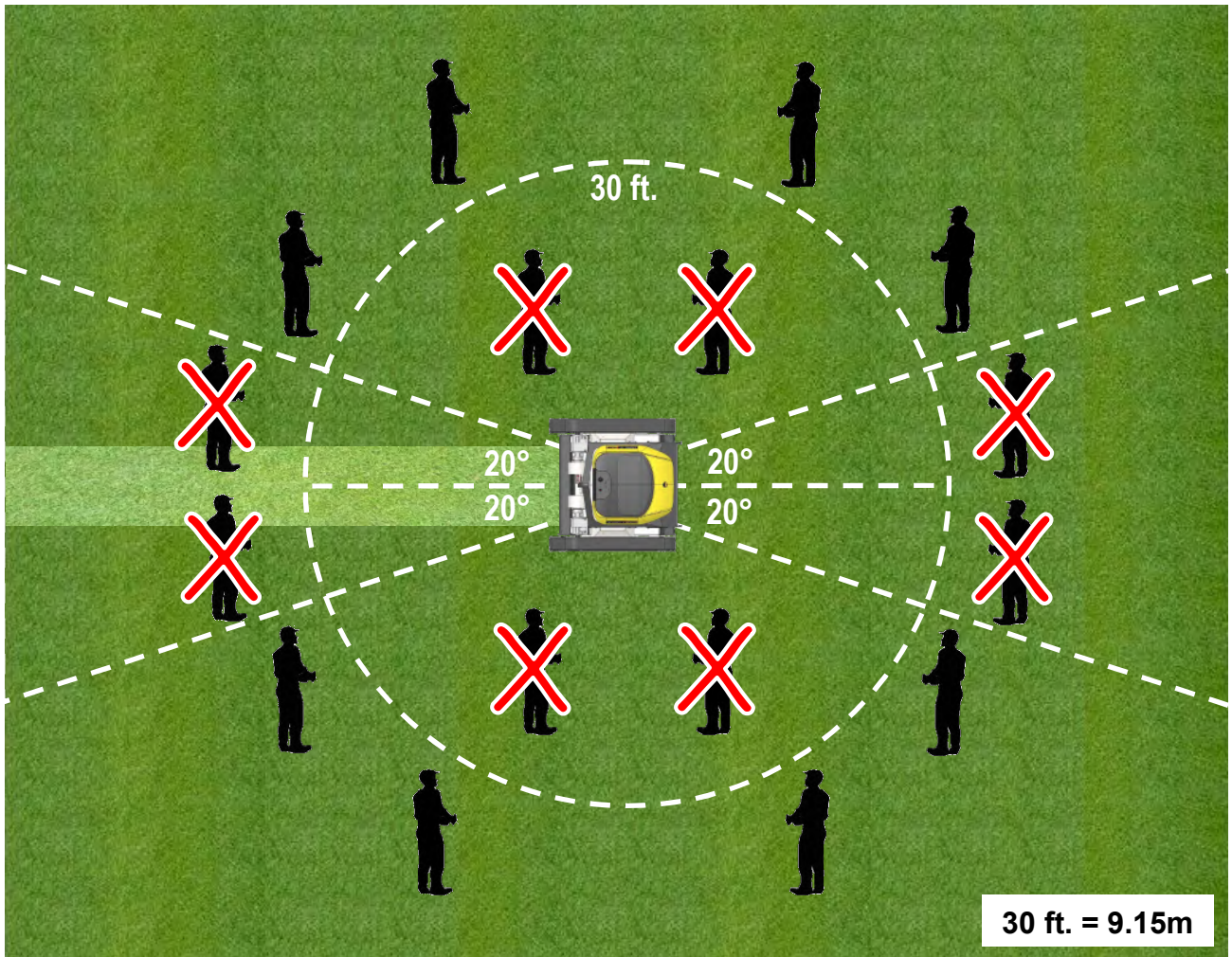

Working on Slopes

When working on slopes do not operate from any position directly below the machine, where possible it is safer to stand in a suitable location above the machine.

⚠ WARNING Do not operate the machine on ground or surfaces that are slippery underfoot.

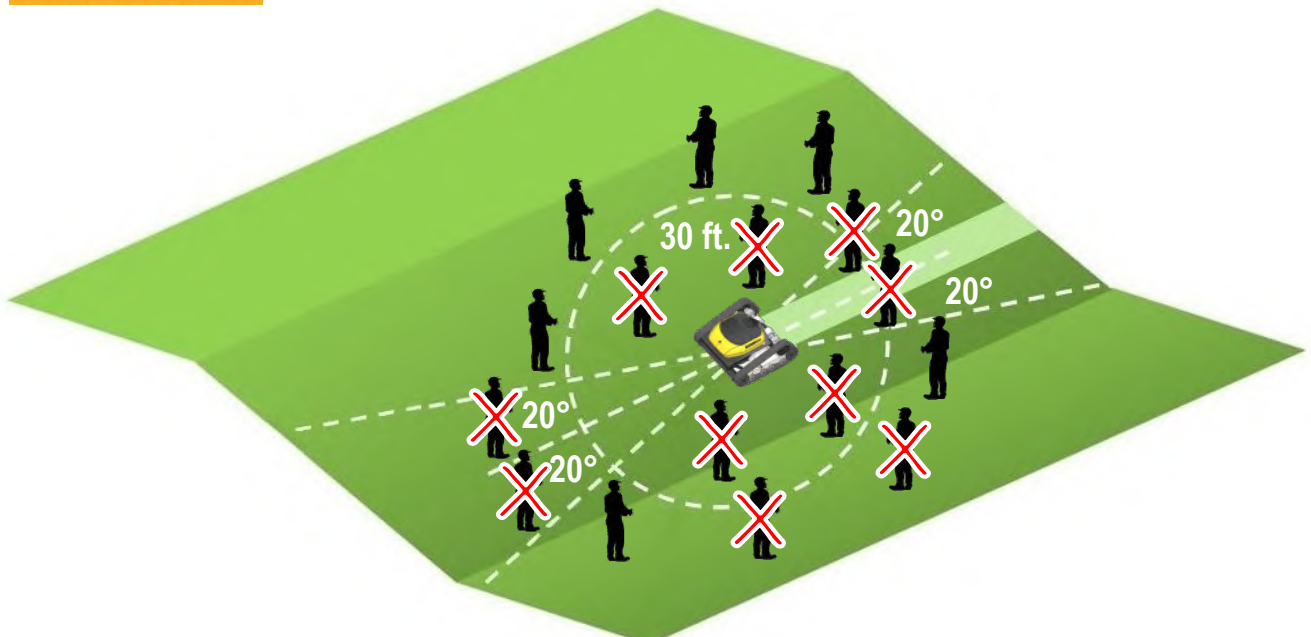

WORK AREA PRECAUTIONS

⚠️ WARNING Work and Work Area Precautions

The following checks should be made prior to operation in the work area;

- Inspect the work area prior to operations; check for and remove foreign bodies such as large stones, metal items, wire, glass etc. which could damage the machinery or may be ejected by the equipment being used. Any immovable object should be visually marked or avoided.
- Ensure the work zone is clear of animals and persons. Never manoeuvre the machine into an area where you can no longer clearly see it working.
- Only work machinery in materials and conditions that are within their designed capability; attempting to work a machine for the wrong task, or beyond its capability, is highly dangerous and risks damage to machine components.
- When working on slopes always start at the bottom and work upwards.
- Never drive the machine down a slope that is in excess of its capability.
- Never operate the machine on slopes or terrain where there is a risk of overturn.
- Review the site and plan the work to abide with safe operating positions.

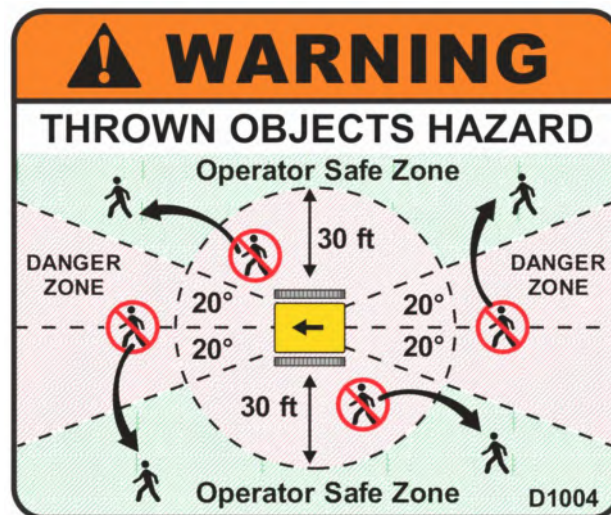

⚠️ CAUTION Never operate the machine in a manner or conditions that place the machine at risk of 'roll-over'

In the event of 'roll-over' the engine must be switched off immediately and the machine safely recovered using suitable equipment. Do not attempt to re-start the engine until it has been inspected and checked by a qualified engine technician.

OPERATION

Personal Protection Equipment (PPE)

Operators must wear suitable safety gear when operating and/or maintaining this machine.



Recommended Safety Gear

- Safety Gloves
- Safety Boots
- Eye Protection
- Protective Overalls
- Safety Helmet
- Ear Defenders
- Dust Mask
- Shin/Knee Protection

Work Lighting Conditions



⚠ WARNING

Never operate the machine in poor lighting conditions.

Only work in good lighting conditions; you must have a clear view of the machine and the entire work area at all times. If necessary use suitable artificial lighting that complies with local rules and regulations.

Fire Hazard



⚠ WARNING

Do not smoke near the machine.

Fuels, oils and lubricants are flammable; keep naked flames away from the machine at all times.

Track Protection

In certain driving conditions or circumstances the machine is at an increased risk of track damage and/or losing a track during manoeuvres; the following advice should be observed to avoid or reduce this risk.

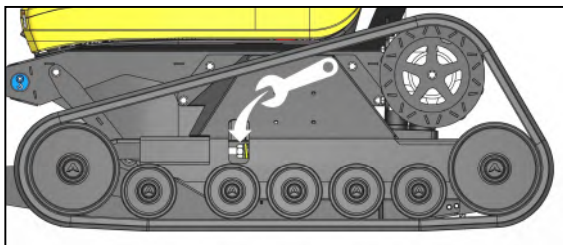

Keep tracks correctly tensioned at all times.

Incorrect track tension increases the risk of track damage or losing a track.



⚠ CAUTION

Do not move along the edge of a slope, or on uneven ground, with one track in the horizontal position and the other inclined or partially raised when machine is inclined in excess of 10°.

To avoid risk of track damage, always proceed with both tracks travelling on the same horizontal plane.

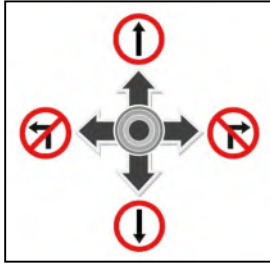
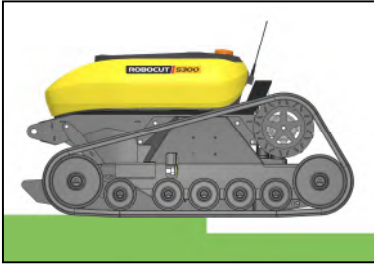

⚠ CAUTION

Do not change direction whilst moving on kerbs, rocks, or surfaces with considerable differences in height (*more than 20cm*); in these instances move perpendicular to the obstacles.

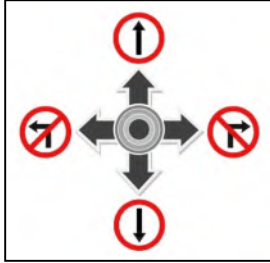
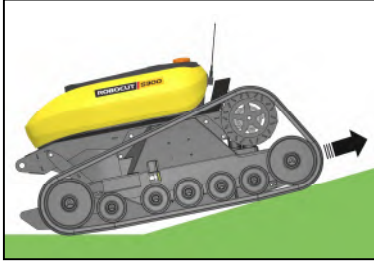

⚠ CAUTION

When reversing uphill, do not steer when transferring from the level surface to the slope; if unavoidable turning manoeuvres should be performed gradually.

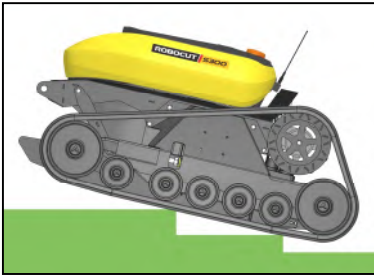

⚠ CAUTION

When the machine manoeuvres over an obstacle, a space is created between the bearing rollers and the track - this can cause the track to come off its seat. The same situation can occur in reverse when a space is created between bearing roller, idler roller, and track.

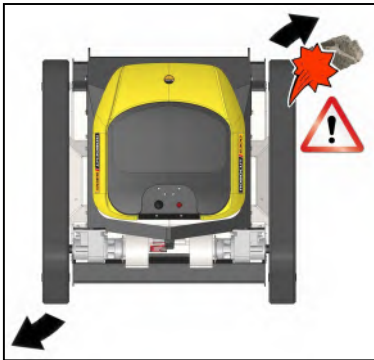

⚠ CAUTION

If the machines changes direction, and the track cannot move sideways due to the presence of an obstacle, there is a risk that the track can be damaged or come of its seat; wherever possible avoid turning the machine if it is against an obstacle, if unavoidable, make manoeuvres slowly and gradually until the machine is clear of the object.

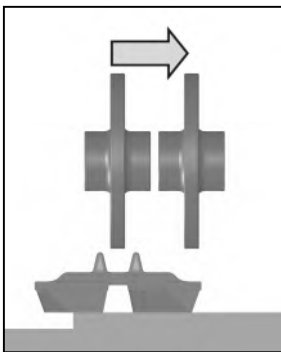

⚠ CAUTION

If the machine moves in reverse in these conditions there is risk of the track coming off its seat.

Generic image used for example purpose.

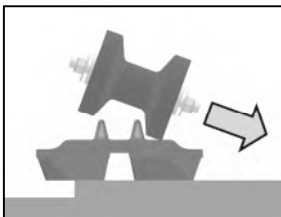

⚠ CAUTION

If the machine is steered in these conditions the track will come off its seat

Generic image used for example purpose.

BRAKES

Machine movement is controlled by electric track motors which drive the machine when they receive electrical power from the generator, motion is stopped by 'short-circuiting' the motors which generates a braking effect to halt the machine.

If the engine is switched off, or cuts-out for any reason, the motors 'lock-out' to hold the machine; if the machine is facing up or down a slope it may not bring the machine to a complete standstill, but it will greatly reduce roll-away speed allowing the machine to 'creep' safely to the bottom of the gradient.

It is important that the machine is never parked-up or left unattended a slope, if the machine needs to be stopped on a slope for any reason it should be positioned across the gradient, and if necessary chocked front and rear to ensure it cannot move under its own weight. Chock Kits (Part No. 4009362) are available as an optional extra if required.

⚠ WARNING Never stand, or allow others to stand, downhill of the machine when it is located on a slope.

Emergency Towing

In a recovery situation that necessitates the machine being towed by another vehicle, the three power cables to each track motor must first be disconnected.

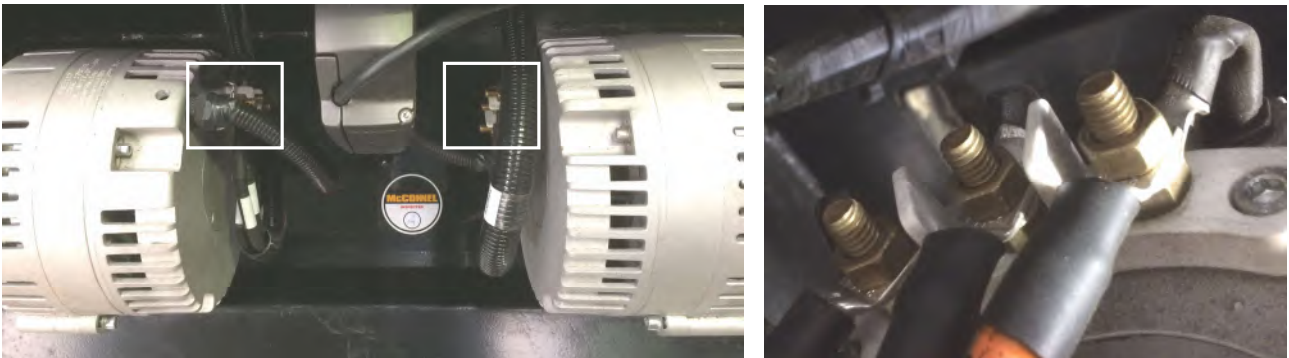

Location of track motor power cables: the 3 power cables on each motor must be disconnected for towing.

Towing of the machine should only be performed in an emergency situation. A rigid towing bar or frame should be used connected to lift point(s) on the front of the machine; never attempt to use chains or ropes to tow the machine.

If it is deemed necessary to tow the machine, distance towed and towing speed should be kept to an absolute minimum.

⚠ CAUTION Never start or run the engine with track motor power cables disconnected.

Parking the Machine

When not in use the machine must always be parked on a firm level site with the main power switched off. When leaving the machine unattended or for long-term storage the machine should be 'chocked' front and rear to avoid risk of accidental movement.

The remote-control unit should be stored in a different location to protect the machine from use by unauthorised persons.

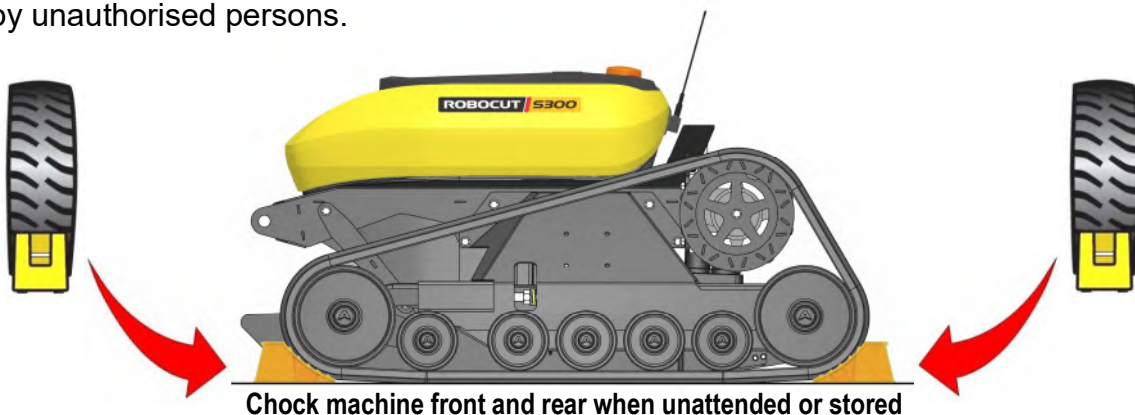

FUEL

Fuel Type: standard unleaded motor vehicle petrol, up to and including 10% Ethanol.

Fuel Capacity: 10 litres.

Only refuel the machine by exchanging the red primary fuel tank; a spare primary fuel tank is supplied with the machine for this purpose.

Swapping out the primary fuel tank must be performed on a level well-ventilated site away from sources of sparks, flames or heat. Machines power must always be SHUT-OFF (machine E-Stop activated) during this procedure.

NEVER attempt to refill a primary fuel tank in situ on the machine.

⚠ DANGER Exchanging fuel tanks must only be performed with engine off and in a cooled down condition - never swap the tanks whilst the engine is hot.

It is advisable to ensure the primary fuel tank mounted on the machine is full at the start of the working day when the engine is cold.

If fuel tank exchange is required during work; always switch the engine off and allow the engine and exhaust to cool down to a safe temperature before swapping out the primary tank.

When fuel lines are removed for exchanging tanks, a small amount of fuel may continue to drip from the lines. Remove lines slowly from the fuel tank. Do not place fuel line ends near hot surfaces.

Any transfer of fuel, to or from a tank, should be performed at a safe distance from the machine to reduce the risk of fire; always fit the tank cap when carrying or transporting fuel tanks, even if they are empty.

When replacing the fuel tank on the machine ensure the cap is replaced correctly and all fuel connections are tight. If caps or connections are damaged, they must be replaced before using the machine.

Fixed braces on the underside of the engine cover secure the fuel tanks in position when the cover is closed. Never attempt to operate the machine with the engine cover open or raised.

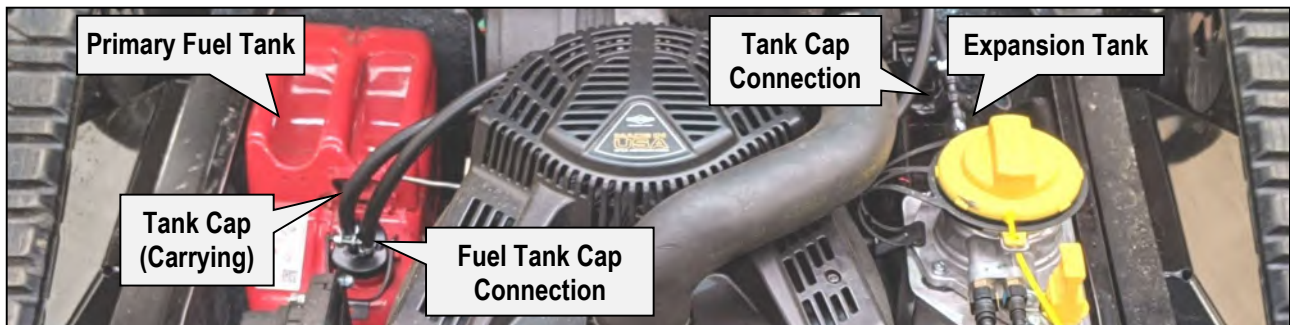

⚠ CAUTION Engine cover must be shut and secured at all times when using machine.

FUEL TANKS

The S300 is equipped for use with 2 fuel tanks; a removable red 'primary' fuel tank located on the right-hand side of the engine and a semi-removable black 'expansion' tank' located on the left-hand side of the engine.

An additional red fuel tank is also supplied with the machine which serves as a swappable 'primary' fuel tank for quick and easy re-fuelling during operations.

Fuel Tank (Red)

The 'primary' fuel tank is for the storage of fuel for supply to the engine.

Fuel tank capacity = **10 litres**.

Fuel Expansion Tank (Black)

The fuel expansion tank is a storage vessel for the overflow of expanded fuel; **it is not** an additional fuel tank for increased fuel capacity. Fuel **must not** be manually added to this expansion tank.



Fuel Expansion System

During normal operations, increases in ambient temperature within the engine compartment will cause fuel in the 'primary' tank to expand - when this occurs any additional volume of fuel that cannot be retained within the primary tank will temporarily transfer to the expansion tank; this excess fuel will automatically syphon back to the primary tank as and when fuel level reduces through use and/or a reduction in ambient temperature.

This action occurs to a greater extent with a high fuel level and is designed to restrict excess fuel from being fed to the engine via the evaporation line; this would result in the engine burning an overly rich fuel mixture that would be evident by excessive black smoke from the exhaust.

It may be found that a certain amount of accumulated fuel remains in the expansion tank even when the system is cold; this should be checked and monitored at the start of each day before using the machine. If the expansion tank is more than half full, the tank should be removed, emptied into a suitable sealed container, and replaced back on the machine.

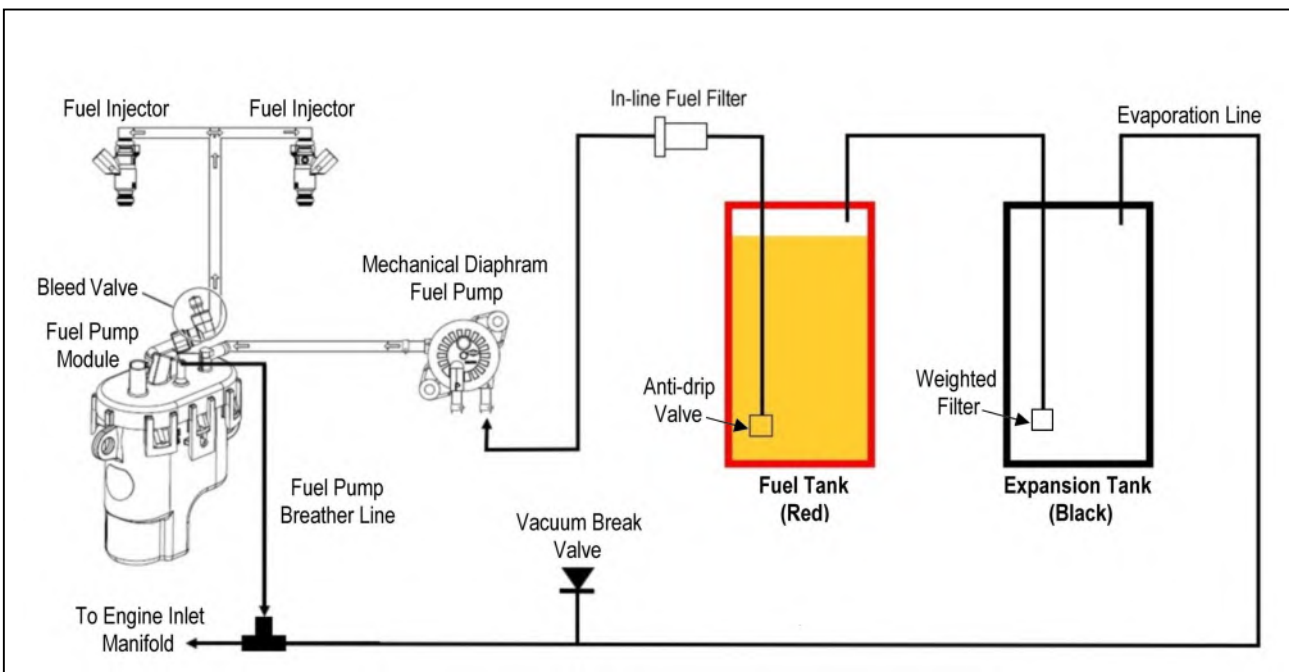

Refuelling

Refuelling the machine is by primary fuel tank exchange. *See previous page for details.*

MAINTENANCE

⚠ WARNING

Checks, maintenance, and service tasks must only be performed with the machine parked on a firm level site.

⚠ WARNING

Never attempt to work on any machine that it not safely supported and chocked. Only use suitable equipment for the task that is fully capable of supporting the machines entire weight.

⚠ WARNING

Never attempt to work under a machine that is suspended on lifting equipment; the machine must be in a fixed position and safely supported from below at all times.

⚠ WARNING

Machine must be switched off and the remote-control starter key removed before attempting to inspect or work on any components under the machine.

ENGINE OIL

Oil Capacity & Type

6.0 litres (10.56 pints) 5w40 engine oil.

Engine Oil Level

Check engine oil level before each start-up and after every 8 hours of operation.

Oil level must be checked with the machine parked on level ground and the dipstick fully inserted; level is correct when it is between the 'Min' and 'Max' marks on the dipstick.

If the level is below the 'Min' mark, oil must be added.

Do not overfill, the oil level must not exceed the 'Max' mark on dipstick.

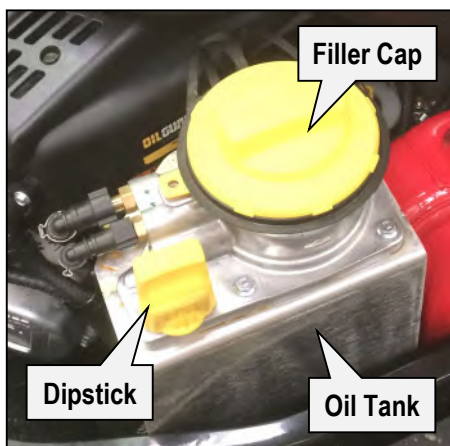

Oil & Filter Change

Engine oil and filter must be changed every **500 hours** or annually, *whichever occurs first*.

Access to the filter is by removal of the oil filler cap; with the cap removed rotate the filter 1/4 turn anti-clockwise to permit removal. An oil syphon pump is required to drain the oil.

Clean the oil tank area thoroughly before removing the filler cap to avoid the risk of dirt, dust, or other contaminants entering the tank.

Oil Filter : Part No. 4009205

AIR FILTER

Air Filters



Tools required; no tools are needed to access filter cartridges.

Air filters should be checked daily and cleaned on a regular basis. Filter cartridges must be replaced at the specified time periods stated in the service schedule.

Filter Cartridge Removal

The machine uses 2 filters cartridges, a primary filter and secondary filter; these are located in the filter housing at the rear of the engine.

Access to the cartridges requires removal of the filter housing end cap which is secured with 2 retaining clips.

Both cartridges are 'push fitted' in the filter housing and removal is by pulling them firmly outwards. The outer cartridge is the primary filter and the inner one the secondary filter.



Air Filter Housing

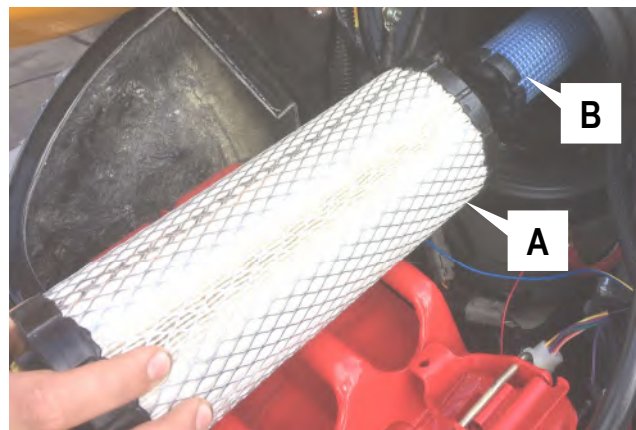

A) Primary Filter B) Secondary Filter

Filter Cartridge Cleaning

Cartridges should be cleaned using compressed air and a soft brush to remove dust build-up and contaminants; respiratory protection should be worn when performing this task.

Clean the inside of the filter housing before replacing cartridges; ensure both cartridges are correctly seated in the housing before replacing the end cap.

The primary air filter should be **cleaned every 100 hours** and **replaced every 500 hours** or annually, *whichever occurs first*. The secondary air filter should be replaced with every 3rd change of the primary air filter.

Primary Filter : Part No. 4009086

Secondary Filter : Part No. 4009087

ROTORS & BLADES

The machine has two belt-driven rotors equipped with sets of opposing blades mounted on a blade carrier; blade sets comprises of an updraft blade and a top cut blade. The 'fast-stop' rotors, which are driven by the engine via an electromagnetic clutch, are mounted on the machine in a staggered configuration to provide overlapped cutting.

Rotors

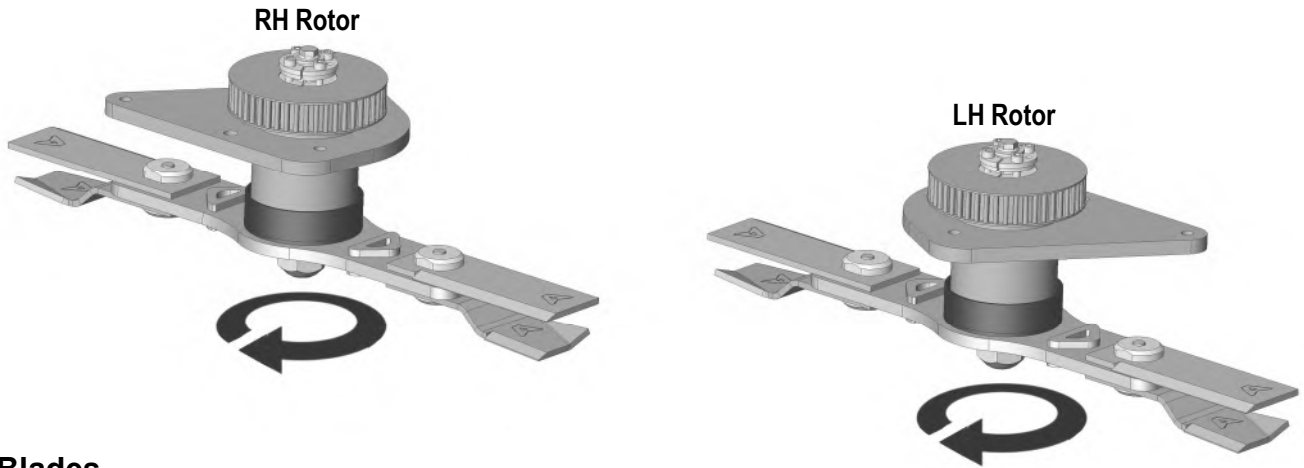

Blades

⚠ WARNING Engine must be switched off and remote-control starter key removed before inspecting or working under the machine.

⚠ WARNING Protective gloves must be worn when inspecting rotors and blades.

Rotors and blades should be inspected on a daily basis for signs of wear or damage; excessively worn or damaged blades must be replaced before using the machine.

Blade Replacement

When fitting new blades they must be replaced in opposing matched pairs to ensure the rotor remains balanced. Blades must only be mounted as shown in arrangement below. When replacing blades new blade screws should also be fitted and secured with a thread-locking adhesive (Loctite 242 or equivalent).



Tools required; 8mm hex key, 36mm spanner.

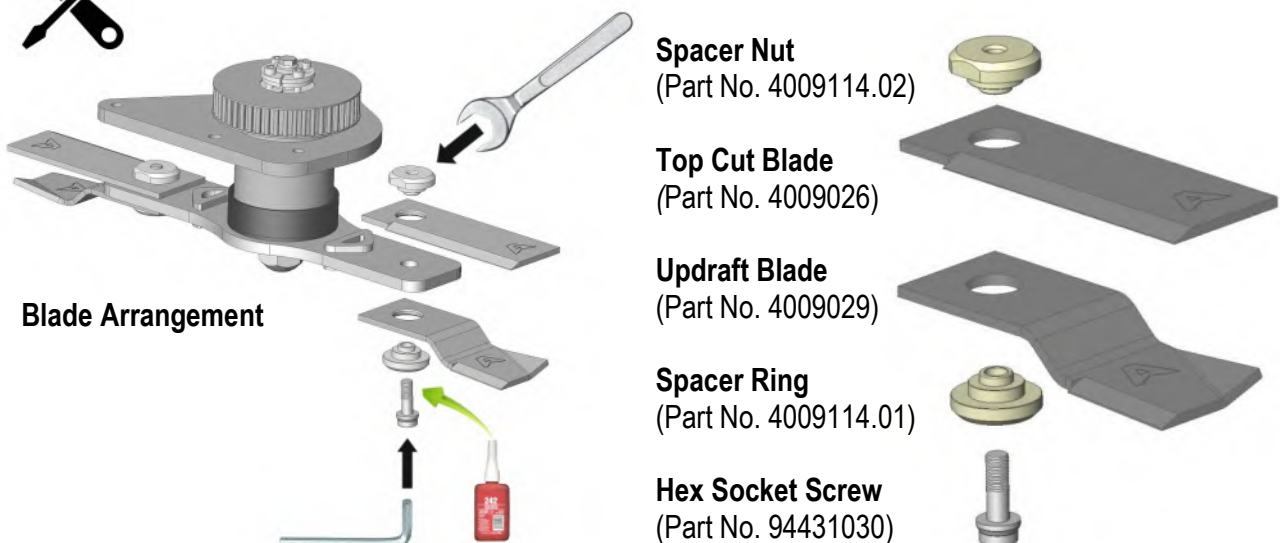

⚠ CAUTION Blades must only be mounted as shown in the arrangement above.

BELTS

The information on this page relates to machines prior to 2023 that use V-belts to drive the rotors and the generator.

See following page for machines 2023 onwards.

Access to Belts

Access to the belts for checking and/or tensioning is from beneath the machine and requires removal of the cover plate; the plate is secured with 7 bolts.



Tools required;
13mm spanner or socket.

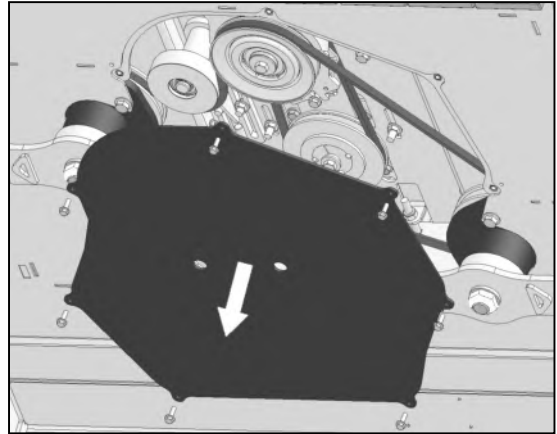

Belts & Pulley's – Identification (Builds ► 2023)

- A. RH Rotor Pulley
- B. LH Rotor Pulley
- C. Generator Pulley
- D. Engine Drive Pulley
- E. Tensioner Wheel
- F. Belt Tension Adjuster
- G. Rotor Drive V-belt (P/N: 4009334)
- H. Generator Drive V-belt (P/N: 4009273)

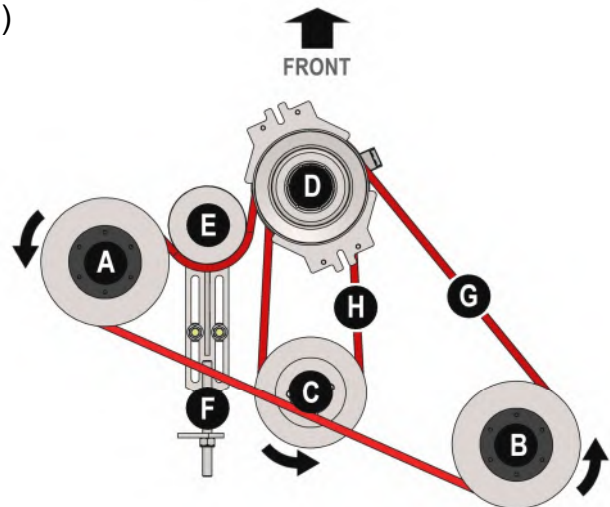

Belt and Pulley layout (viewed from below)

Belt Tension

Belt tension should be checked every **25 hours**.

The correct tension for the belts is **15-20mm** deflection using thumb pressure; this should be measured at the mid-point position between pulleys on the longest belt run section.

For greater accuracy the belt tensions can be checked using an optical or audio frequency meter, the required frequencies are as follows;

For rotor belt the frequency should be **60Hz** on the short span or **90Hz** on the long span.

For generator belt the frequency should be **180Hz** measured on either span.

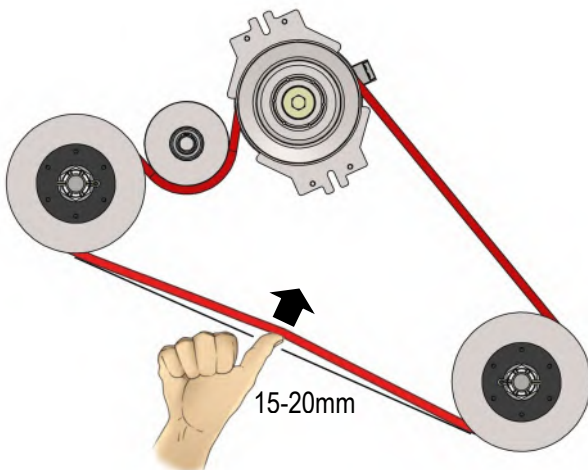

Rotor Drive Belt Tension

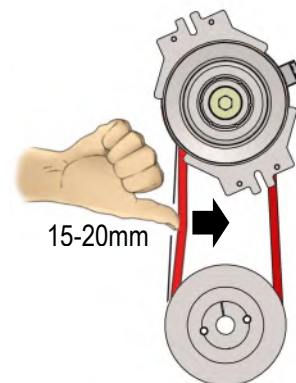

Generator Belt Tension

When checking the tension of belts they should be inspected for signs of wear or damage; belts that are excessively worn or damaged must be replaced before using the machine.

The information on this page relates to machines 2023 onwards that use a toothed belt to drive the rotor and V-belt to drive the generator.

Access to Belts

Access to the belts for checking and/or tensioning is from beneath the machine and requires removal of the cover plate; the plate is secured with 7 bolts.



Tools required;
13mm spanner or socket.

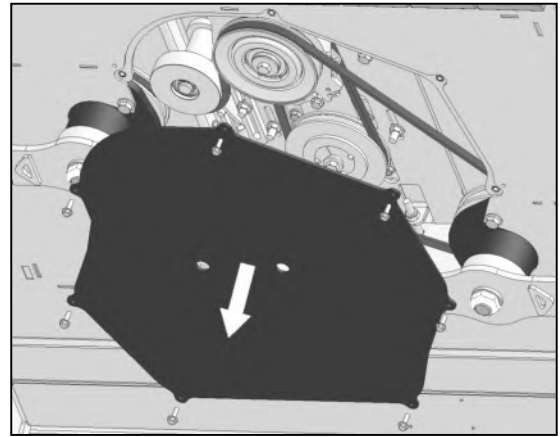

Belts & Pulley's – Identification (Builds 2023▶)

- A. RH Rotor Pulley
- B. LH Rotor Pulley
- C. Generator Pulley
- D. Engine Drive Pulley
- E. Tensioner Wheel
- F. Belt Tension Adjuster
- G. Rotor Drive Toothed Belt (P/N: 4009396)
- H. Generator Drive V-belt (P/N: 4009273)

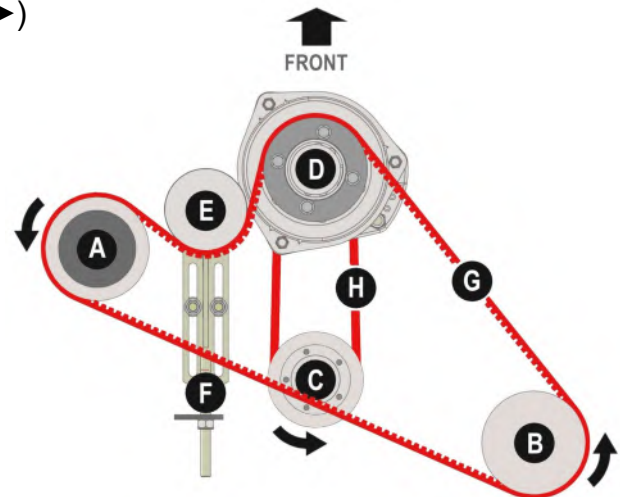

Belt and Pulley layout (viewed from below)

Belt Tension

Belt tension should be checked every **25 hours**.

The correct tension for the **toothed rotor belt** is **8-12mm** deflection using thumb pressure; this should be measured at the mid-point position between pulleys on the longest belt run section. The correct tension for the **generator belt** is **15-20mm** deflection on either span.

For greater accuracy the belt tensions can be checked using an optical or audio frequency meter, the required frequencies are as follows;

For toothed rotor belt the frequency should be **50-55Hz** measured on the **short span**.

For generator belt the frequency should be **180Hz** measured on either span.

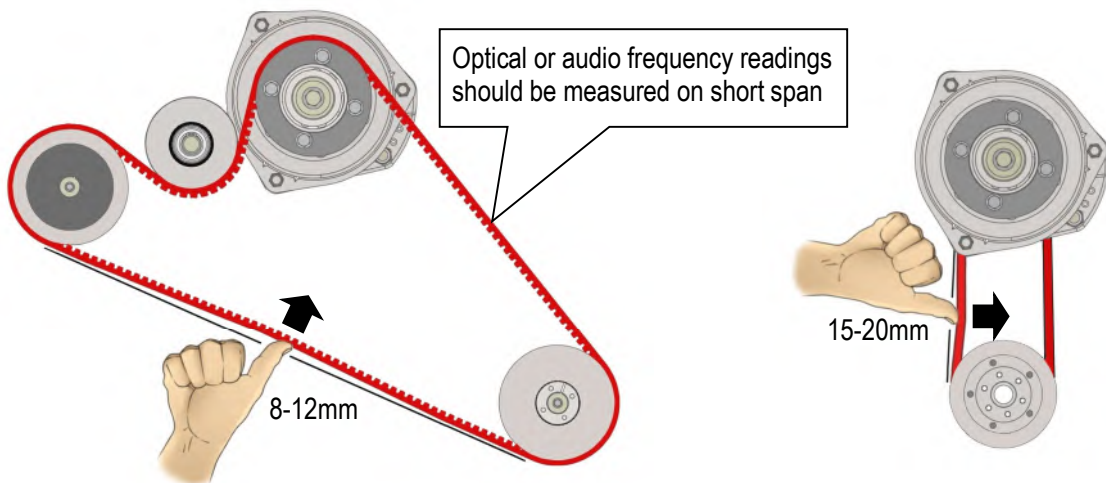

Rotor Drive Toothed Belt Tension

Generator V-Belt Tension

When checking the tension of belts they should be inspected for signs of wear or damage; belts that are excessively worn or damaged must be replaced before using the machine.

Rotor Belt – Tension Adjustment



Tools required; 17mm & 19mm spanners.

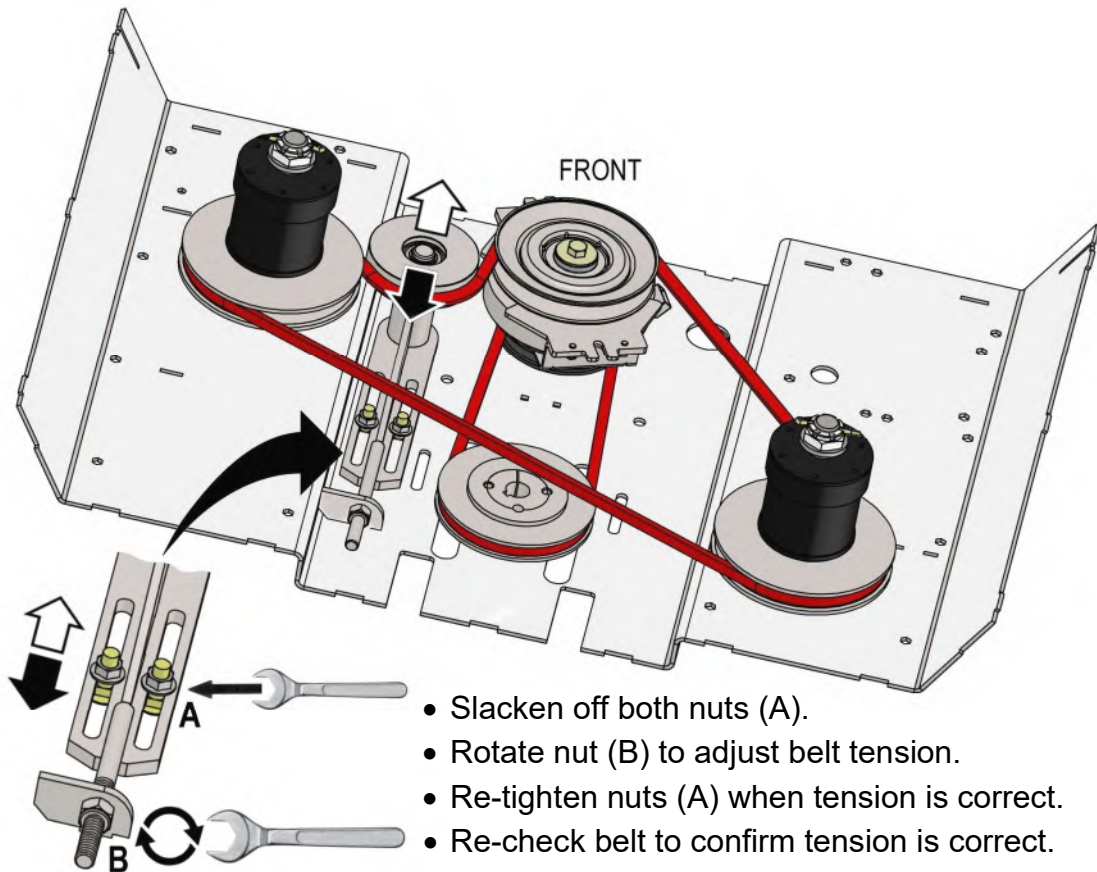

- Slacken off both nuts (A).
- Rotate nut (B) to adjust belt tension.
- Re-tighten nuts (A) when tension is correct.
- Re-check belt to confirm tension is correct.

Generator Belt – Tension Adjustment

- Slacken off both nuts (A).
- Rotate nuts (B) equally to adjust belt tension.
- Re-tighten nuts (A) when tension is correct.
- Re-check belt to confirm tension is correct.

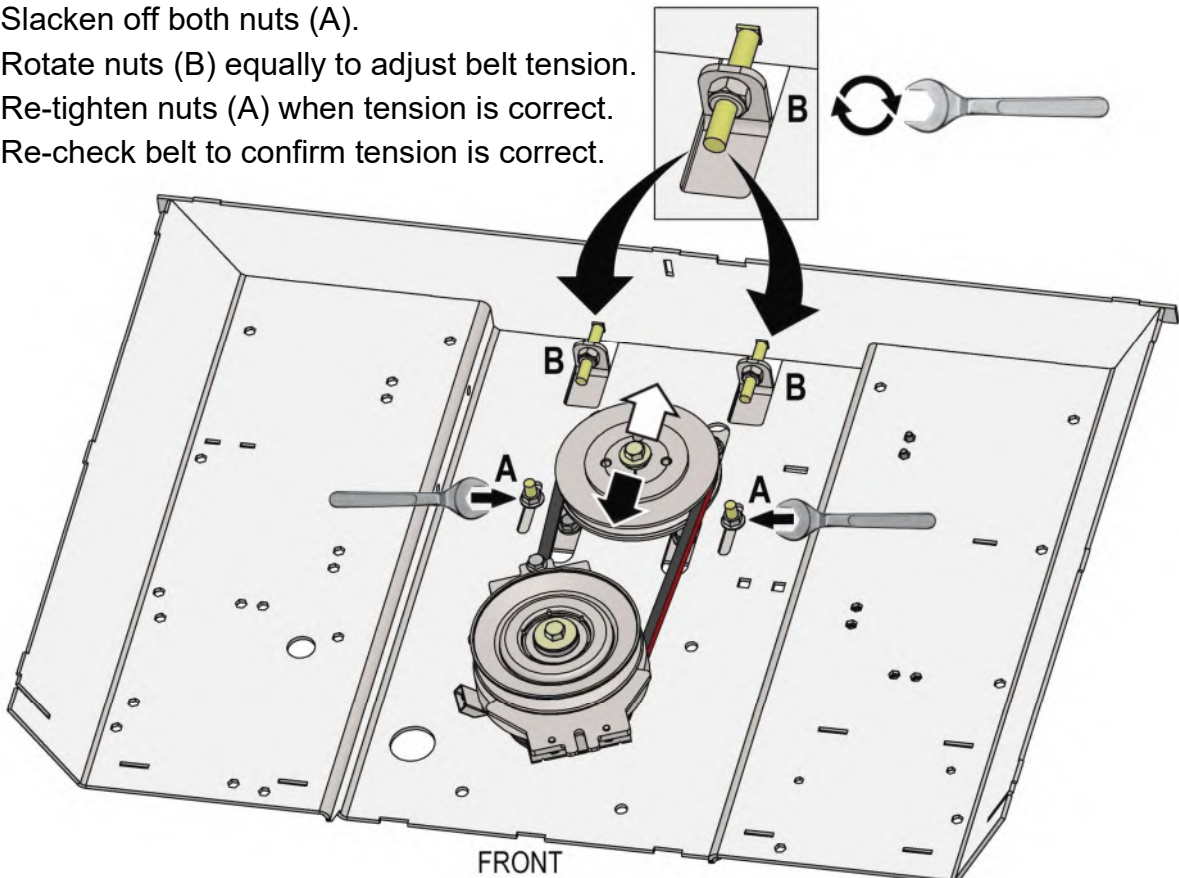

TRACKS

Track Replacement

Tracks must be replaced when the treads are excessively worn, or sooner if there are large cuts, cracks, or damage that could affect their safe use.

⚠ WARNING

Never attempt to work on any machine that is not safely supported and chocked. Only use suitable equipment for the task that is fully capable of supporting the machine's entire weight.

⚠ WARNING

Ensure suitable safety gear is worn at all times when performing maintenance tasks. Beware, there is 'pinch risk' when working on track components – *keep hands clear of risk areas*.



Tools required; 22mm, 24mm & 36mm spanners, pry bar.

Track Removal Procedure

Raise machine off the ground to a height of approximately 30-40cm; *ensure the machine is stable and suitably supported*. Clean undercarriage components and surrounding areas of the machine before removing tracks.

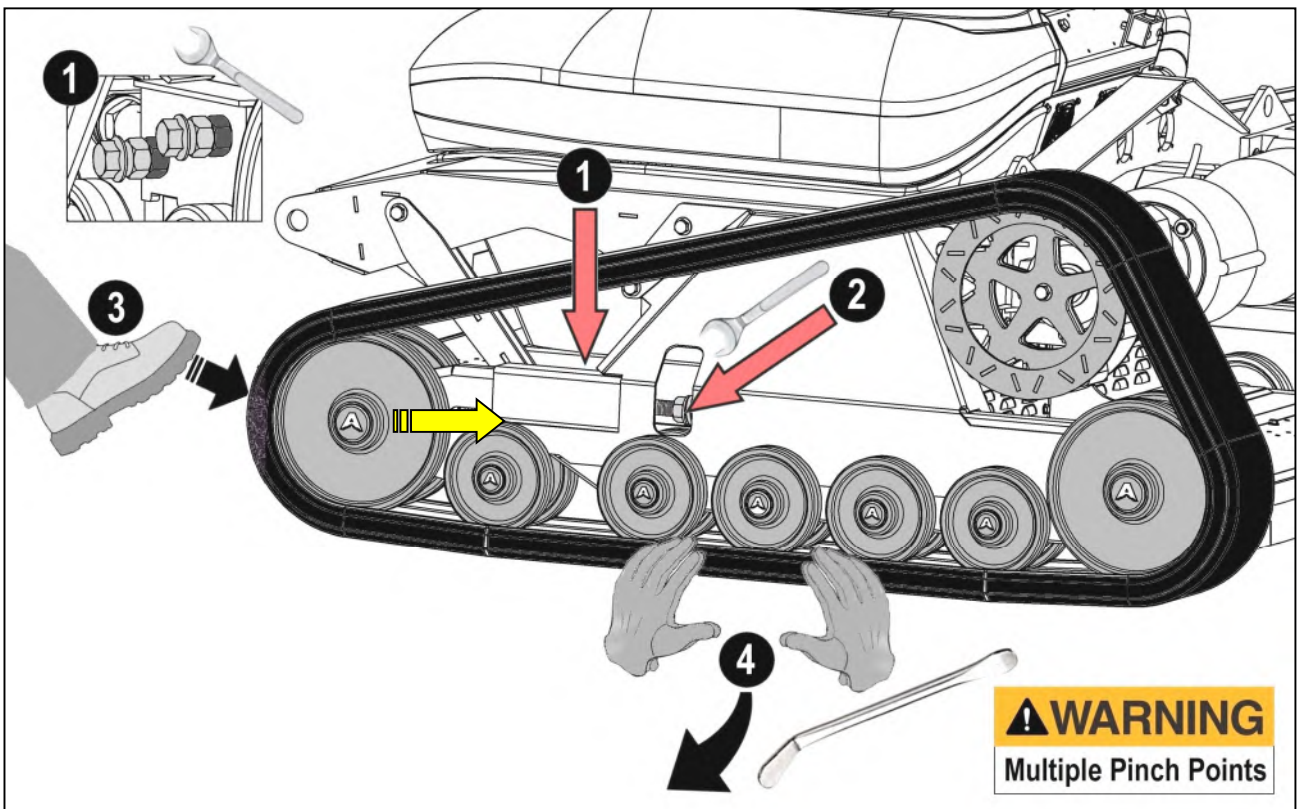

- 1) Slacken off the 24mm clamping bolts (x2) located on the inner face of the landing gear.
- 2) Slacken off the 36mm track tensioner nut to fully release tension.
- 3) Compress tension unit; this can be done by using your foot to push track and idler roller rearwards.
- 4) Draw the track downwards and outwards at its mid-point position on the lower run to pull it off its seating, carefully lever between the track and the idler roller until track is free enough to be removed. Keep hands and fingers clear of the rollers to avoid injury!!

Tracks are heavy items; keep clear of the track as it falls to the ground.

Track Fitting Procedure

Installation of a track is basically a reversal of the removal procedure previously described. When the track has been installed it must be correctly tensioned to the specific setting detailed below; when the tension has been set, secure the tensioner by re-tighten the 24mm clamping bolts (x2) located on the inner landing gear.

Track Tension Setting

Track tension is set using heavy-duty compression springs. To ensure correct tension is applied, slacken off the clamping bolts and locking nuts before turning tensioning nut to compress the spring; correct tension is achieved when tensioner washer is in contact with the folded steel plate that houses the spring (*refer to the image below*). When track tension has been correctly set, re-tighten clamping bolts and locking nuts.

Track Tensioner

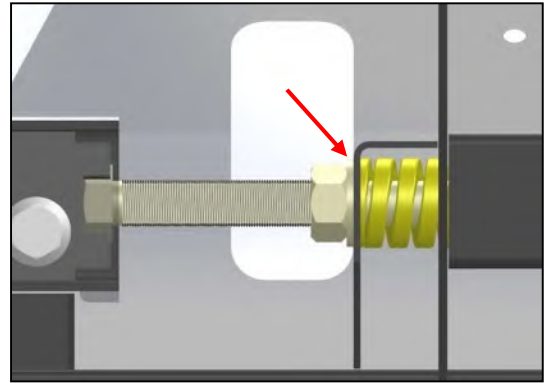
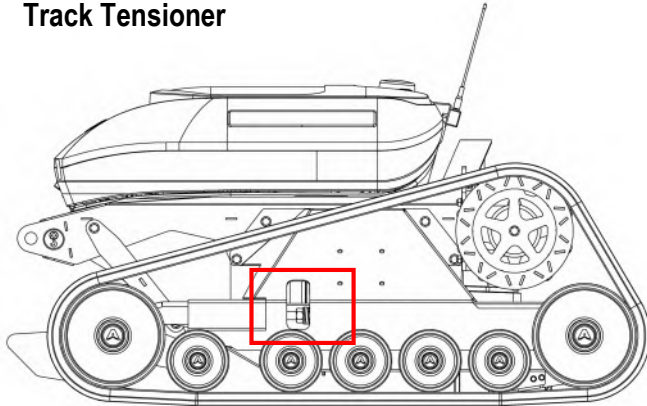

Tighten tensioner nut until washer is in direct contact with the spring housing plate.

NOTE: Tensioner spring is not visible externally, the spring housing plate is located directly in line with the rear edge of the access hole.

Track Tension Check

Tracks should be re-tensioned after an initial 2 hours work with a new machine and on an annual basis thereafter.

If the machine is placed into long-term storage it is suggested that the tensioners be 'slackened off' to relax the rubber tracks; tracks must be re-tensioned before next use.

INVERTER COOLING FANS

Machines are equipped with 2 cooling fans located at the rear of the machine; the function of the fans is to provide additional cooling to the heatsinks for the track inverter by drawing air into the rear of the engine compartment.

During normal operations, the area between the fan mounting plate and the heatsink can accumulate a build-up of cutting debris and dust that can reduce the effectiveness of the fans, or in extreme cases block air flow. To ensure maximum cooling, this area should be inspected and cleaned on a monthly basis as part of a regular maintenance procedure or sooner if inverter overheating is experienced.

Cooling Fan Cleaning



Tools Required: 10mm spanner or socket, soft brush.

Cleaning Procedure

Remove the M6 bolts (x4) that secure the fan mounting plate to the rear of the chassis and draw the mounting plate rearwards, *see photo opposite*. Care should be taken to avoid damaging the fan unit wiring looms.

With the mounting plate clear of the chassis the area behind the fans will be exposed allowing access to remove any build-up of debris. The fans should be carefully cleaned whilst exposed using a soft bristle brush to remove any build-up of dust. When the area has been thoroughly cleaned the mounting plate can be replaced and secured with the 4 bolts previously removed.

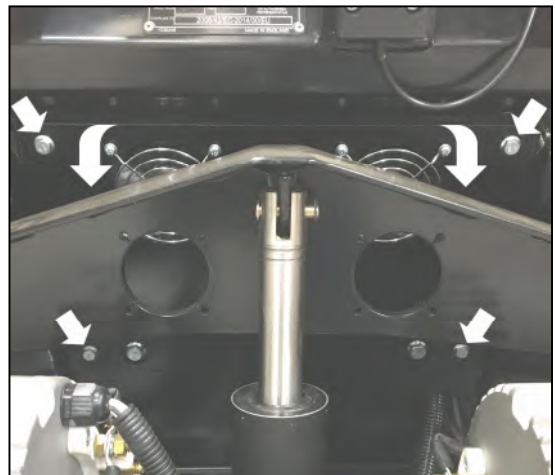

REMOTE BATTERY CHARGING

The machine's remote-control unit is supplied with a spare battery for use as a reserve. A charging station for the control unit reserve battery is built-in to the receiver unit located within the engine compartment.

For uninterrupted operation, the reserve battery can be stored in the charging station; this will ensure it remains fully charged and ready for use.



The charging station only provides power to the battery whilst the engine is running; the charger will automatically 'cut-out' when the battery reaches its fully charged state.

INLINE FUEL FILTER

An inline fuel filter (4009265) is installed at a midway point on the fuel feed hose; the filter should be replaced at the intervals specified in the service schedule.



Tools Required:
Flat end screwdriver



Filter Removal Procedure

The filter is secured to hoses with 2 jubilee clips, loosen clips to permit removal of filter. Replace the filter unit ensuring it is fitted in the correct orientation and re-secure with clips.

Note: during this procedure the fuel lines should be checked for signs of cracks or leaks and replaced if necessary.

Start engine and check filter to hose connections are leak-free before using the machine.

EMISSION CONTROL SYSTEM

For emission control systems please use an annual maintenance schedule to check the condition of all components within the certified components; if any items show signs of being defective, worn, or damaged, they should be replaced immediately.

Emission control components:

- Red Primary Fuel Can (4009058)
- Black Expansion Fuel Tank (4009058B)
- Fuel Hose Kit (4009344)
 - Tank to Filter Hose (4009061.01)
 - Filter to Engine Hose (4009061.02)
 - Fuel Tank to Expansion Tank Hose (4009061.03)
 - Tank to Breather Hose (4009061.04)
- Fuel Can Adaptor (4009062)
- Mesh Pipe Filter (4009064)
- Inline Fuel Filter (4009265)
- Seal (4009085)
- Engine (4009201)
- Exhaust (4009202)
- Valve (4009259)

The minimum replacement interval for fuel cap gaskets (4009085) is every 3 years; this will be required sooner if gaskets show signs of damage or perishing. We recommend that these gaskets are replaced annually during a service.

Please refer to the engine manufacturer's documentation with regard to engine and exhaust system.

FUSES & RELAYS

Fuse & Relay Identification

PN: 4009074	
R1 Ignition	20A
R2 Engine	50A
R3 Start	20A
R4 Clutch	20A
R5 Interlock	20A
R7 Motors	20A
R8 Throttle	8A
F2 Engine	10A
F3 Start	10A
F4 Clutch	10A
F5 Receiver	2A
F6 PLC / Fans	5A
F7 Deck Actuator	15A
F8 Inclinator	2A
F9 Motors	10A
F10 Trim / Beacon	5A

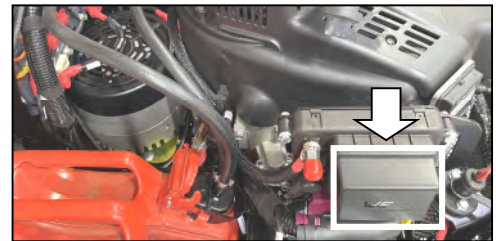

Engine Fuses & Relay Identification

Main Power Relay orientation: PIN 87 to Fuse Block Cavity 3 and PIN 30 to Fuse Block Cavity 10.

CLEANING & STORAGE

Cleaning the Machine

It is recommended that the machine is cleaned on a daily basis using an air hose and/or soft brush to remove dust and debris. If necessary, carefully wipe down external surfaces using a damp cloth. Do not allow water to come into contact with electrical components.



DO NOT use a pressure washer or hose pipe to clean the machine.

Machine Storage

Store the machine in a safe clean environment where it is protected from the elements. The remote-control unit should be kept in a separate secure location to avoid risk of unauthorised use. Ensure E-Stops are activated and Isolator Switch is in the OFF position during storage.

TROUBLESHOOTING

PROBLEM	CAUSE	REMEDY
Rotors not turning	Rotor belt loose Rotor belt damaged Blade blocked RPM reading zero Clutch fuse blown Clutch relay defective Clutch fault or failure Soft start relay defective	Re-tension rotor belt Replace rotor belt Clear blockage Increase RPM Replace fuse Replace relay Check wiring / replace clutch Replace relay
Tracks do not operate	Engine speed (RPM) at idle Tracks blocked Track motor wiring defective Generator belt missing / loose Generator wiring defective Track motor brushes worn Generator brushes worn Inverter light flashing Overheated track inverter(s)	Increase engine RPM Clear track blockage Check wiring to motors Replace and/or tighten belt Check wiring to generator Check / replace brushes Check / replace brushes Increase RPM Remove any debris behind heatsink fans Replace faulty heatsink fan
Tracks running too slow	Tracks hampered by residue or foreign objects Track motor brushes worn Generator belt missing Generator brushes worn	Remove residue or foreign objects from tracks Check / replace brushes Replace belt Check / replace brushes
Deck will not raise / lower	Foreign object on / under deck Linear actuator wiring fault Linear actuator defective Remote switch defective Deck actuator defective	Remove foreign objects Check / replace wiring Repair or replace actuator Test and replace if defective Test and replace if defective
Radio signal loss	Excessive distance between remote-control and machine Signal interference caused by powerlines or electric sources Antenna damaged or defective Antenna wiring damaged/faulty	Reduce operating distance - operate in machine range Avoid operating near sources of electrical interference Replace antenna Replace antenna wiring
Excessive vibration	Fixings loose or missing Rotor imbalance due to damage or missing blades Worn or damaged bearing	Tighten / replace fixings Check rotors for damaged components or missing blades Replace defective bearing

PROBLEM	CAUSE	REMEDY
Electric starter not working	Remote-control not 'paired' Flat battery Starter motor or solenoid switch defective Ignition switch defective Remote starter switch fault Wiring or control fault	Pair remote-control to machine Charge or replace battery Test starter motor / solenoid switch and replace if required Replace ignition switch Replace remote-control unit Check wiring and controls
Engine fails to start	Fuel tank empty Fuel line clogged Spark plug cap not connected Defective spark plug Engine flooded with fuel Air filter dirty / contaminated Air infiltration due to loose carburettor or intake pipe Defective wiring	Replenish fuel Clean fuel line Re-fit spark plug cap Replace spark plug Clean and dry spark plugs Clean / replace filter cartridges Check / tighten carburettor and intake pipe fixings Repair / replace wiring
Engine misfire	Ignition cable(s) loose Fuel line clogged / wrong fuel Trapped fuel line Water or dirt in fuel line Blocked fuel filter Air filter dirty / contaminated Carburettor wrongly adjusted Vacuum break valve blocked	Check/tighten ignition cables Clean fuel line / add fresh fuel Check fuel line routing Drain and add fresh clean fuel Replace fuel filter Clean / replace filter cartridges Adjust / tune carburettor Replace vacuum break valve
Engine overheating	Insufficient engine oil Air cooling system restricted Air filter dirty / contaminated Carburettor incorrectly adjusted	Check level and add engine oil Clear restrictions Clean / replace filter cartridges Adjust / tune carburettor
Engine underpowered	Air filter dirty / contaminated Cylinder head leaking Low compression	Clean / replace filter cartridges Torque head / replace gasket Engine inspection required
Belt comes off	Insufficient tension Worn or damaged belt	Re-fit belt and tension correctly Replace belt
Belt noise	Insufficient belt tension Worn or damaged belt	Re-fit belt and tension correctly Replace belt

SERVICE SCHEDULE

Preliminary Maintenance Schedule : New machines.

- Check blade belt tension **every 2 hours** during initial 10 hours of use.

Standard Maintenance Schedule

Maintenance Task / Frequency	10 Hours (Daily)	25 Hours	100 Hour	500 Hour (Annual)	1500 Hour
Check blade bolts are tight	•				
Remove cutting debris build-ups	•				
Check and/or adjust blade belt tension		•			
Check and/or adjust track tension		•			
Clean primary air filter			•		
Change engine oil and filter				•	
Check and/or adjust generator belt tension				•	
Replace fuel filter				•	
Replace primary air filter				•	
Replace neck seals on both jerry cans				•	
Inspect and clean exhaust muffler				•	
Check spark arrestor (replace if required)				•	
Replace spark plugs				•	
Replace secondary air filter					•

Additional Recommended Maintenance Schedule

Maintenance Task / Frequency	10 Hours (Daily)	25 Hours	100 Hour	500 Hour (Annual)	1500 Hour
Check and/or adjust spark plug gap			•		
Check and/or adjust valve clearance				•	

Spark Plug Gap

0.03" / 0.73mm

Valve Clearances

Inlet Valve: 0.004 – 0.006" / 0.10 – 0.15mm

Exhaust Valve: 0.004 – 0.006" / 0.10 – 0.15mm

Engine Oil

SAE 5w40

Service Part	Part No.
Oil Filter	4009205
Primary Air Filter	4009086
Secondary Air Filter	4009087
Fuel Filter	4009265
Jerry Can Neck Seal	4009085

Service Part	Part No.
Spark Plug(s)	4009226
Generator V-belt	4009273
Rotor V-belt (*)	4009334
Rotor Toothed Belt (**)	4009396
(*) Pre-2023 builds / (**) Builds 2023 onwards	



McConnel Limited, Temeside Works, Ludlow, Shropshire SY8 1JL. England.
Telephone: 01584 873131. Facsimile: 01584 876463. www.mcconnel.com