

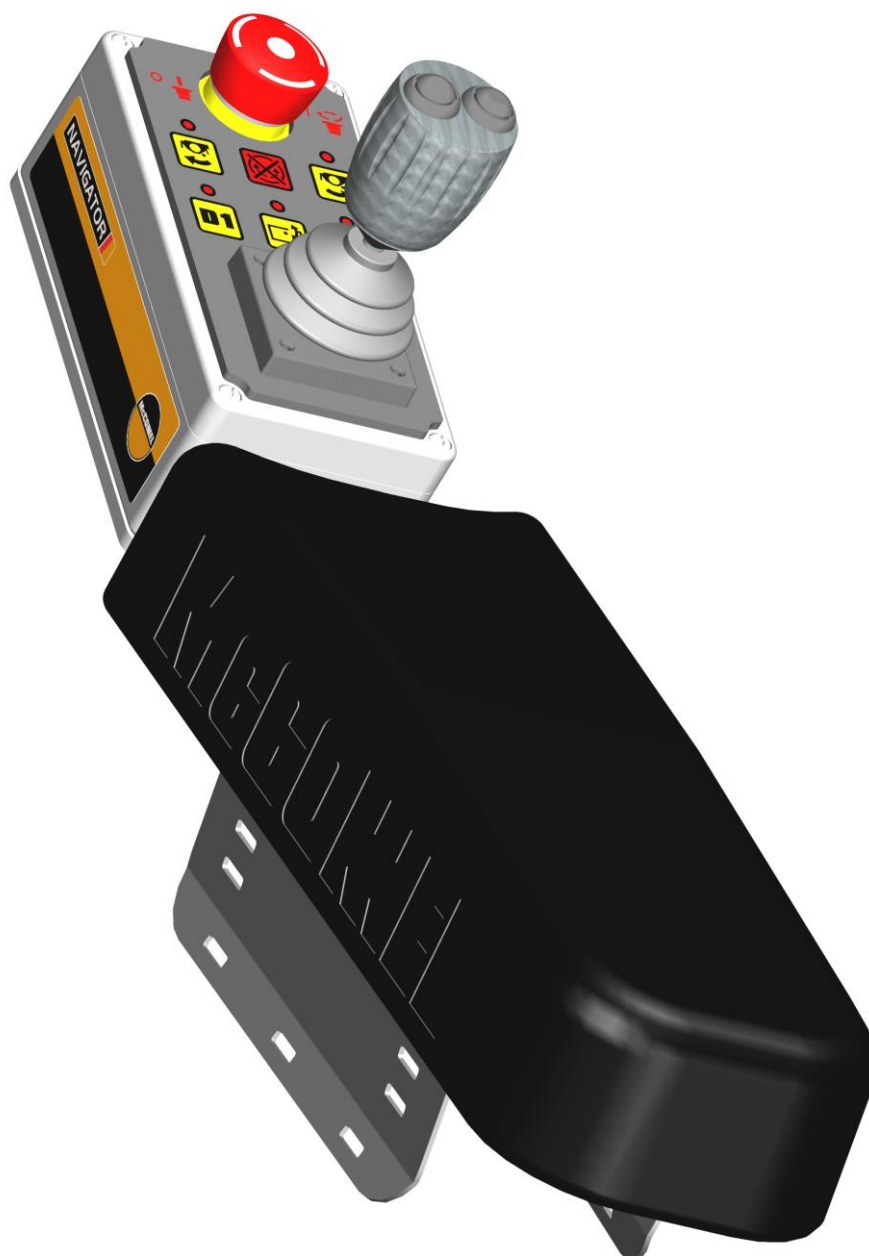

NAVIGATOR CONTROLS

Operation Manual
(VERSI Machines)





For Safety and Performance...

ALWAYS READ THE BOOK FIRST



This manual must be read in conjunction with the machine manual

McCONEl LIMITED

**Temeside Works
Ludlow
Shropshire
England**

**Telephone: +44 (0)1584 873131
www.mccommel.com**

WARRANTY POLICY

WARRANTY REGISTRATION

All machines must be registered, by the selling dealer with McConnel Ltd, before delivery to the end user. On receipt of the goods it is the buyer's responsibility to check that the Verification of Warranty Registration in the Operator's Manual has been completed by the selling dealer.

1. LIMITED WARRANTIES

- 1.01. *All mounted machines supplied by McConnel Ltd are warranted to be free from defects in material and workmanship from the date of sale to the original purchaser for a period of 12 months, unless a different period is specified.*
All Self Propelled Machines supplied by McConnel Ltd are warranted to be free from defects in material and workmanship from the date of sale to the original purchaser for a period of 12 months or 1500 hours. Engine warranty will be specific to the Manufacturer of that unit.
- 1.02. *All spare parts supplied by McConnel Ltd and purchased by the end user are warranted to be free from defects in material and workmanship from the date of sale to the original purchaser for a period of 6 months. All parts warranty claims must be supported by a copy of the failed part invoice to the end user. We cannot consider claims for which sales invoices are not available.*
- 1.03. *The warranty offered by McConnel Ltd is limited to the making good by repair or replacement for the purchaser any part or parts found, upon examination at its factory, to be defective under normal use and service due to defects in material or workmanship. Returned parts must be complete and unexamined. Pack the component(s) carefully so that any transit damage is avoided. All ports on hydraulic items should be drained of oil and securely plugged to prevent seepage and foreign body ingress. Certain other components, electrical items for example, may require particular care when packing to avoid damage in transit.*
- 1.04. *This warranty does not extend to any product from which McConnel Ltd's serial number plate has been removed or altered.*
- 1.05. *The warranty policy is valid for machines registered in line with the terms and conditions detailed and on the basis that the machines do not extend a period of 24 months or greater since their original purchase date, that is the original invoice date from McConnel Limited.*
Machines that are held in stock for more than 24 months cannot be registered for warranty.
- 1.06. *This warranty does not apply to any part of the goods, which has been subjected to improper or abnormal use, negligence, alteration, modification, fitment of non-genuine parts, accident damage, or damage resulting from contact with overhead power lines, damage caused by foreign objects (e.g. stones, iron, material other than vegetation), failure due to lack of maintenance, use of incorrect oil or lubricants, contamination of the oil, or which has served its normal life. This warranty does not apply to any expendable items such as blades, belts, clutch linings, filter elements, flails, flap kits, skids, soil engaging parts, shields, guards, wear pads, pneumatic tyres or tracks.*
- 1.07. *Temporary repairs and consequential loss - i.e. oil, downtime and associated parts are specifically excluded from the warranty.*
- 1.08. *Warranty on hoses is limited to 12 months and does not include hoses which have suffered external damage. Only complete hoses may be returned under warranty, any which have been cut or repaired will be rejected.*
- 1.09. *Machines must be repaired immediately a problem arises. Continued use of the machine after a problem has occurred can result in further component failures, for which McConnel Ltd cannot be held liable, and may have safety implications.*
- 1.10. *If in exceptional circumstances a non McConnel Ltd part is used to effect a repair, warranty reimbursement will be at no more than McConnel Ltd's standard dealer cost for the genuine part.*

- 1.11. *Except as provided herein, no employee, agent, dealer or other person is authorised to give any warranties of any nature on behalf of McConnell Ltd.*
- 1.12. *For machine warranty periods in excess of 12 months the following additional exclusions shall apply:*
 - 1.12.1. *Hoses, exposed pipes and hydraulic tank breathers.*
 - 1.12.2. *Filters.*
 - 1.12.3. *Rubber mountings.*
 - 1.12.4. *External electric wiring.*
 - 1.12.5. *Bearings and seals*
 - 1.12.6. *External Cables, Linkages*
 - 1.12.7. *Loose/Corroded Connections, Light Units, LED's*
 - 1.12.8. *Comfort items such as Operator Seat, Ventilation, Audio Equipment*
- 1.13. *All service work, particularly filter changes, must be carried out in accordance with the manufacturer's service schedule. Failure to comply will invalidate the warranty. In the event of a claim, proof of the service work being carried out may be required.*
- 1.14. *Repeat or additional repairs resulting from incorrect diagnosis or poor quality previous repair work are excluded from warranty.*

NB Warranty cover will be invalid if any non-genuine parts have been fitted or used. Use of non-genuine parts may seriously affect the machine's performance and safety. McConnell Ltd cannot be held responsible for any failures or safety implications that arise due to the use of non-genuine parts.

2. REMEDIES AND PROCEDURES

- 2.01. *The warranty is not effective unless the Selling Dealer registers the machine, via the McConnell web site and confirms the registration to the purchaser by completing the confirmation form in the operator's manual.*
- 2.02. *Any fault must be reported to an authorised McConnell Ltd dealer as soon as it occurs. Continued use of a machine, after a fault has occurred, can result in further component failure for which McConnell Ltd cannot be held liable.*
- 2.03. *Repairs should be undertaken within two days of the failure. Claims submitted for repairs undertaken more than 2 weeks after a failure has occurred, or 2 days after the parts were supplied will be rejected, unless the delay has been authorised by McConnell Ltd. Please note that failure by the customer to release the machine for repair will not be accepted as a reason for delay in repair or submitting warranty claims.*
- 2.04. *All claims must be submitted, by an authorised McConnell Ltd Service Dealer, within 30 days of the date of repair.*
- 2.05. *Following examination of the claim and parts, McConnell Ltd will pay, at their discretion, for any valid claim the invoiced cost of any parts supplied by McConnell Ltd and appropriate labour and mileage allowances if applicable.*
- 2.06. *The submission of a claim is not a guarantee of payment.*
- 2.07. *Any decision reached by McConnell Ltd. is final.*

3. LIMITATION OF LIABILITY

- 3.01. *McConnell Ltd disclaims any express (except as set forth herein) and implied warranties with respect to the goods including, but not limited to, merchantability and fitness for a particular purpose.*
- 3.02. *McConnell Ltd makes no warranty as to the design, capability, capacity or suitability for use of the goods.*
- 3.03. *Except as provided herein, McConnell Ltd shall have no liability or responsibility to the purchaser or any other person or entity with respect to any liability, loss, or damage caused or alleged to be caused directly or indirectly by the goods including, but not limited to, any indirect, special, consequential, or incidental damages resulting from the use or operation of the goods or any breach of this warranty. Notwithstanding the above limitations and warranties, the manufacturer's liability hereunder for damages incurred by the purchaser or others shall not exceed the price of the goods.*
- 3.04. *No action arising out of any claimed breach of this warranty or transactions under this warranty may be brought more than one (1) year after the cause of the action has occurred.*

4. MISCELLANEOUS

- 4.01. McConnel Ltd may waive compliance with any of the terms of this limited warranty, but no waiver of any terms shall be deemed to be a waiver of any other term.*
- 4.02. If any provision of this limited warranty shall violate any applicable law and is held to be unenforceable, then the invalidity of such provision shall not invalidate any other provisions herein.*
- 4.03. Applicable law may provide rights and benefits to the purchaser in addition to those provided herein.*

McConnel Limited

CONTENTS

Controls Identification	1
Arm Operation Controls	2
Keypad Button Controls	3
Auto-Reset.....	3
Float Controls	4
Rotor Controls.....	5

NAVIGATOR CONTROLS



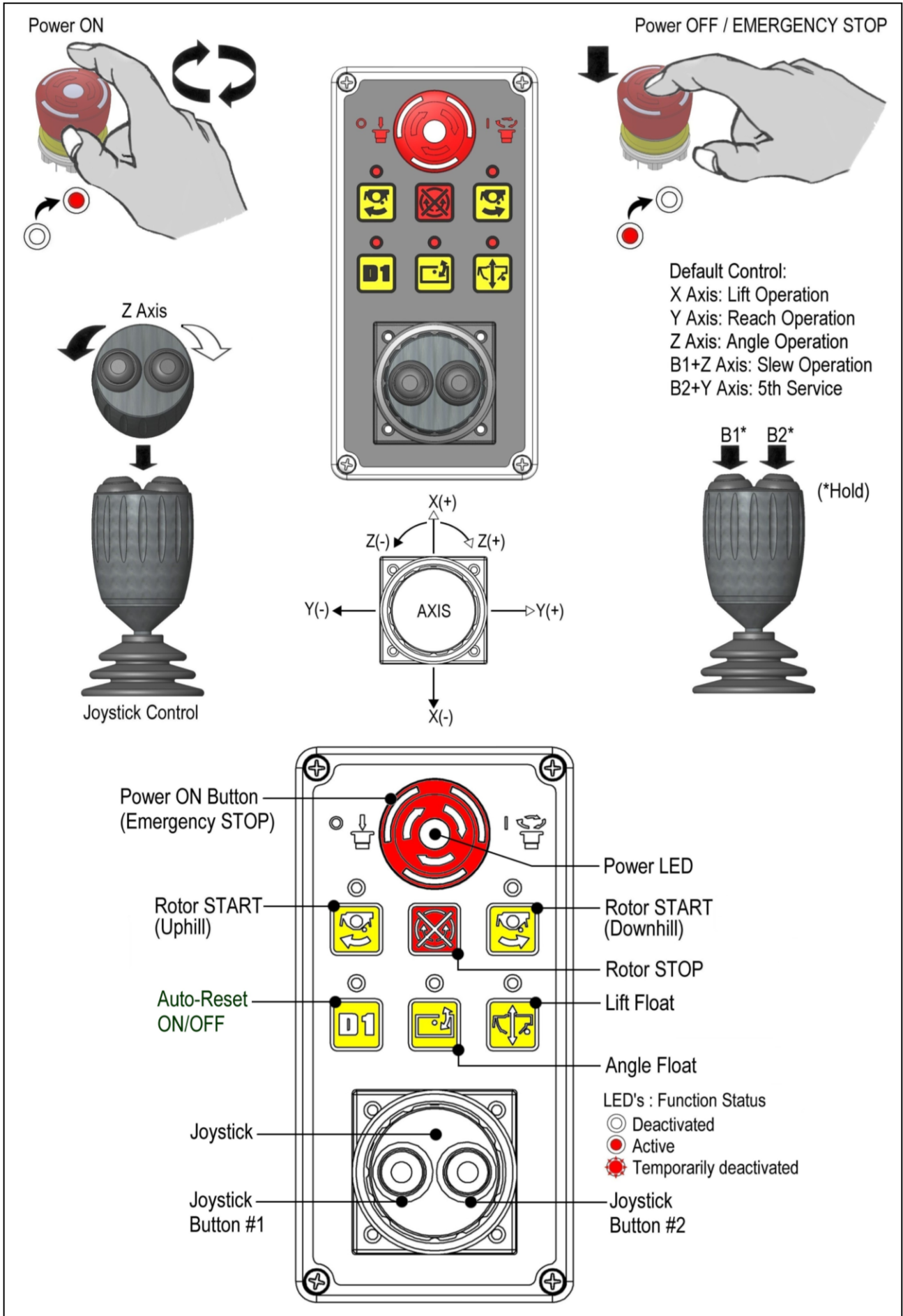



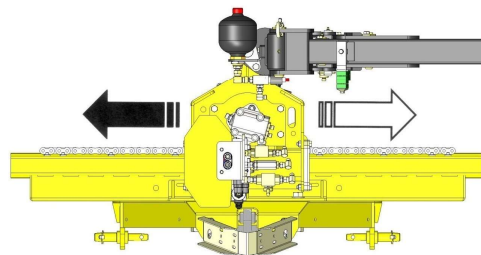
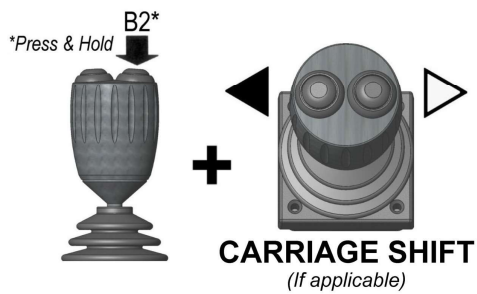
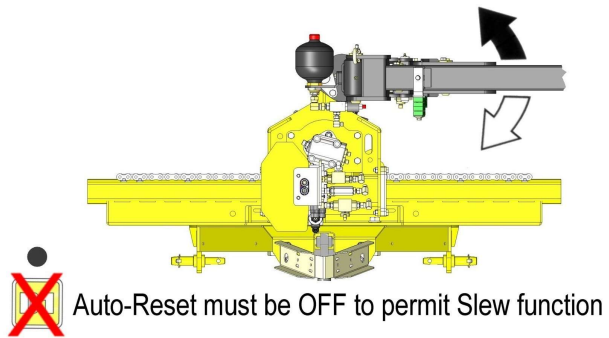
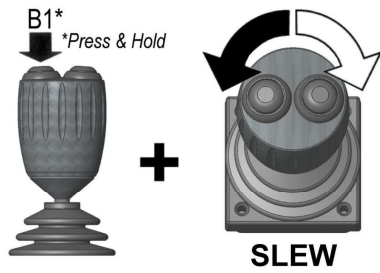
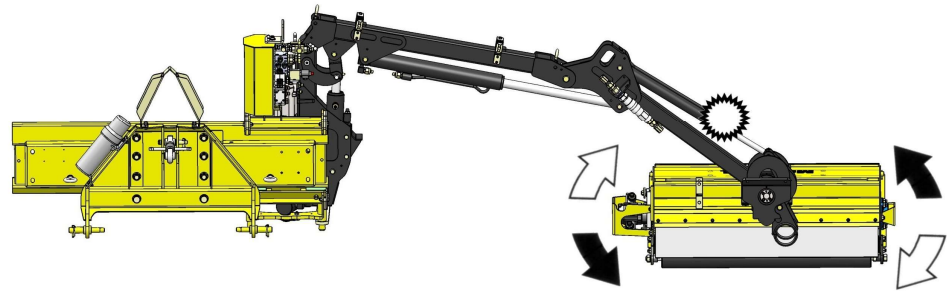
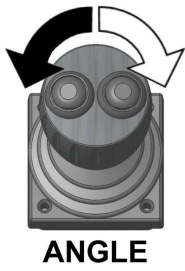
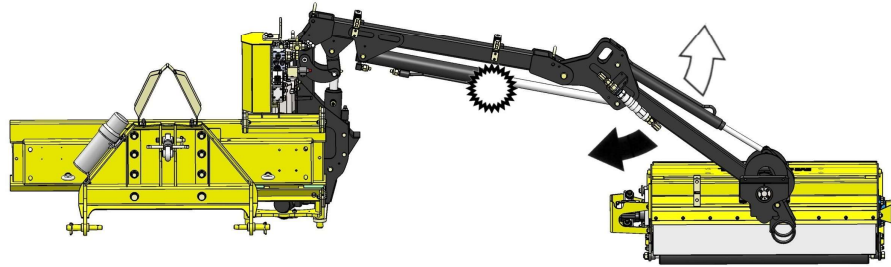
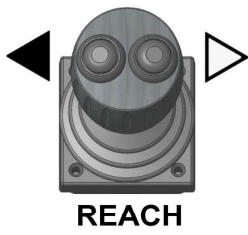
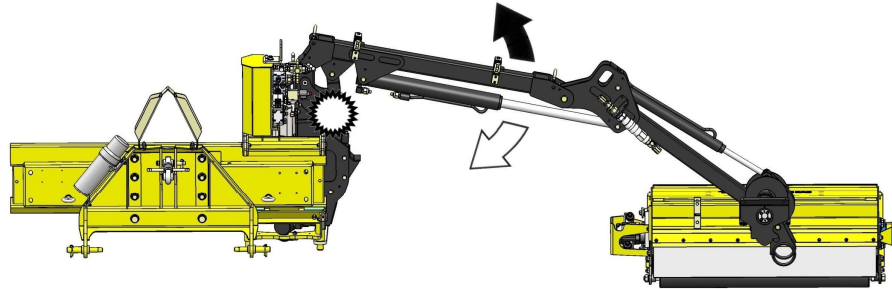

Controls Identification



Arm Operation Controls



Keypad Button Controls

Button	Function	Control Operation
	Angle Float ON/OFF	Pressing the button will switch Angle Float function ON/OFF.
	Lift Float ON/OFF	Pressing the button will switch Lift Float function ON/OFF.
	Rotor START (Uphill Direction)	Press to START rotor in uphill direction. <i>8 second delay for direction change.</i>
	Rotor START (Downhill Direction)	Press to start rotor in downhill direction. <i>8 second delay for direction change.</i>
	Rotor STOP	Press to stop rotor. <i>Press first before direction change.</i>
	Diverter: Auto-Reset ON/OFF	Press to activate/deactivate Auto-Reset.
	Function status - OFF	LED Light for specific control OFF.
	Function status - ON	LED Light for specific control ON.
	Function status temporarily deactivated	LED Light for specific control FLASHING.

Auto-Reset

Auto-reset is activated/deactivated via the **D1** button; *LED is lit when the function is active.* When 'auto-reset' is selected the 'slew' function is disabled; in 'auto-reset' mode, operation of the 'slew' control will only move the arm-set in an up and down direction. **Auto-Reset must be deactivated allow operation of the 'slew' function.**

Float Controls

Angle Float ON/OFF

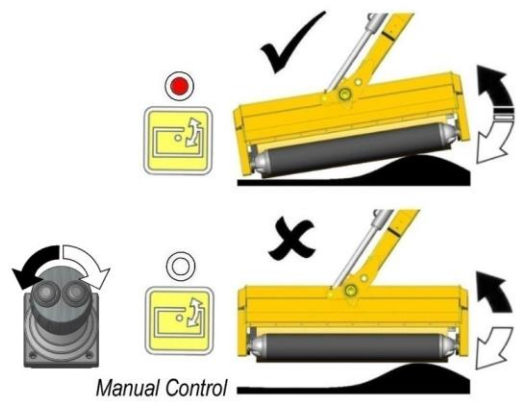
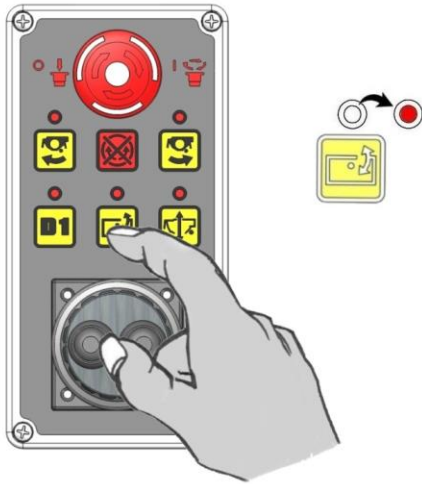

Lift Float ON/OFF

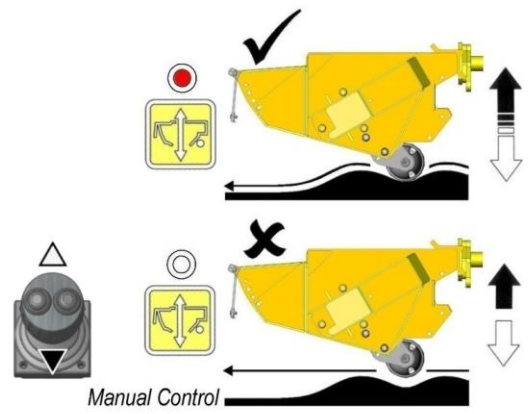
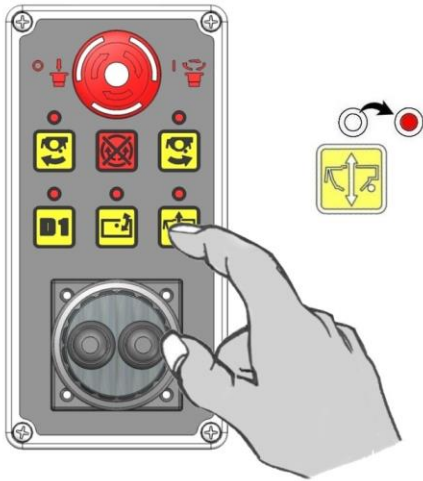

Rotor Controls

Rotor Start - Uphill Cutting

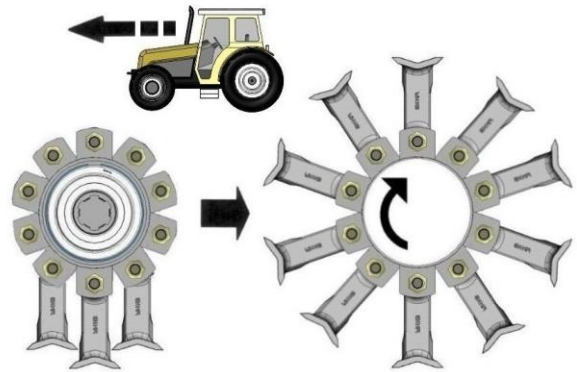
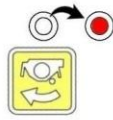

Rotor Start - Downhill Cutting

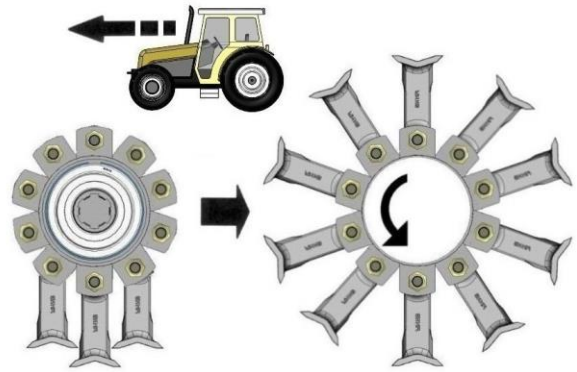
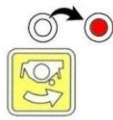
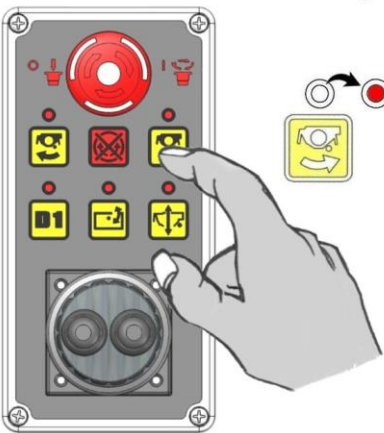

Rotor Stop (Uphill or Downhill)

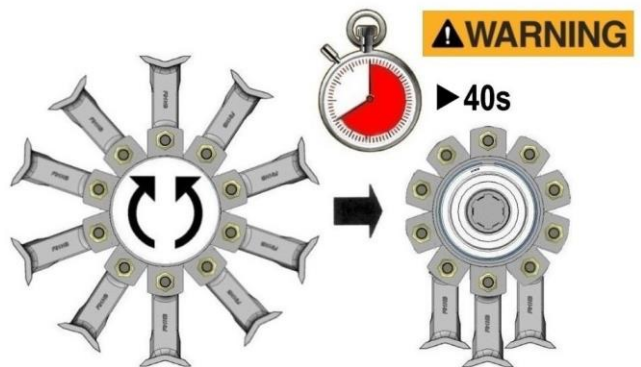
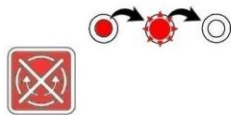

⚠ WARNING



When the rotor is switched off it will continue to 'freewheel' under its own momentum for up to 40 seconds before finally coming to a standstill – do not leave the tractor cab or attempt to approach the flailhead until the rotor has stopped turning completely.



McConnel Limited, Temeside Works, Ludlow, Shropshire SY8 1JL. England.
Telephone: 01584 873131. Facsimile: 01584 876463. www.mcconnel.com