



**COMMANDES MINI MOTION**  
Manuel d'emploi  
(VERSI Machines)



# COMMANDES MINI MOTION

Power SUR

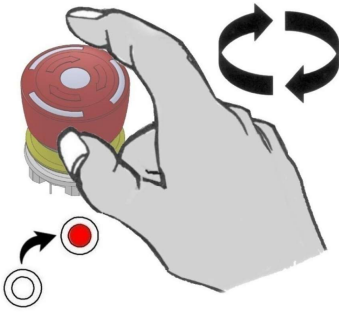

Power DE / ARRÊT D'URGENCE

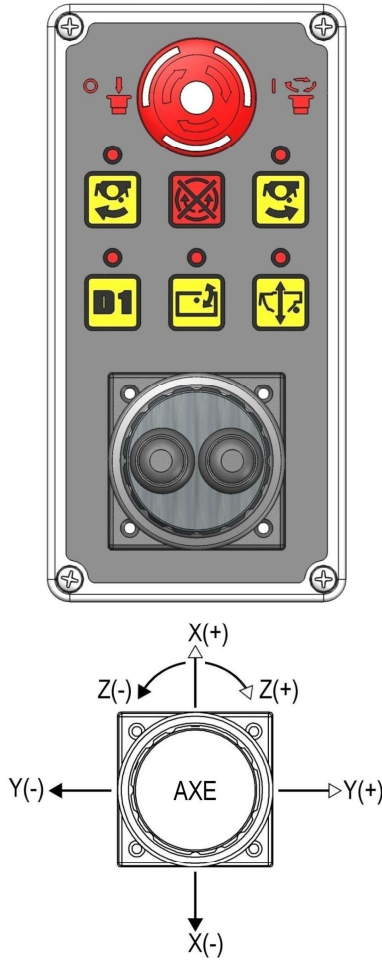
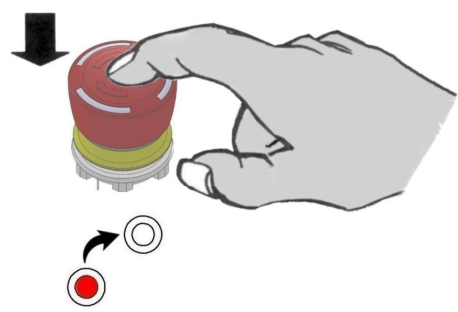

Par défaut de contrôle:  
 Axe X: Levée du bras  
 Axe Y: Portée de bras  
 Axe Z: Angle de la tête  
 B1 + Axe Z: Balayage du bras  
 B2 + Axe Y: 5e Fonction



Power SUR Bouton  
(ARRÊT D'URGENCE)

Démarrage du Rotor  
(en montée)

Diverter  
6e Fonction

Joystick

Joystick  
Bouton #1

Power LED

Démarrage du Rotor  
(en descente)

Rotor ARRÊTEZ

Flottement de levage

Flottement angulaire

LED's : Function Status

○ Deactivated

● Active

⊗ Temporarily deactivated

Joystick  
Bouton #2

# Commande le fonctionnement Arm

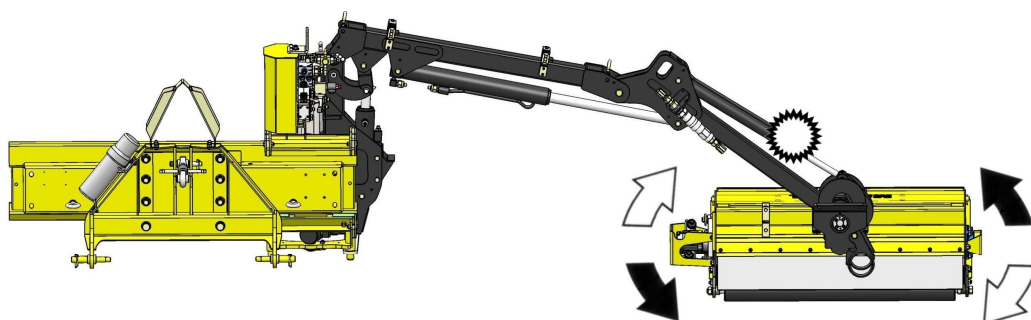
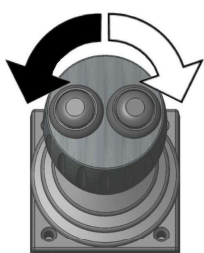
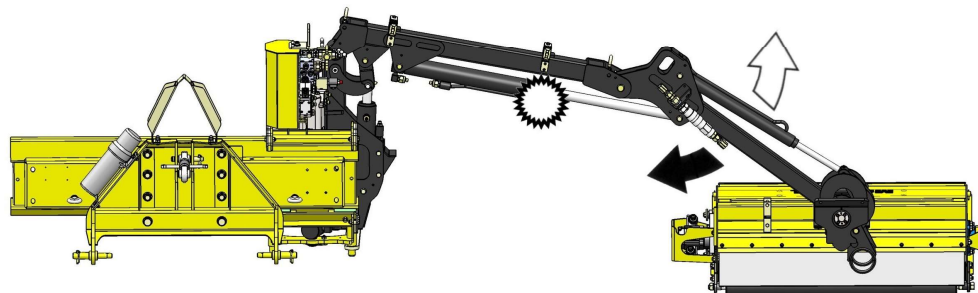
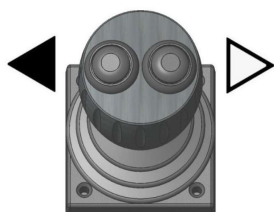
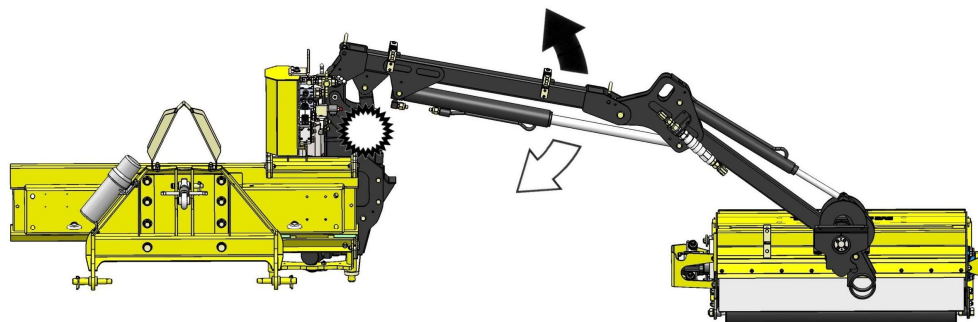
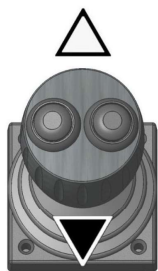



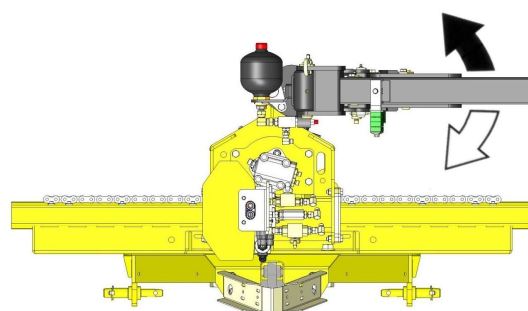
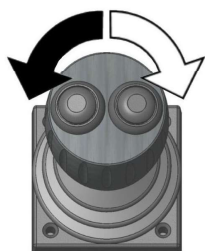



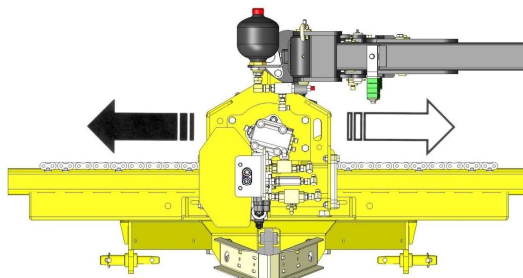
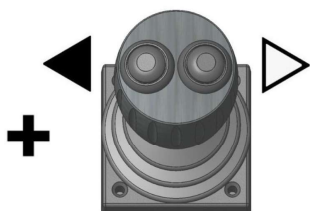

\*Appuyer et maintenir



\*Appuyer et maintenir



## Boutons de commande du clavier

Bouton	Fonction	Opération de commande
	Flottement angulaire activé/désactivé.	Appuyer sur le bouton active/désactive la fonction de flottement angulaire.
	Flottement de levage activé/désactivé.	Appuyer sur le bouton active/désactive la fonction flottement de levage.
	DÉMARRAGE du rotor (en montée).	Appuyer pour démarrer le rotor. <i>Retard de 8 secondes pour un changement de sens.</i>
	DÉMARRAGE du rotor (en descente).	Appuyer pour démarrer le rotor. <i>Retard de 8 secondes pour un changement de sens.</i>
	ARRÊT du rotor.	Appuyer pour arrêter le rotor. <i>Appuyer d'abord avant un changement de sens.</i>
	Sélecteur n° 1 : Activation du 6 <sup>e</sup> service.	Appuyer sur le bouton active/désactive le 6 <sup>e</sup> service.
	État de la fonction – Désactivée.	Voyant DEL pour commande spécifique éteint.
	État de la fonction – Activée.	Voyant DEL pour commande spécifique allumé.
	État de la fonction – Temporairement désactivée.	Voyant DEL pour commande spécifique CLIGNOTANT.

# FONCTIONNEMENT DU FLOTTEUR

## Flottement angulaire activé/désactivé

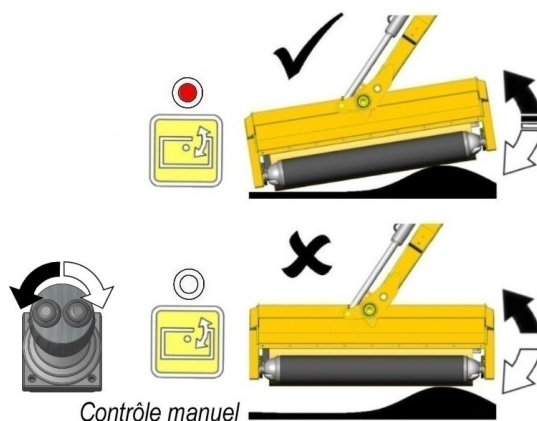
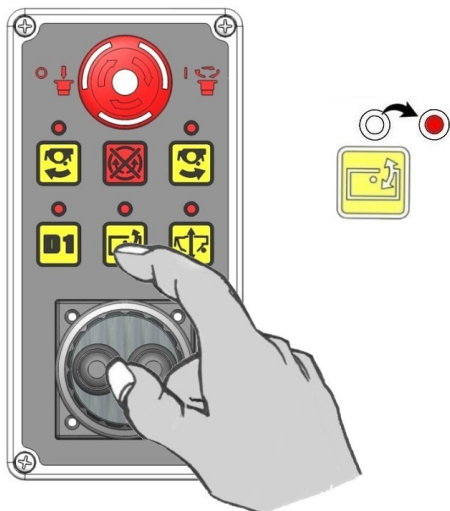

## Flottement de levage activé/désactivé

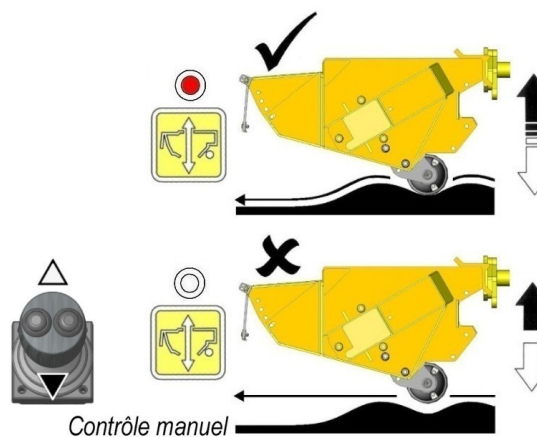
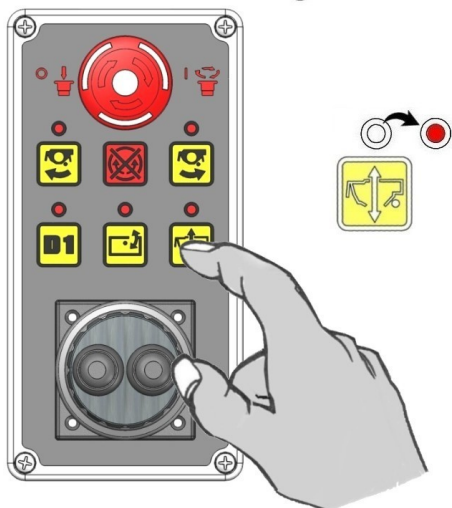

# ROTOR FONCTIONNEMENT

## DÉMARRAGE du rotor (en montée)

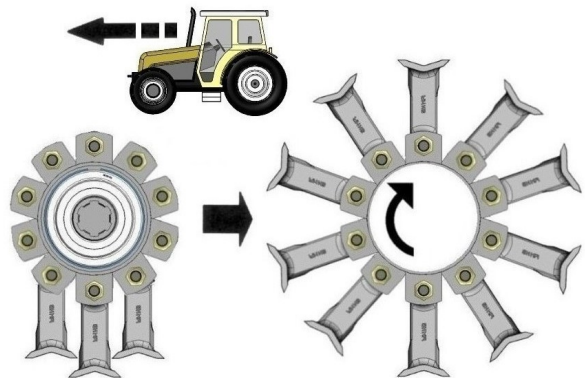
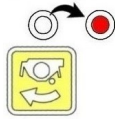

## DÉMARRAGE du rotor (en descente)

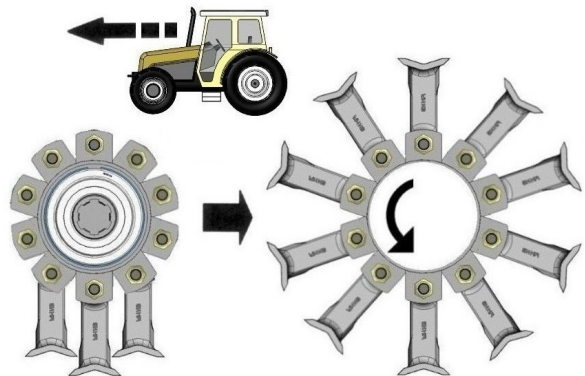
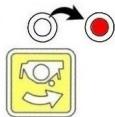
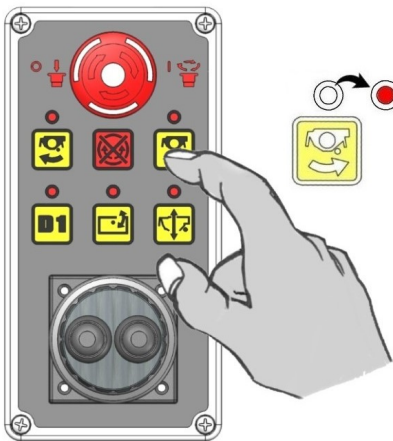

## ARRÊT du rotor

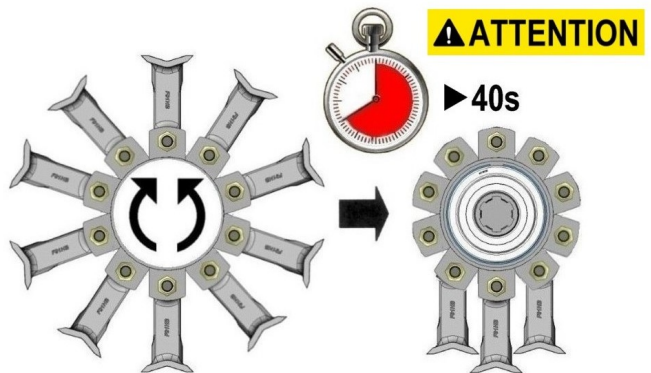
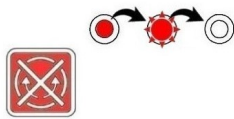

## ATTENTION



Assurez que le rotor a arrêté complètement avant de changer la direction. - Quand on arrête le rotor, on peut remarquer qu'il continue de tourner en roue libre pendant une période considérable ; dans certains cas, cela peut aller jusqu'à 40 secondes.









McConnel Limited, Temeside Works, Ludlow, Shropshire SY8 1JL. England.  
Telephone: 01584 873131. Facsimile: 01584 876463. [www.mcconnel.com](http://www.mcconnel.com)