

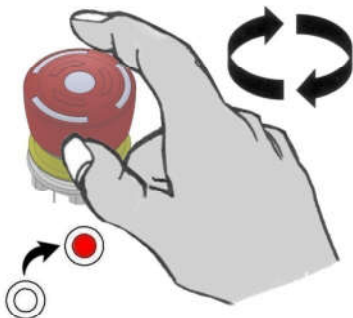

MINI MOTION MANÖVERORGAN  
Bruksanvisning

# MINI MOTION MANÖVERORGAN

Ström PÅ



Ström AV / NÖDSTOPP

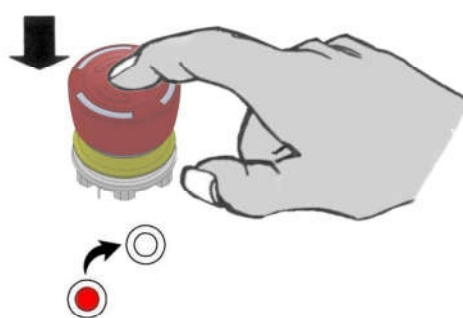

Standardreglage:  
 X-axel: Lyftförelse  
 Y-axel: Utvikning  
 Z-axel: Vinkling  
 B1+Z-axel: Vridning  
 B2+Y-axel: 5:e funktion



Joystick Control

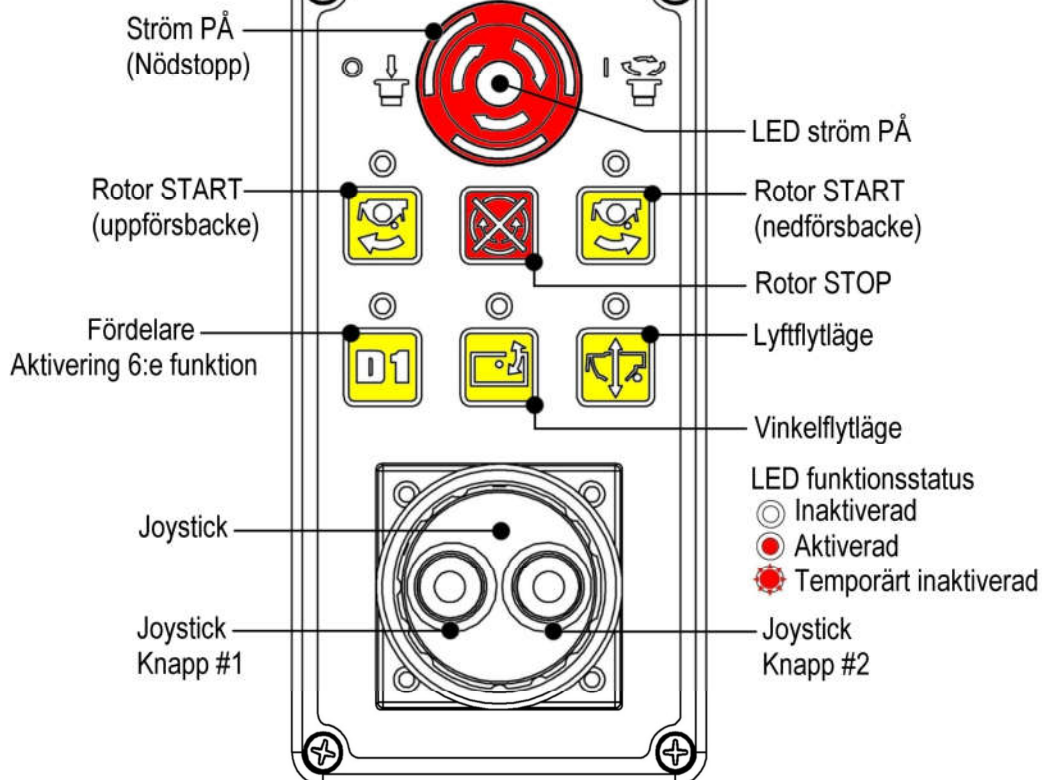
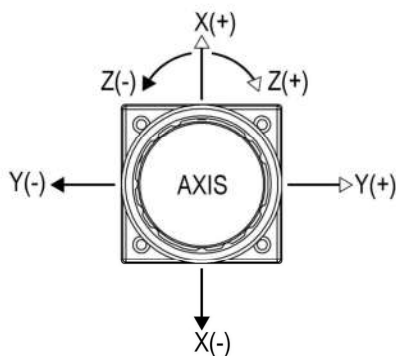

# Manövrering av utliggarens rörelser

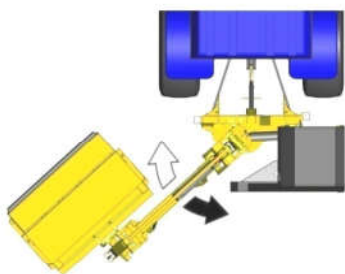
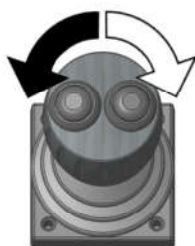
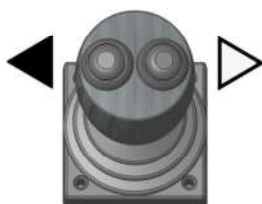

B1\*

\*Tryck och håll ned



+

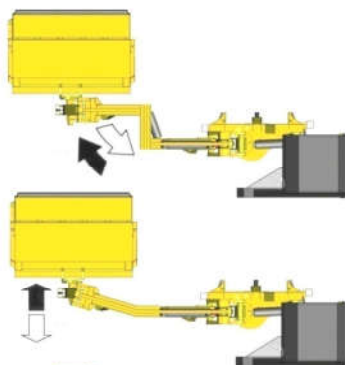
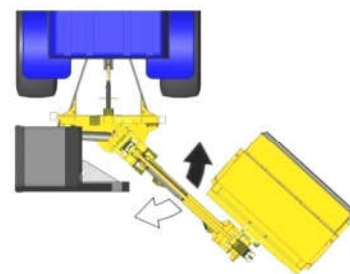
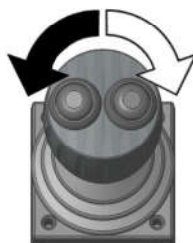

\*Tryck och håll ned

B2\*





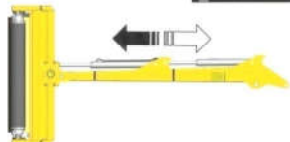
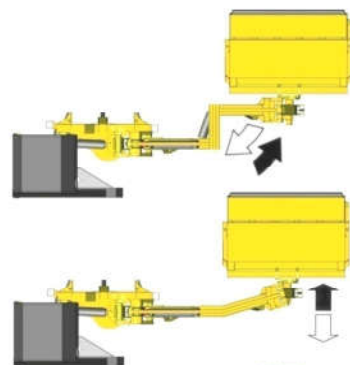
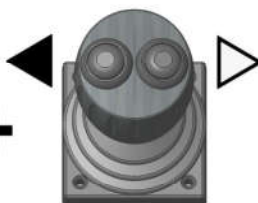



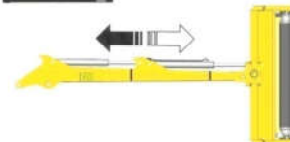

+



Gäller för 5:e service  
(t.ex. Mittklippn./ VFR / Teleskop)



## Manöverknappar på reglagepanel

Knapp	Funktion	Manövrering av reglage
	Vinkelflytläge PÅ/AV.	Trycks knappen in slås vinkelflytfunktionen PÅ/AV.
	Lyftflytläge PÅ/AV.	Trycks knappen in slås lyftflytfunktionen PÅ/AV.
	Rotor START (riktning uppförsbacke).	Tryck för att STARTA rotorn med rotationsriktning uppförsbacke. <i>8 sekunders fördröjning vid riktningssväxling.</i>
	Rotor START (riktning nedförsbacke).	Tryck för att starta rotorn med rotationsriktning nedförsbacke. <i>8 sekunders fördröjning vid riktningssväxling.</i>
	Rotor STOPP.	Tryck in för att stoppa rotorn. <i>Tryck in först före riktningssväxling.</i>
	Fördelare: 6:e Serviceaktivering.	Tryck på omkopplaren 6:e Service PÅ/AV.
	Funktionsstatus - AV.	LED för specifik manövrering AV.
	Funktionsstatus - PÅ.	LED för specifik manövrering PÅ.
	Funktionsstatus - Temporärt inaktiverad.	LED för specifik manövrering BLINKAR.

# ANVÄNDNING AV FLYTLÄGE

## Vinkelflytläge PÅ/AV

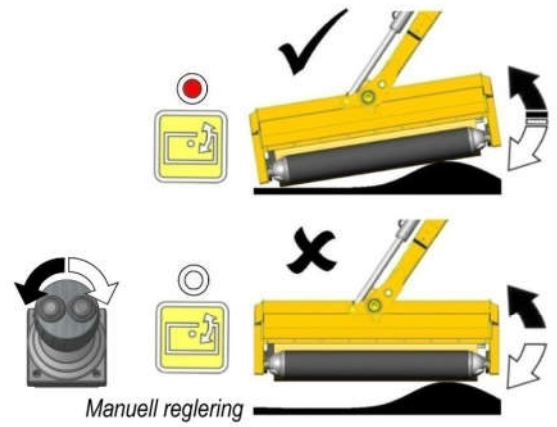
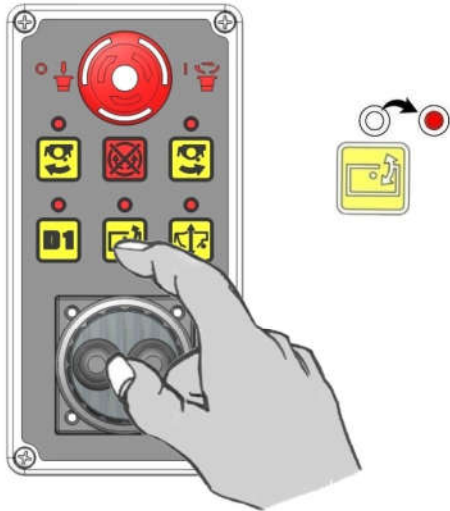

## Lyfflytläge PÅ/AV

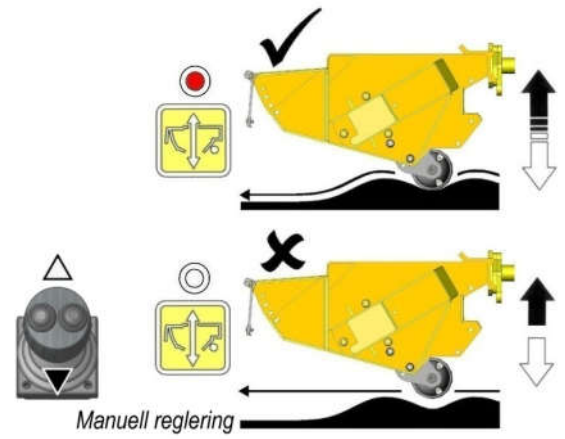
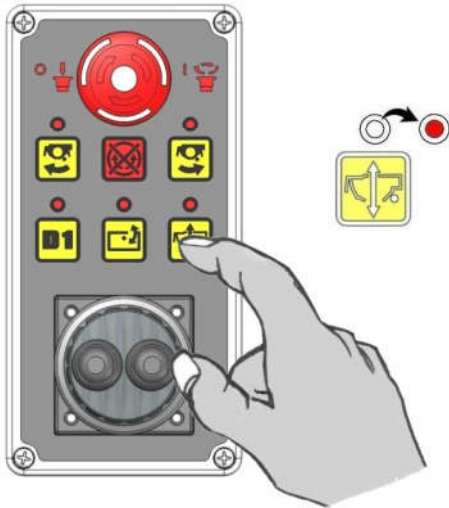



# DRIFT AV ROTOR

## Starta rotor - klippning uppförsbacke

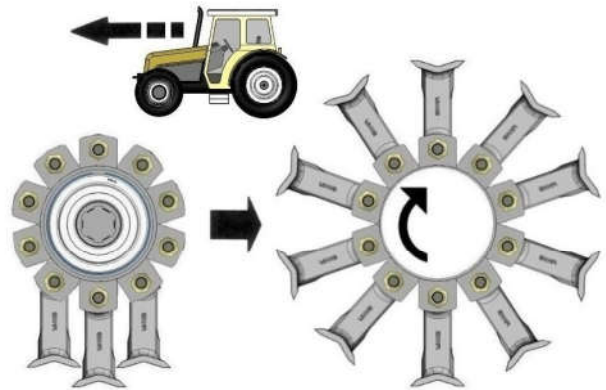
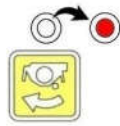
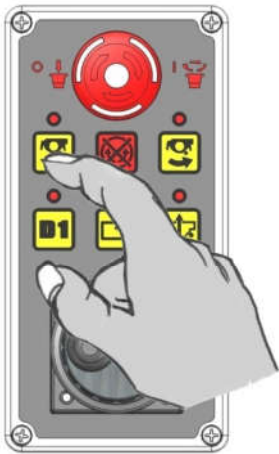

## Starta rotor - klippning nedförsbacke

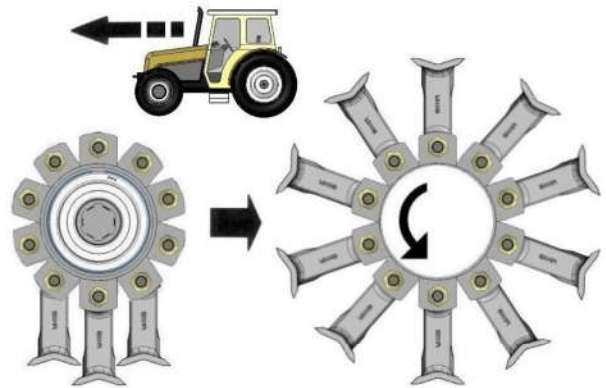
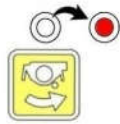
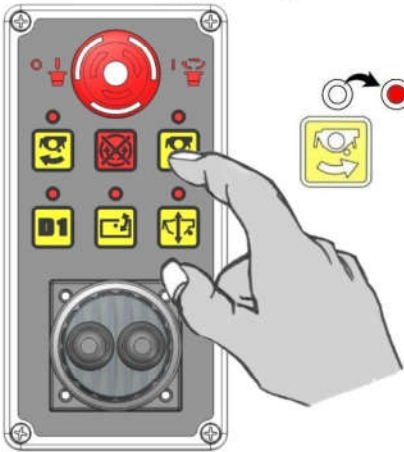

## Stoppa rotor - (uppförsbacke eller nedförsbacke)

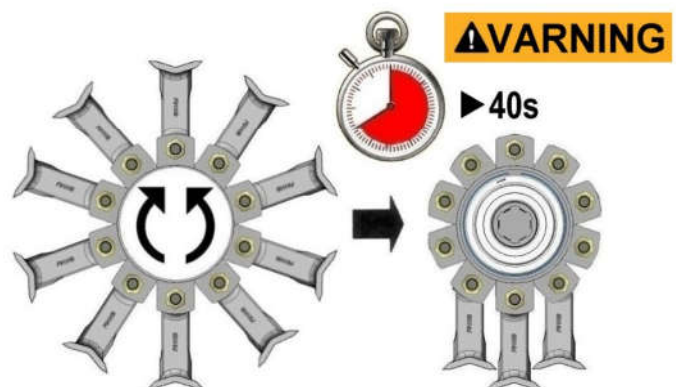
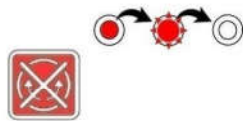
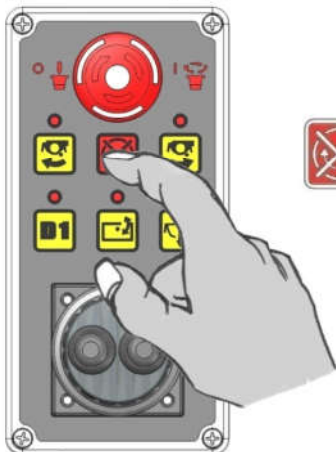

## ⚠️WARNING



När rotorn stängs av kommer den genom sin masströghet att fortsätta att rotera i upp till 40 sekunder innan den stannar helt – lämna inte traktorhytten och försök inte att närma dig slagklipparen innan rotorn helt har slutat rotera.





McConnel Limited, Temeside Works, Ludlow, Shropshire SY8 1JL. England.  
Telephone: 01584 873131. Facsimile: 01584 876463. [www.mcconnel.com](http://www.mcconnel.com)