

Publication 939
May 2019
Part No. 24214.39

McCONEL

MULTISAW

1.5M, 2.0M & 2.5M Models

Operator Manual



IMPORTANT

VERIFICATION OF WARRANTY REGISTRATION



Dealer Warranty Information & Registration Verification

It is imperative that the selling dealer registers this machine with McConnel Limited before delivery to the end user – failure to do so may affect the validity of the machine warranty.

To register machines; log onto <https://my.mcconnel.com> and select 'Machine Registration' which can be found in the 'Warranty' section of the site. **Confirm to the customer that the machine has been registered by completing the verification form below.**

Registration Verification	Serial No. <input type="text"/>
Dealer Name:	
Dealer Address:	
Customer Name:	
Date of Warranty Registration:/...../.....	Dealer Signature:

Note to Customer / Owner

Please ensure the section above has been completed and signed by the dealer to verify your machine has been registered with McConnel Limited.

IMPORTANT: During the initial 'bedding in' period of a new machine it is the customer's responsibility to regularly inspect all nuts, bolts and hose connections for tightness and re-tighten if required. New hydraulic connections occasionally weep small amounts of oil as the seals and joints settle in – where this occurs it can be cured by re-tightening the connection – *refer to torque settings chart below*. The tasks stated above should be performed on an hourly basis during the first day of work and at least daily thereafter as part of the machine's general maintenance procedure.

CAUTION: DO NOT OVER TORQUE HYDRAULIC FITTINGS AND HOSES

Torque Settings for Hydraulic Fittings

Hydraulic Hose Ends		
BSP	Setting	Metric
1/4"	18 Nm	19 mm
3/8"	31 Nm	22 mm
1/2"	49 Nm	27 mm
5/8"	60 Nm	30 mm
3/4"	80 Nm	32 mm
1"	125 Nm	41 mm
1.1/4"	190 Nm	50 mm
1.1/2"	250 Nm	55 mm
2"	420 Nm	70 mm

Port Adaptors with Bonded Seals		
BSP	Setting	Metric
1/4"	34 Nm	19 mm
3/8"	47 Nm	22 mm
1/2"	102 Nm	27 mm
5/8"	122 Nm	30 mm
3/4"	149 Nm	32 mm
1"	203 Nm	41 mm
1.1/4"	305 Nm	50 mm
1.1/2"	305 Nm	55 mm
2"	400 Nm	70 mm

WARRANTY POLICY

WARRANTY REGISTRATION

All machines must be registered, by the selling dealer with McConnel Ltd, before delivery to the end user. On receipt of the goods it is the buyer's responsibility to check that the Verification of Warranty Registration in the Operator's Manual has been completed by the selling dealer.

1. LIMITED WARRANTIES

- 1.01. *All mounted machines supplied by McConnel Ltd are warranted to be free from defects in material and workmanship from the date of sale to the original purchaser for a period of 12 months, unless a different period is specified.
All Self Propelled Machines supplied by McConnel Ltd are warranted to be free from defects in material and workmanship from the date of sale to the original purchaser for a period of 12 months or 1500 hours. Engine warranty will be specific to the Manufacturer of that unit.*
- 1.02. *All spare parts supplied by McConnel Ltd and purchased by the end user are warranted to be free from defects in material and workmanship from the date of sale to the original purchaser for a period of 6 months. All parts warranty claims must be supported by a copy of the failed part invoice to the end user. We cannot consider claims for which sales invoices are not available.*
- 1.03. *The warranty offered by McConnel Ltd is limited to the making good by repair or replacement for the purchaser any part or parts found, upon examination at its factory, to be defective under normal use and service due to defects in material or workmanship. Returned parts must be complete and unexamined. Pack the component(s) carefully so that any transit damage is avoided. All ports on hydraulic items should be drained of oil and securely plugged to prevent seepage and foreign body ingress. Certain other components, electrical items for example, may require particular care when packing to avoid damage in transit.*
- 1.04. *This warranty does not extend to any product from which McConnel Ltd's serial number plate has been removed or altered.*
- 1.05. *The warranty policy is valid for machines registered in line with the terms and conditions detailed and on the basis that the machines do not extend a period of 24 months or greater since their original purchase date, that is the original invoice date from McConnel Limited.
Machines that are held in stock for more than 24 months cannot be registered for warranty.*
- 1.06. *This warranty does not apply to any part of the goods, which has been subjected to improper or abnormal use, negligence, alteration, modification, fitment of non-genuine parts, accident damage, or damage resulting from contact with overhead power lines, damage caused by foreign objects (e.g. stones, iron, material other than vegetation), failure due to lack of maintenance, use of incorrect oil or lubricants, contamination of the oil, or which has served its normal life. This warranty does not apply to any expendable items such as blades, belts, clutch linings, filter elements, flails, flap kits, skids, soil engaging parts, shields, guards, wear pads, pneumatic tyres or tracks.*
- 1.07. *Temporary repairs and consequential loss - i.e. oil, downtime and associated parts are specifically excluded from the warranty.*
- 1.08. *Warranty on hoses is limited to 12 months and does not include hoses which have suffered external damage. Only complete hoses may be returned under warranty, any which have been cut or repaired will be rejected.*
- 1.09. *Machines must be repaired immediately a problem arises. Continued use of the machine after a problem has occurred can result in further component failures, for which McConnel Ltd cannot be held liable, and may have safety implications.*
- 1.10. *If in exceptional circumstances a non McConnel Ltd part is used to effect a repair, warranty reimbursement will be at no more than McConnel Ltd's standard dealer cost for the genuine part.*

- 1.11. *Except as provided herein, no employee, agent, dealer or other person is authorised to give any warranties of any nature on behalf of McConnell Ltd.*
- 1.12. *For machine warranty periods in excess of 12 months the following additional exclusions shall apply:*
 - 1.12.1. *Hoses, exposed pipes and hydraulic tank breathers.*
 - 1.12.2. *Filters.*
 - 1.12.3. *Rubber mountings.*
 - 1.12.4. *External electric wiring.*
 - 1.12.5. *Bearings and seals*
 - 1.12.6. *External Cables, Linkages*
 - 1.12.7. *Loose/Corroded Connections, Light Units, LED's*
 - 1.12.8. *Comfort items such as Operator Seat, Ventilation, Audio Equipment*
- 1.13. *All service work, particularly filter changes, must be carried out in accordance with the manufacturer's service schedule. Failure to comply will invalidate the warranty. In the event of a claim, proof of the service work being carried out may be required.*
- 1.14. *Repeat or additional repairs resulting from incorrect diagnosis or poor quality previous repair work are excluded from warranty.*

NB Warranty cover will be invalid if any non-genuine parts have been fitted or used. Use of non-genuine parts may seriously affect the machine's performance and safety. McConnell Ltd cannot be held responsible for any failures or safety implications that arise due to the use of non-genuine parts.

2. REMEDIES AND PROCEDURES

- 2.01. *The warranty is not effective unless the Selling Dealer registers the machine, via the McConnell web site and confirms the registration to the purchaser by completing the confirmation form in the operator's manual.*
- 2.02. *Any fault must be reported to an authorised McConnell Ltd dealer as soon as it occurs. Continued use of a machine, after a fault has occurred, can result in further component failure for which McConnell Ltd cannot be held liable.*
- 2.03. *Repairs should be undertaken within two days of the failure. Claims submitted for repairs undertaken more than 2 weeks after a failure has occurred, or 2 days after the parts were supplied will be rejected, unless the delay has been authorised by McConnell Ltd. Please note that failure by the customer to release the machine for repair will not be accepted as a reason for delay in repair or submitting warranty claims.*
- 2.04. *All claims must be submitted, by an authorised McConnell Ltd Service Dealer, within 30 days of the date of repair.*
- 2.05. *Following examination of the claim and parts, McConnell Ltd will pay, at their discretion, for any valid claim the invoiced cost of any parts supplied by McConnell Ltd and appropriate labour and mileage allowances if applicable.*
- 2.06. *The submission of a claim is not a guarantee of payment.*
- 2.07. *Any decision reached by McConnell Ltd. is final.*

3. LIMITATION OF LIABILITY

- 3.01. *McConnell Ltd disclaims any express (except as set forth herein) and implied warranties with respect to the goods including, but not limited to, merchantability and fitness for a particular purpose.*
- 3.02. *McConnell Ltd makes no warranty as to the design, capability, capacity or suitability for use of the goods.*
- 3.03. *Except as provided herein, McConnell Ltd shall have no liability or responsibility to the purchaser or any other person or entity with respect to any liability, loss, or damage caused or alleged to be caused directly or indirectly by the goods including, but not limited to, any indirect, special, consequential, or incidental damages resulting from the use or operation of the goods or any breach of this warranty. Notwithstanding the above limitations and warranties, the manufacturer's liability hereunder for damages incurred by the purchaser or others shall not exceed the price of the goods.*
- 3.04. *No action arising out of any claimed breach of this warranty or transactions under this warranty may be brought more than one (1) year after the cause of the action has occurred.*

4. MISCELLANEOUS

- 4.01. *McConnel Ltd may waive compliance with any of the terms of this limited warranty, but no waiver of any terms shall be deemed to be a waiver of any other term.*
- 4.02. *If any provision of this limited warranty shall violate any applicable law and is held to be unenforceable, then the invalidity of such provision shall not invalidate any other provisions herein.*
- 4.03. *Applicable law may provide rights and benefits to the purchaser in addition to those provided herein.*

McConnel Limited

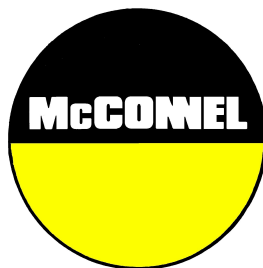

For Safety and Performance ...

ALWAYS READ THE BOOK FIRST



McCONEL LIMITED

**Temeside Works
Ludlow
Shropshire
England**

**Telephone: +44 (0)1584 873131
www.mcconel.com**



In line with our policy of constant improvement, this publication will be periodically updated; to ensure you have access to the latest version of this manual please visit the manuals library on our website where an 'up-to-date' version can be referenced online, or downloaded.

<https://www.mcconel.com/support/parts-and-operators-manual/>

CONTENTS

General Information.....	1
Overview	2
Safety Information	3
Safety Decals	7
Vehicle / Tractor Preparation.....	8
Handling the Machine.....	9
Machine Attachment.....	10
Hydraulic Installation	12
Belts Access.....	12
Operation.....	13
Maintenance.....	14
Initial Maintenance	14
Routine Maintenance.....	14
Checking Belt Tension.....	14
Tensioning Belts	15
Belt Tension Settings – 1.5m Multisaws	16
Belt Tension Settings – 2.0m Multisaws	17
Belt Tension Settings – 2.5m Multisaws	18
Replacing Blades	19

GENERAL INFORMATION

Read this manual before fitting or operating the machine or accessory. Whenever any doubt exists contact your local dealer or the McConnel Service Department for assistance.

Only use 'Genuine McConnel Parts' on McConnel machinery and equipment.

DEFINITIONS: *The following definitions apply throughout this manual;*

⚠ DANGER

DANGER: Alerts to a hazardous situation which will result in death or serious injury if not observed carefully.

⚠ WARNING

WARNING: Alerts to a hazardous situation which could result in death or serious injury if not observed carefully.

⚠ CAUTION

CAUTION: Alerts to a hazardous situation which could result in damage to the machine and/or equipment if not observed carefully.

NOTICE

NOTICE: Specific or general information considered important or useful to emphasise.

LEFT HAND (LH) & RIGHT HAND (RH): *These terms are applicable to the machine when fitted to the tractor and viewed from the rear; these terms also apply to tractor references.*

SERIAL PLATE

All machines are equipped with a serial number plate containing important information relating to the machine including a unique serial number used for identification purposes.

Note: Images in this manual are provided for instruction and informational purposes only and may not show components in their entirety. In certain instances images may appear different to the actual machine; where this occurs the general procedure will be basically the same. E&OE.

MACHINE & DEALER INFORMATION

Record the serial number of your machine on this page and always quote it when ordering parts. Whenever information concerning the machine is requested remember to also state the make and model of tractor to which the machine is fitted.	
Machine Serial Number:	Installation Date:
Machine Model Details:	
Dealer Name & Branch:	
Dealer Address:	
Dealer Telephone No:	
Dealer Email Address:	

OVERVIEW

McConel Heavy-duty Multisaws are hydraulic boom mounted saw-blade attachments for the cutting of trees and branches. Available in working widths of 1.5m, 2.0m & 2.5m, the machines are equipped with belt-driven tungsten carbide tipped saw-blades capable of cutting materials up to 150mm diameter.

Designed for use on larger model Power Arms, the Multisaw is the ideal machine for farmers, forestry teams and contractors alike.

This machine must only be used to perform the tasks for which it was designed, use for any other purpose may be dangerous to persons and damaging to the machine.

SPECIFICATIONS

Specification / Model	Multisaw 1500 HD	Multisaw 2000 HD	Multisaw 2500 HD
Working Width	1.5m	2.0m	2.5m
Number Blades	3	4	4
Blade Diameter	490mm (19¼")	490mm (19¼")	620mm (24½")
Blade Material	Tungsten Carbide Tipped	Tungsten Carbide Tipped	Tungsten Carbide Tipped
Blade Speed	3000 RPM	3000 RPM	3000 RPM
Blade Tip Speed	76.9 m/s	76.9 m/s	97.3 m/s
Motor	Hydraulic 40.6cc	Hydraulic 40.6cc	Hydraulic 40.6cc
Flow Rate	124 l/min @ 210 bar	124 l/min @ 210 bar	124 l/min @ 210 bar
Drive	V-belt	V-belt	V-belt
Cutting Capacity	150mm (6")	150mm (6")	150mm (6")
Main Application	Vertical Cutting	Vertical Cutting	Vertical Cutting
Forward Operating Speed	5km/h (3mph)	5km/h (3mph)	5km/h (3mph)
Weight	180kg (397lbs)	220kg (485lbs)	255kg (562lbs)

Noise Level

The energy A-weighted sound pressure is below 90 dB (A).

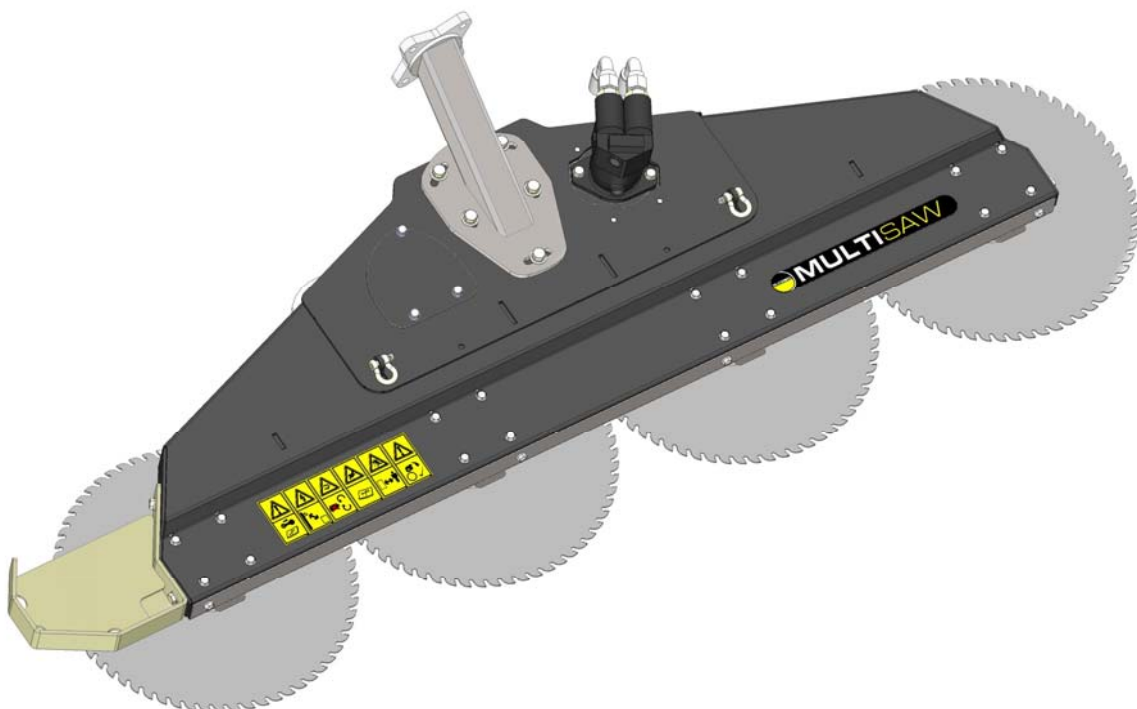













This machine has the potential to be extremely dangerous - in the wrong hands it can kill or maim; it is therefore imperative that both owner and operator of the machine reads and understands the following section to ensure they are fully aware of the dangers that do, or may exist, and their responsibilities surrounding the use and operation of the machine. The operator of this machine is responsible not only for their own safety but equally for the safety of others who may come into the close proximity of the machine, as the owner you are responsible for both.

















All operators must be fully competent in the use of this machine and also the machine to which it is attached and must read and understand the operation manuals for both machines before attempting to attach or operate this equipment.



When the machine is not in use it should be lowered to rest on the ground. In the event of any fault being detected with the machine's operation it must be stopped immediately and not used again until the fault has been corrected by a qualified technician.

POTENTIAL DANGERS ASSOCIATED WITH THE USE OF THIS MACHINE:



















-  *Being hit by debris thrown by rotating components.*
-  *Being hit by machine parts ejected through damage during use.*
-  *Being caught on a rotating power take-off (PTO) shaft.*
-  *Being caught in other moving parts i.e.: belts, pulleys and cutting heads.*
-  *Electrocution from Overhead Power Lines (by contact with or 'flashover' from).*
-  *Being hit by cutting heads or machine arms as they move.*
-  *Becoming trapped between tractor and machine when hitching or unhitching.*
-  *Tractor overbalancing when machine arm is extended.*
-  *Injection of high-pressure oil from hydraulic hoses or couplings.*
-  *Machine overbalancing when freestanding (out of use).*
-  *Road traffic accidents due to collision or debris on the road.*

BEFORE USING THIS MACHINE YOU MUST:

-  *Ensure you read all sections of the operator handbook.*
-  *Ensure the operator is, or has been, properly trained to use the machine.*
-  *Ensure the operator has been issued with and reads the operator handbook.*
-  *Ensure the operator understands and follows the instructions in operator handbook.*
-  *Ensure the tractor front, rear and sides are fitted with metal mesh or polycarbonate guards of suitable size and strength to protect the operator against thrown debris or parts.*
-  *Ensure tractor guards are fitted correctly, are undamaged and kept properly maintained.*
-  *Ensure that all machine guards are in position, are undamaged, and are kept maintained in accordance with the manufacturer's recommendations.*
-  *Ensure blades and their fixings are of a type recommended by the manufacturer, are securely attached and that none are missing or damaged.*
-  *Ensure hydraulic pipes are carefully and correctly routed to avoid damage by chaffing, stretching or pinching and that they are held in place with the correct fittings.*
-  *Always follow the manufacturer's instructions for attachment and removal of the machine from the tractor.*
-  *Check that the machine fittings and couplings are in good condition.*
-  *Ensure the tractor meets the minimum weight recommendations of the machine's manufacturer and that ballast is used as necessary.*
-  *Always inspect the work area thoroughly before starting to note obstacles and remove wire, bottles, cans and other debris.*
-  *Use clear suitably sized warning signs to alert others to the nature of the machine working within that area. Signs should be placed at both ends of the work site. (It is recommended that signs used are of a size and type specified by the Department of Transport and positioned in accordance with their, and the Local Highways Authority, guidelines).*
-  *Ensure the operator is protected from noise. Ear defenders should be worn and tractor cab doors and windows must be kept closed. Machine controls should be routed through proprietary openings in the cab to enable all windows to be shut fully.*
-  *Always work at a safe speed taking account of the conditions i.e.: terrain, highway proximity and obstacles around and above the machine. Extra special attention should be applied to Overhead Power Lines. Some of our machines are capable of reach in excess of 8 metres (26 feet) this means they have the potential to well exceed, by possibly 3 metres (9' 9"), the lowest legal minimum height of 5.2 metres from the ground for 11,000 and 33,000 volt power lines. It cannot be stressed enough the dangers that surround this capability, it is therefore vital that the operator is fully aware of the maximum height and reach of the machine, and that they are fully conversant with all aspects regarding the safe minimum distances that apply when working with machines in close proximity to Power Lines. (Further information on this subject can be obtained from the Health & Safety Executive or your Local Power Company).*

-  Always disengage the machine, kill the tractor engine, remove and pocket the key before dismantling for any reason.
-  Always clear up all debris left at the work area, it may cause hazard to others.
-  Always ensure when you remove your machine from the tractor that it is left in a safe and stable position using the stands and props provided and secured if necessary.

WHEN NOT TO USE THIS MACHINE:

-  Never attempt to use this machine if you have not been trained to do so.
-  Never use a machine until you have read and understood the operator handbook, are familiar with it, and practiced the controls.
-  Never use a machine that is poorly maintained.
-  Never use a machine if guards are missing or damaged.
-  Never use a machine on which the hydraulic system shows signs of wear or damage.
-  Never fit, or use, a machine on a tractor that does not meet the manufacturer's minimum specification level.
-  Never use a machine fitted to a tractor that does not have suitable front, rear and side(s) cab guarding made of metal mesh or polycarbonate.
-  Never use the machine if the tractor cab guarding is damaged, deteriorating or badly fitted.
-  Never turn a machine cutting head to an angle that causes debris to be ejected towards the cab.
-  Never start or continue to work a machine if people are nearby or approaching - Stop and wait until they are at a safe distance before continuing. **WARNING:** Some cutting heads may continue to 'freewheel' for up to 40 seconds or more after being stopped.
-  Never attempt to use a machine on materials in excess of its capability.
-  Never use a machine to perform a task it has not been designed to do.
-  Never operate the tractor or machine controls from any position other than from the driving seat, especially whilst hitching or unhitching the machine.
-  Never carry out maintenance of a machine or a tractor whilst the engine is running – the engine should be switched off, the key removed and pocketed.
-  Never leave a machine unattended in a raised position – it should be lowered to the ground in a safe position on a level firm site.
-  Never leave a tractor with the key in or the engine running.
-  Never carry out maintenance on any part or component of a machine that is raised unless that part or component has been properly substantially braced or supported.
-  Never attempt to detect a hydraulic leak with your hand – use a piece of cardboard.
-  Never allow children near to, or play on, a tractor or machine under any circumstances.

ADDITIONAL SAFETY ADVICE

Training

Operators need to be competent and fully capable of operating this machine in a safe and efficient way prior to attempting to use it in any public place. We advise therefore that the prospective operator make use of relevant training courses available such as those run by the Agricultural Training Board, Agricultural Colleges, Dealers and McConnel.

Working in Public Places

When working in public places such as roadsides, consideration should be paid to others in the vicinity. Stop the machine immediately when pedestrians, cyclists and horse riders etc. pass. Restart only when they are at a distance that causes no risk to their safety.

Warning Signs

It is advisable that any working area be covered by suitable warning signs and statutory in public places. Signs should be highly visible and well placed in order to give clear advanced warning of the hazard. Contact the Department of Transport or your Local Highways Authority to obtain detailed information on this subject. The latter should be contacted prior to working on the public highway advising them of the time and location of the intended work asking what is required by way of signs and procedure. – *'Non-authorised placement of road signs may create offences under the Highways Act'*.

Suggested Warning Signs Required







'Road works ahead' warning sign with a supplementary *'Hedge cutting'* plate. *'For 1 mile'* or appropriate shorter distance may be added to the plate.

'Road narrows' warning signs with supplementary *'Single file traffic'* plate.

White on blue *'Keep right'* (*) arrow sign on rear of machine.

** Note – this applies to UK Market machines where traffic passes to the right of a machine working in the same direction as the traffic flow. The direction, use and colour of the arrow sign will depend on the country of use and the Local Highway Authorities regulations in the locality.*

Use of Warning Signs

-  On two-way roads one set of signs is needed facing traffic in each direction.
-  Work should be within 1 mile of the signs.
-  Work only when visibility is good and at times of low risk e.g.: NOT during 'rush-hour'.
-  Vehicles should have an amber-flashing beacon.
-  Ideally, vehicles should be conspicuously coloured.
-  Debris should be removed from the road and path as soon as practicable, and at regular intervals, wearing high visibility clothing and before removing the hazard warning signs.
-  Collect all road signs promptly when the job is completed.

Safety Gear: It is recommended that the following personal protective equipment is worn when operating and/or maintaining this machine; Coveralls, safety boots, safety glasses, hearing protection, safety helmet, protective gloves, and protective dust mask.



Although the information stated here covers a wide range of safety subjects it is impossible to predict every eventuality that can occur under differing circumstances whilst operating this machine. No advice given here can replace 'good common sense' and 'total awareness' at all times, but will go a long way towards the safe use of your McConnel machine.

SAFETY DECALS

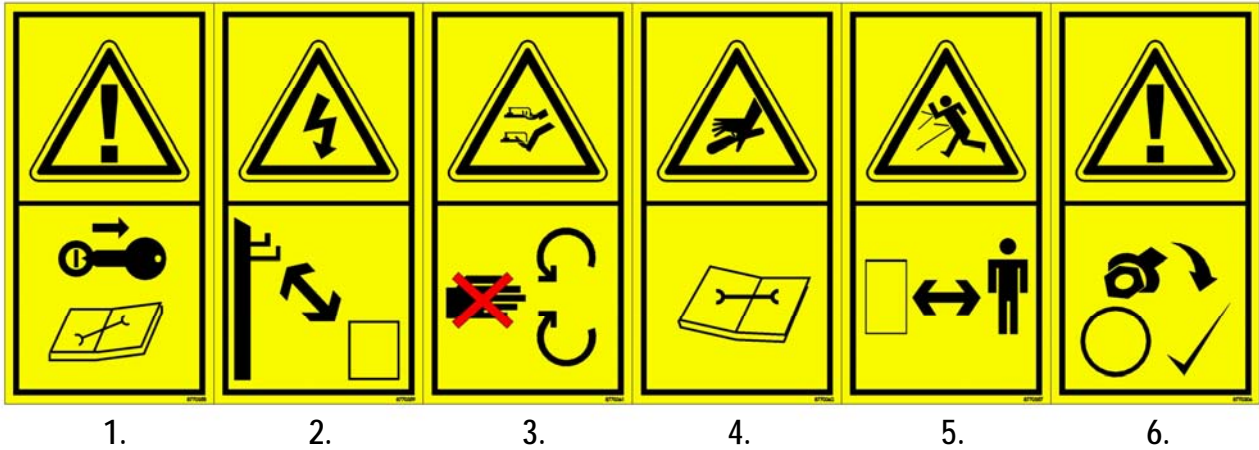

⚠ WARNING

1. Stop engine and remove key before performing maintenance or repair work.

⚠ WARNING

2. Danger: keep clear of overhead power lines. Where doubt exists contact your local power company for advice.

⚠ WARNING

3. Danger: keep clear of rotating blades.

⚠ WARNING

4. Pressurised oil, beware of leaks. Consult technical manual for service procedures.

⚠ WARNING

5. Danger: flying objects. Keep a safe distance from the machine when the engine is running.

⚠ WARNING

6. Check tightness of bolts every 8 hours – retighten if required.

VEHICLE / TRACTOR PREPARATION

We recommend vehicles are fitted with cabs using 'safety glass' windows and protective guarding when used with our machines.

Fit Operator Guard (Part No. 7313324) using the hooks provided. Shape the mesh to cover all vulnerable areas. The driver must be looking through mesh and/or polycarbonate glazing when viewing the flail head in any working position - unless the vehicle/ cab

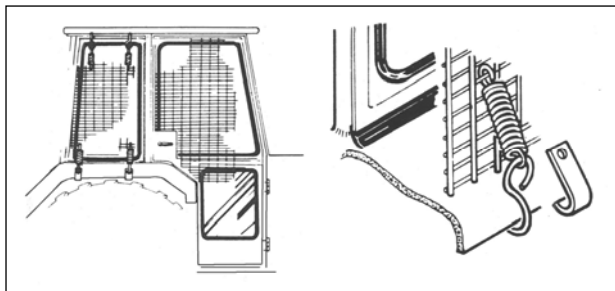

manufacturer can demonstrate that the penetration resistance is equivalent to, or higher than, that provided by mesh/polycarbonate glazing. If the tractor has a roll bar only, a frame must be made to carry both mesh and polycarbonate glazing. The operator should also use personal protective equipment to reduce the risk of serious injury such as; eye protection (mesh visor to EN1731 or safety glasses to EN166), hearing protection to EN352, safety helmet to EN297, gloves, filter mask and high visibility clothing.

Vehicle Ballast: It is imperative when attaching 'third-party' equipment to a vehicle that the maximum possible stability of the machine and vehicle combination is achieved – this can be accomplished by the utilisation of 'ballast' in order to counter-balance the additional equipment added.

Front weights may be required for rear mounted machines to place 15% of total outfit weight on the front axle for stable transport on the road and to reduce 'crabbing' due to the drag of the cutting unit when working on the ground.

Rear weights may be required to maintain a reasonable amount of rear axle load on the opposite wheel from the arms when in work; for normal off-ground work i.e. hedge cutting this should be 20% of rear axle weight or more for adequate control, and for ground work i.e. verge mowing with experienced operators, this can be reduced to 10%.

All factors must be addressed in order to match the type and nature of the equipment added to the circumstances under which it will be used – in the instance of Power Arm hedgecutters it must be remembered that the machines centre of gravity during work will be constantly moving and will differ from that during transport mode, therefore balance becomes critical.

Factors that affect stability:

- Centre of gravity of the tractor/machine combination.
- Geometric conditions, e.g. position of the cutting head and ballast.
- Weight, track width and wheelbase of the tractor.
- Acceleration, braking, turning and the relative position of the cutting head during these operations.
- Ground conditions, e.g. slope, grip, load capability of the soil/surface.
- Rigidity of implement mounting.

Suggestions to increase stability:

- Increasing rear wheel track; a vehicle with a wider wheel track is more stable.
- Ballasting the wheel; it is preferable to use external weights but liquid can be added to around 75% of the tyre volume – water with anti-freeze or the heavier Calcium Chloride alternative can be used.
- Addition of weights – care should be taken in selecting the location of the weights to ensure they are added to a position that offers the greatest advantage.
- Front axle locking (check with tractor manufacturer).

NOTE: The advice above is offered as a guide for stability only and is not a guide to vehicle strength. It is recommended that you consult your vehicle manufacturer or local dealer to obtain specific advice on this subject, additionally advice should be sought from a tyre specialist with regard to tyre pressures and ratings suitable for the type and nature of the machine you intend to fit.

HANDLING THE MACHINE

Lifting Equipment

Suitable overhead lifting equipment with a minimum Safe Working Load (SWL) in excess of the machine's overall weight should be used for handling the machine.

Ensure the machine is kept balanced and level at all times during the lifting procedure. All operatives and bystanders must remain at a safe distance from the raised machine.

Lifting Points

Machines are equipped with 2 lifting points fitted with shackles.

Lifting gear must be evenly attached to both lifting points to ensure machine is balanced and stable during lifting. Keep clear of the raised machine at all times.

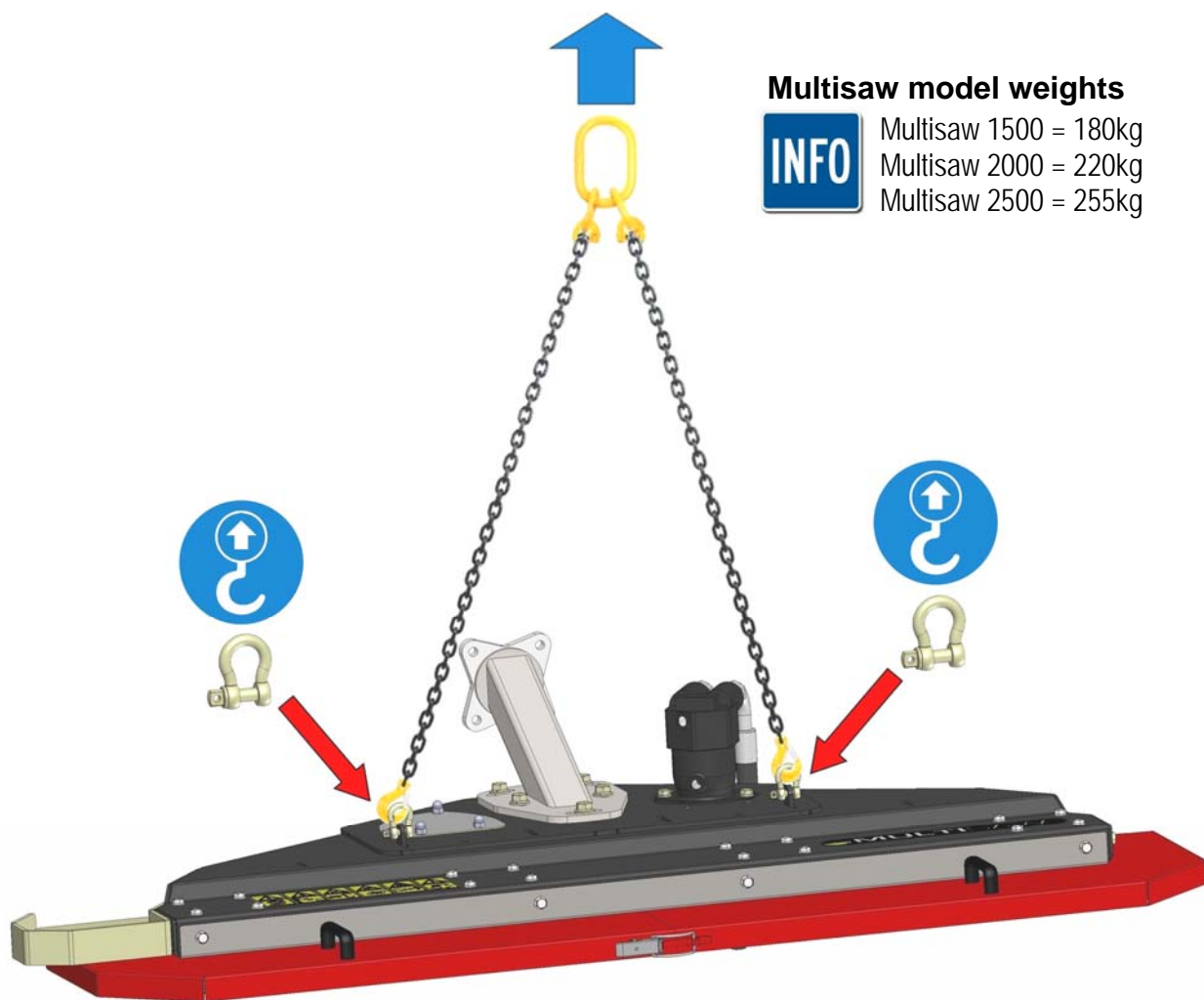

⚠ DANGER

Lifting of the machine should only be performed on a firm level site.

⚠ DANGER

Keep all persons at a safe distance from the raised machine.

MACHINE ATTACHMENT

⚠ WARNING Attachment of the Multisaw must be performed on a firm level site.

Care should be adopted at all times when handling or manoeuvring the machine during the attachment procedure; ensure all persons remain clear of the cutting blades which possess the potential to cause injury even when stationary. For reasons of safety the blade guard should be fitted to machine at all times and only removed for machine operation.

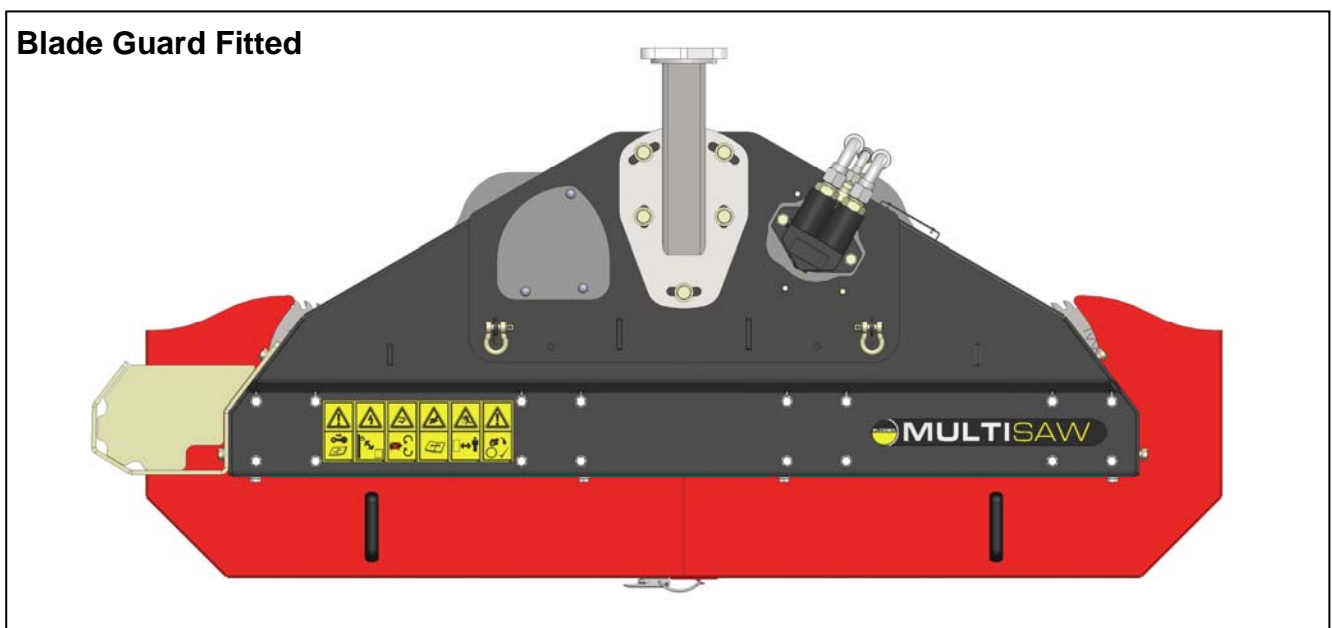
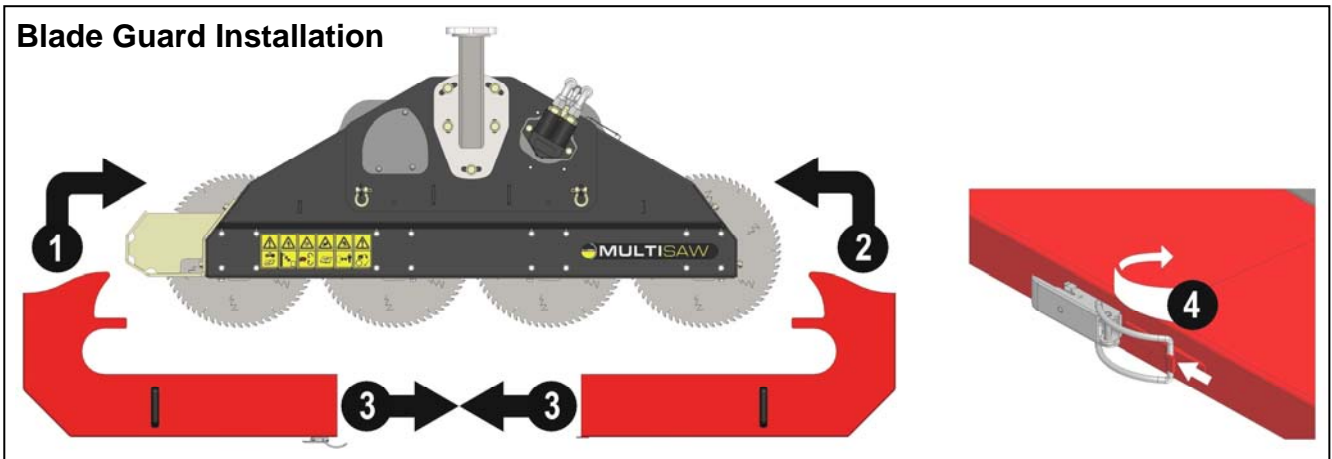

⚠ DANGER Blade guard must always be fitted when attaching the Multisaw.

⚠ DANGER Blade guard must always be fitted when transporting the Multisaw.

⚠ DANGER Blade guard must always be fitted when Multisaw is in storage.

Attachment to Power Arm



Tools required; 24mm spanner, 24mm socket, torque wrench

The Multisaw attaches to the pivot flange of the Power Arm and is secured with four bolts and locknuts; torque locknuts evenly to 203Nm (150 ft.lb).

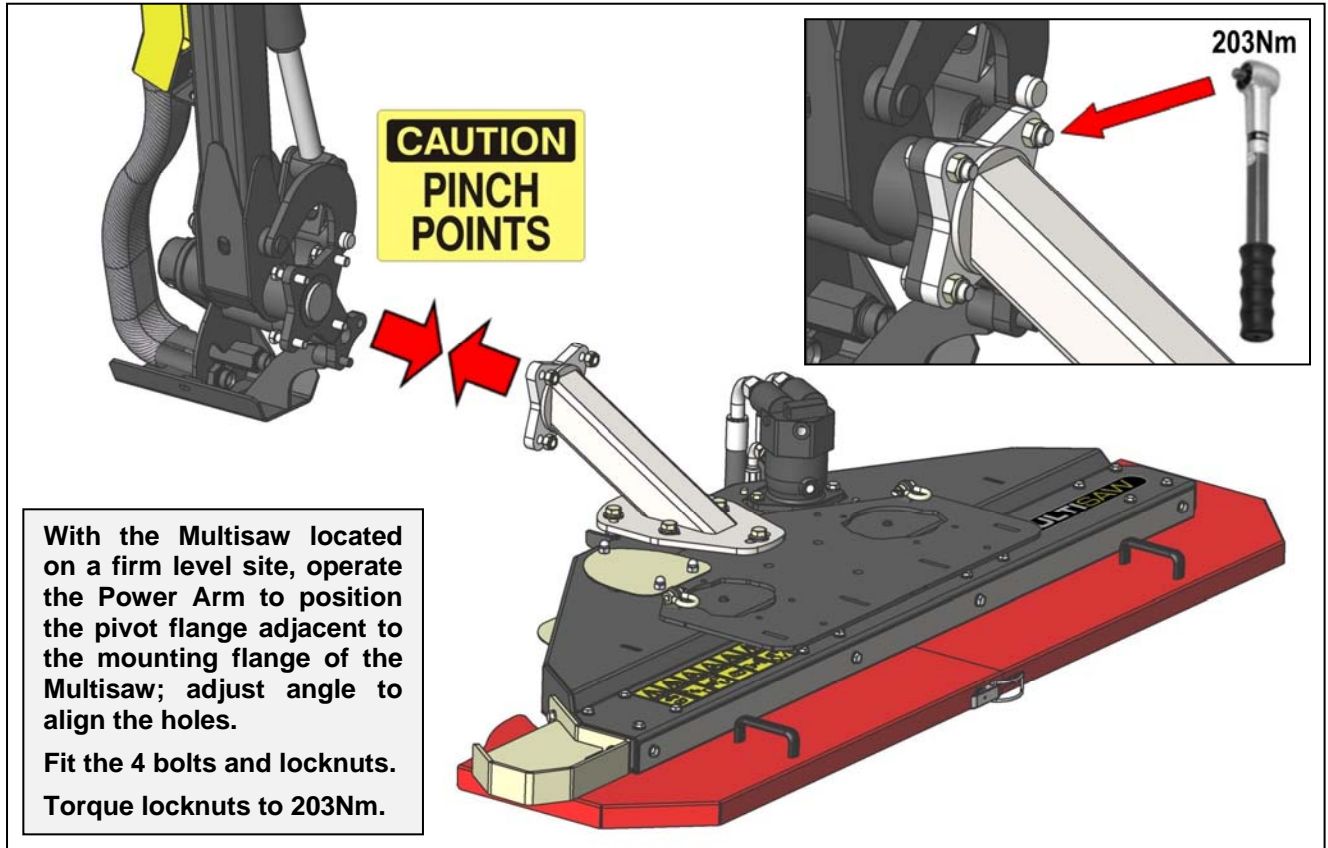

IMPORTANT: Check Multisaw blades are correctly mounted; the blades **MUST** be mounted in a downward cut rotation in relation to the tractors driving direction, see *illustration below*.

Blade Cutting Direction

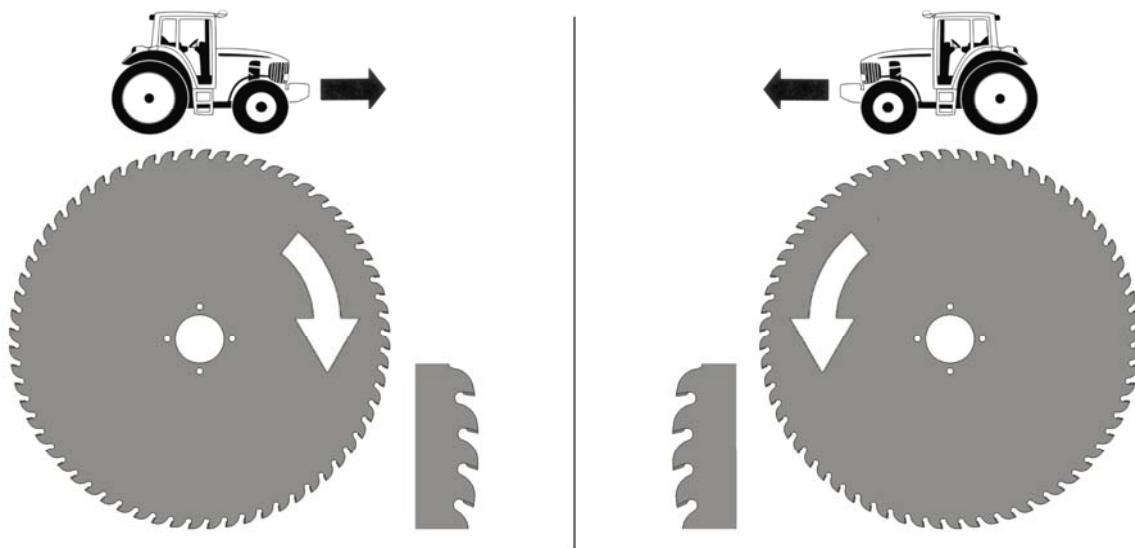

⚠ WARNING

Blades must cut downwards on the leading edge in the direction of tractor travel

Hydraulic Installation

Install and connect hydraulic hoses ensuring the correct cutting direction is achieved. The drain line hose (*max. 1.5 bar*) must be connected directly back to the oil reservoir.

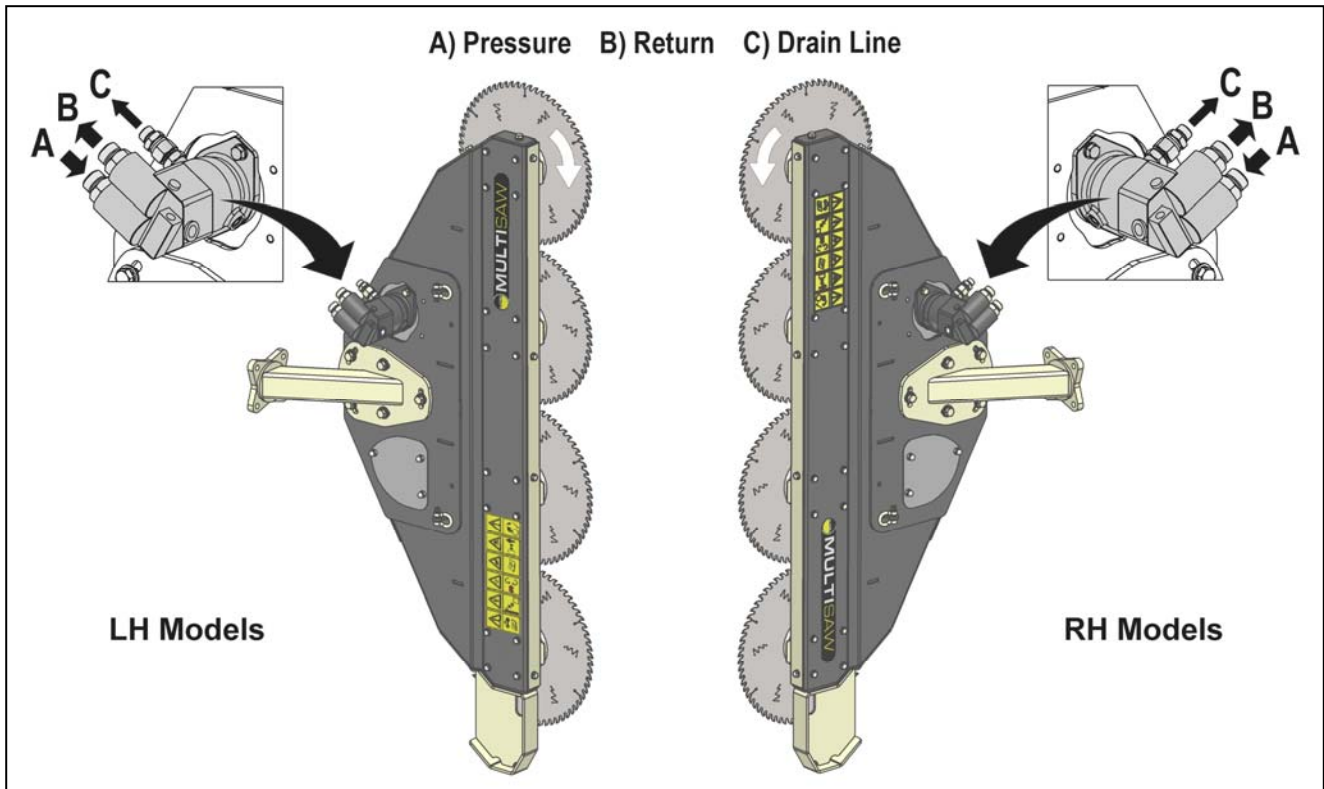

Run the machine to confirm that the blade rotation direction is correct. Switch machine off and inspect the hoses and connections for signs of leaks.

Check belt tension before using the machine for work, *refer to belt tensioning section*.

Belts Access

Access to the belts for checking and/or adjustment requires removal of the lower belt cover.



Tools required; 17mm spanner or socket, belt tension gauge or sonic meter.

⚠ WARNING Avoid contact with blade teeth when accessing belts and adjusters; the edges of blades are dangerous even when stationary.

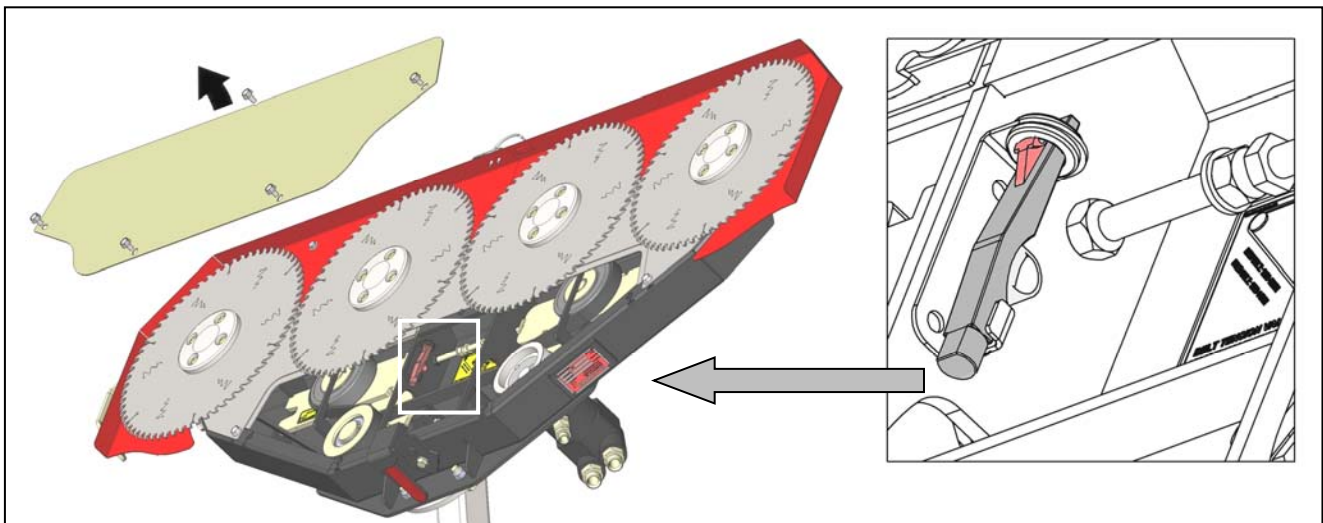

A belt tension gauge is supplied with the machine, this can be found beneath the belt cover in the centre cavity adjacent to belt adjusters. Ensure the gauge is replaced securely in the storage bracket when not in use.

OPERATION

It is recommended that forward speed is kept to a minimum when starting work in order to retain the correct working speed of the blades. Set the angle of the Multisaw at right angles to the work and adjust machine position so that branches meet the saw blades 'straight on'.

Wherever possible try to keep the blades running vertical in relation to the direction of travel, this will help prevent them from 'distorting' during operations.

The machine is equipped with a skid to prevent the lower blade from contacting the ground.

Should small branches, debris or unwanted material get stuck in the blades of the machine, **the machine and the tractor must be switched off and the starting key removed** before attempting to clear the blockage. If necessary, remove the belt cover to gain better access to the blockage; replace cover immediately before starting or using the machine.

⚠ WARNING Never attempt to run the machine with the belt cover removed.

⚠ WARNING Great care must be taken when attempting to clear debris from the blade and/or belt area of the machine; sharp components and numerous pinch risk points exist in these locations. Safety gloves and safety eyewear must be worn and wherever possible the use of a suitable tool should be employed to remove any debris to ensure hands and fingers are kept clear of any risk areas.

When in charge of the machine always obey the following rules;

- Always inspect the work area prior to operation and remove any dangerous materials.
- Never operate the machine with persons or animals in close proximity.
- Stop operations and switch off the machine if persons or animals enter the work zone.
- Ensure all cab guarding is in place and the tractor windows are kept shut.
- Only operate the machine at the correct blade speed.
- Never use the machine in excess of the maximum oil pressure in the hoses.
- Never stop the engine with the PTO engaged.
- Never transport the machine with the PTO engaged.
- Never transport the machine without the blade protection guards fitted.
- Never transport the machine with the blades running.
- Never approach the machine when it is running, always switch it off and stop the tractor.
- Always remove the tractor ignition key before leaving the cab.
- Never use the machine to perform tasks it was not designed for.
- Always lower the machine to rest on the ground with blade protection guards fitted when the unit is parked up or not in use.

MAINTENANCE

⚠ WARNING Beware of blades and belt areas when maintaining and servicing.

Initial Maintenance

- After an initial 2 hours work check tightness of blade bolts.
- After the first day's work, all bolts and screws must be checked and re-tightened.

Routine Maintenance

- Inspect belts and check their tension every 3-5 working hours; *re-tension if required.*
- Check all bolts and screws on a regular basis; *re-tighten as and when required.*
- Remove belt cover and clean the inside of the belt housing.
- Check the condition of hydraulic hoses and connections; *leaking or damaged hydraulic components must be replaced before using the machine.*

Belts

It is vital that all belts are kept in good condition and correctly tensioned at all times.

Checking Belt Tension

The tension of the belts must be checked on a regular basis and adjusted as and when necessary to the specified figures stated in this manual. Tension should be measured at the mid-point positions of the longest belt runs using a belt tension gauge or sonic tension meter.

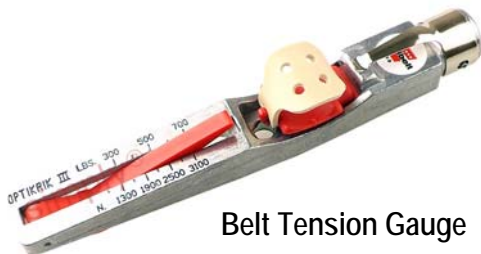

Belt Tension Gauge



Sonic Tension Meter

Tensioning Belts



Tools required; 19mm spanners, belt tension gauge or sonic tension meter

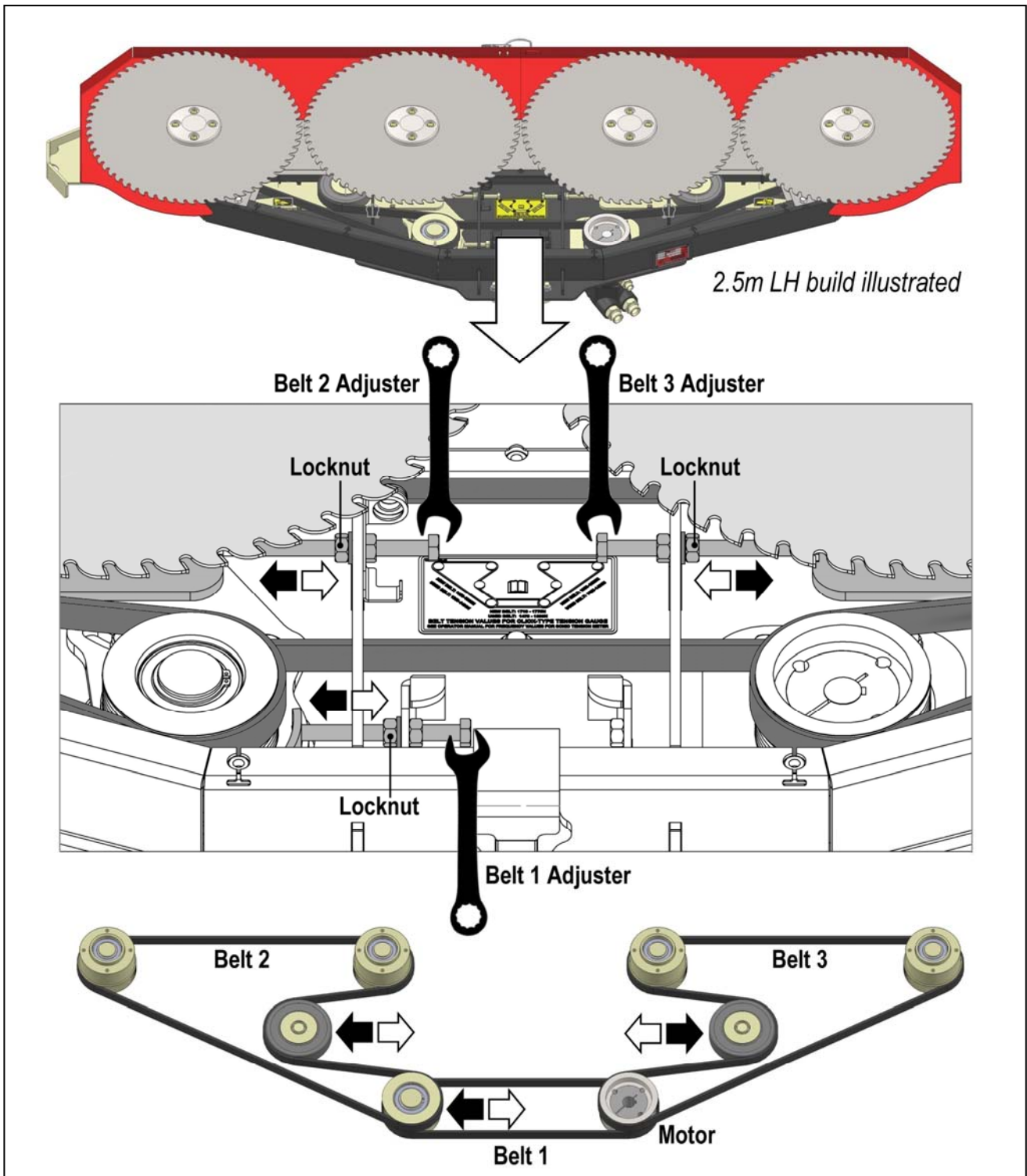

To tension a belt: release the adjuster locknut and rotate adjuster bolt clockwise to increase tension or anti-clockwise to decrease tension. Re-tighten the adjuster locknut when the belt tension is correct – refer to following pages for tension settings.

Belt Tension Settings – 1.5M Multisaws

Multisaw 1.5m LH Build (9550148)

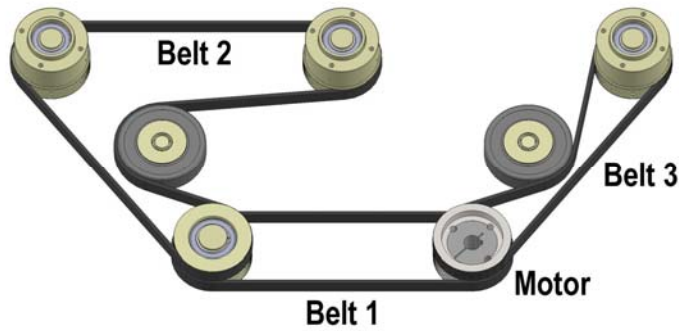

Reference	Part Number	Belt Gauge Tension Setting		Sonic Tension Meter Setting	
		New Belt	Used Belt	New Belt	Used Belt
Belt 1	24159.03	1720 - 1850 N	1480 - 1600 N	105.0 - 108.0 Hz	97.4 - 101.0 Hz
Belt 2	182423	1420 - 1520 N	1220 - 1320 N	91.1 - 94.3 Hz	84.3 - 87.8 Hz
Belt 3	182412	1540 - 1650 N	1320 - 1430 N	94.4 - 97.7 Hz	87.4 - 90.9 Hz

Multisaw 1.5m RH Build (9550147)

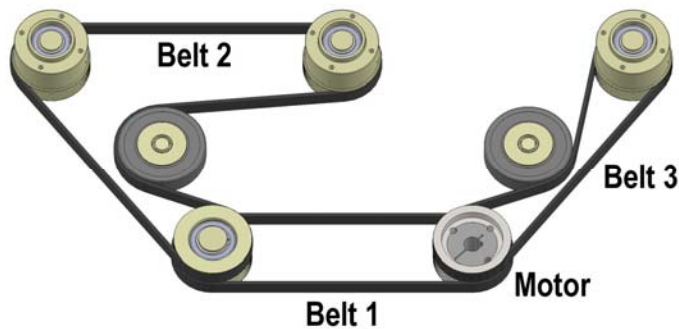

Reference	Part Number	Belt Gauge Tension Setting		Sonic Tension Meter Setting	
		New Belt	Used Belt	New Belt	Used Belt
Belt 1	24159.03	1720 - 1850 N	1480 - 1600 N	105.0 - 108.0 Hz	97.4 - 101.0 Hz
Belt 2	182423	1690 - 1810 N	1450 - 1570 N	99.3 - 102.0 Hz	92.0 - 95.7 Hz
Belt 3	182412	1580 - 1700 N	1360 - 1470 N	95.6 - 99.0 Hz	88.5 - 92.1 Hz

Belt Tension Settings – 2.0M Multisaws

Multisaw 2.0m LH Build (9550122)

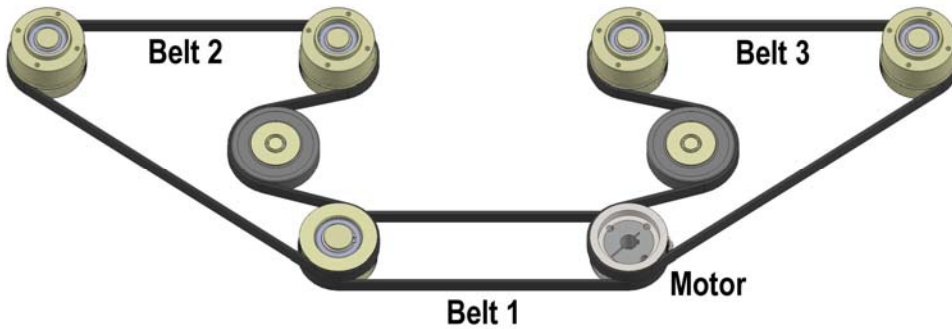

Reference	Part Number	Belt Gauge Tension Setting		Sonic Tension Meter Setting	
		New Belt	Used Belt	New Belt	Used Belt
Belt 1	182187	1710 - 1775 N	1470 - 1530 N	91.3 - 94.5 Hz	84.5 - 88.0 Hz
Belt 2	24159.01	1580 - 1620 N	1350 - 1400 N	70.4 - 72.8 Hz	65.1 - 67.8 Hz
Belt 3	24159.01	1580 - 1620 N	1350 - 1400 N	69.8 - 72.2 Hz	64.6 - 67.2 Hz

Multisaw 2.0m RH Build (9550120)

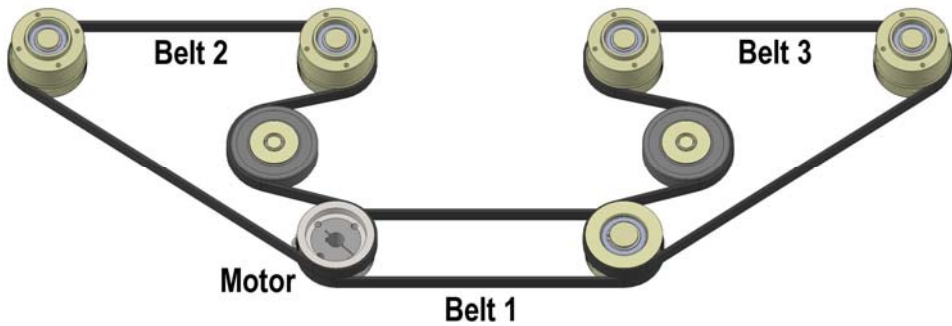

Reference	Part Number	Belt Gauge Tension Setting		Sonic Tension Meter Setting	
		New Belt	Used Belt	New Belt	Used Belt
Belt 1	182187	1710 - 1775 N	1470 - 1530 N	91.3 - 94.5 Hz	84.5 - 88.0 Hz
Belt 2	24159.01	1580 - 1620 N	1350 - 1400 N	69.8 - 72.2 Hz	64.6 - 67.2 Hz
Belt 3	24159.01	1580 - 1620 N	1350 - 1400 N	70.4 - 72.8 Hz	65.1 - 67.8 Hz

Belt Tension Settings – 2.5M Multisaws

Multisaw 2.5m LH Build (9550142)

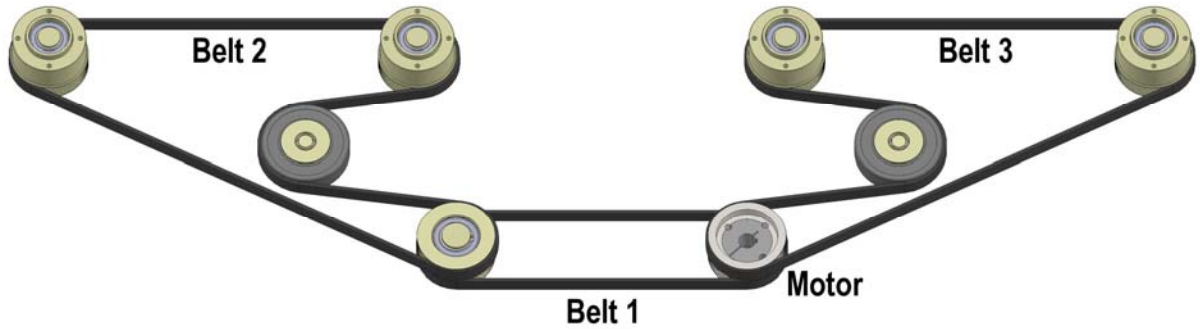

Reference	Part Number	Belt Gauge Tension Setting		Sonic Tension Meter Setting	
		New Belt	Used Belt	New Belt	Used Belt
Belt 1	182187	1710 - 1775 N	1470 - 1530 N	91.3 - 94.5 Hz	84.5 - 88.0 Hz
Belt 2	24159.02	1580 - 1620 N	1350 - 1400 N	56.3 - 58.2 Hz	52.1 - 54.2 Hz
Belt 3	24159.02	1580 - 1620 N	1350 - 1400 N	54.3 - 56.2 Hz	50.3 - 52.3 Hz

Multisaw 2.5m RH Build (9550141)

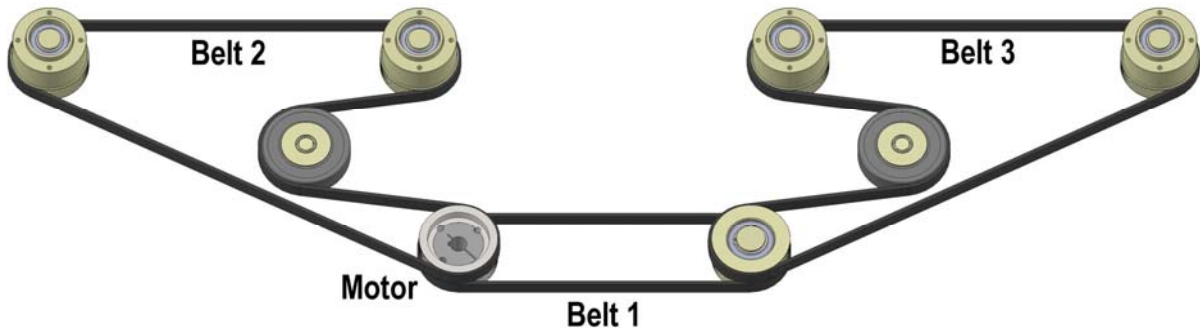

Reference	Part Number	Belt Gauge Tension Setting		Sonic Tension Meter Setting	
		New Belt	Used Belt	New Belt	Used Belt
Belt 1	182187	1710 - 1775 N	1470 - 1530 N	91.3 - 94.5 Hz	84.5 - 88.0 Hz
Belt 2	24159.02	1580 - 1620 N	1350 - 1400 N	54.3 - 56.2 Hz	50.3 - 52.3 Hz
Belt 3	24159.02	1580 - 1620 N	1350 - 1400 N	56.3 - 58.2 Hz	52.1 - 54.2 Hz

Replacing Blades

For safety and performance only use genuine McConnell blades. When replacing blades it is recommended that new blade bolts (P/No. 9300185) are fitted.

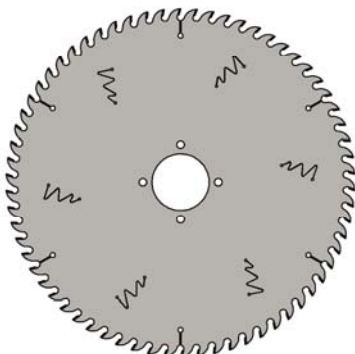

490mm Multisaw Blade
(Part Number 182160)
1.5m & 2.0m Models

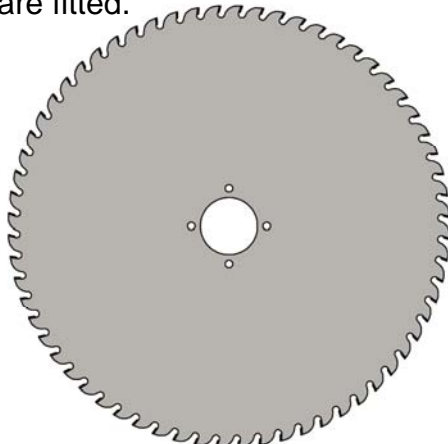

620mm Multisaw Blade
(Part Number 182407)
2.5m Models

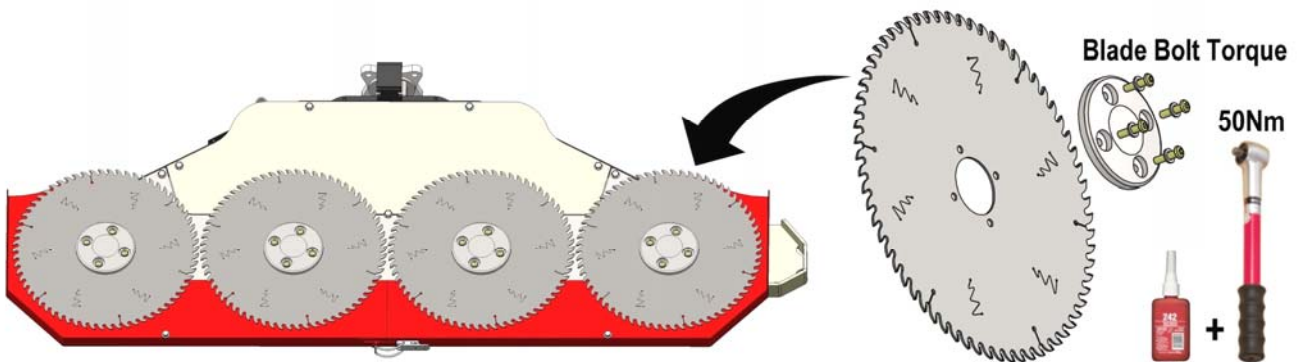

Ensure blades are mounted in the correct cutting direction. Secure blade bolts using medium strength thread-locking adhesive (Loctite 242 or equivalent) and torque to **50Nm (36.9 ft-lb)**.

⚠ WARNING Always check tightness of blade bolts prior to using the machine.

⚠ WARNING Blades must be mounted to cut in a downward direction only.

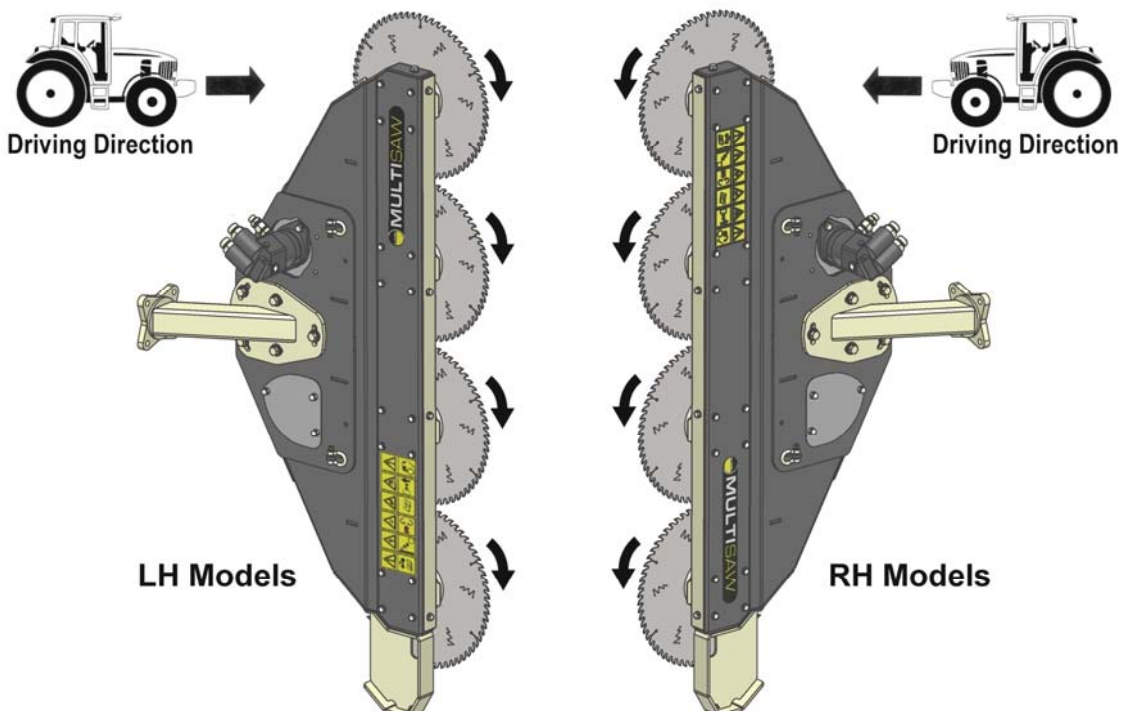



McConnel Limited, Temeside Works, Ludlow, Shropshire SY8 1JL. England.
Telephone: 01584 873131. Facsimile: 01584 876463. www.mcconnel.com